



MUTCD 2000

Manual on Uniform Traffic Control Devices

m i l l e n n i u m e d i t i o n

December 2000



U.S. Department
of Transportation

**Federal Highway
Administration**

The Manual on Uniform Traffic Control Devices (MUTCD) is approved by the Federal Highway Administrator as the National Standard in accordance with Title 23 U.S. Code, Sections 109(d), 114(a), 217, 315, and 402(a), 23 CFR 655, and 49 CFR 1.48(b)(8), 1.48(b)(33), and 1.48(c)(2).

Addresses for Publications Referenced in the MUTCD

American Association of State Highway and Transportation Officials
444 North Capitol Street, NW, Suite 225
Washington, D.C. 20001

American Railway Engineering and Maintenance-of-Way Association
8201 Corporate Dr., Suite 1125
Landover, MD 20785-2230

Illuminating Engineering Society
120 Wall Street, Floor 17
New York, NY 10005

Institute of Makers of Explosives
1120 19th St., NW, Suite 310
Washington, DC 20036-3605

Institute of Transportation Engineers
1099 14th St., NW, Suite 300 West
Washington, D.C. 20005

National Committee on Uniform Traffic Laws and Ordinances
107 S. West St., #110
Alexandria, VA 22314

Transportation Research Board
The National Academies
2101 Constitution Avenue, NW
Washington, D.C. 20418

Acknowledgments

The Federal Highway Administration gratefully acknowledges that valuable assistance that it received from the National Committee on Uniform Traffic Control Devices and its over 200 voluntary members in the development of this Manual.

MANUAL ON UNIFORM TRAFFIC CONTROL DEVICES

INTRODUCTION

Standard:

Traffic control devices shall be defined as all signs, signals, markings, and other devices used to regulate, warn, or guide traffic, placed on, over, or adjacent to a street, highway, pedestrian facility, or bikeway by authority of a public agency having jurisdiction.

The Manual on Uniform Traffic Control Devices (MUTCD) is incorporated by reference in 23 Code of Federal Regulations (CFR), Part 655, Subpart F and shall be recognized as the national standard for traffic control devices on all public roads open to public travel in accordance with 23 U.S.C. 109(d) and 402(a). The policies and procedures of the Federal Highway Administration (FHWA) to obtain basic uniformity of traffic control devices shall be as described in 23 CFR 655, Subpart F.

Any traffic control device design or application provision contained in this Manual shall be considered to be in the public domain. Traffic control devices contained in this Manual shall not be protected by a patent or copyright, except for the Interstate Shield.

Support:

The need for uniform standards was recognized long ago. The American Association of State and Highway Officials (AASHO), now known as the American Association of State Highway and Transportation Officials (AASHTO), published a manual for rural highways in 1927 and the National Conference on Street and Highway Safety (NCSHS) published a manual for urban streets in 1930. In the early years, the necessity for unification of the standards applicable to the different classes of road and street systems was obvious. To meet this need, a joint committee of AASHO and NCSHS developed and published the original edition of this Manual of Uniform Traffic Control Devices (MUTCD) in 1935. That committee, now called the National Committee on Uniform Traffic Control Devices (NCUTCD), though changed from time to time in name, organization, and personnel, has been in continuous existence and has contributed to periodic revisions of this Manual. The FHWA has administered the MUTCD since the 1971 edition. The FHWA and its predecessor organizations have participated in the development and publishing of the previous editions. There were seven previous editions of the MUTCD and several of those editions were revised one or more times. Table I-1 traces the evolution of the MUTCD, including the two manuals developed by AASHO and NCSHS.

Standard:

The U.S. Secretary of Transportation, under authority granted by the Highway Safety Act of 1966, decreed that traffic control devices on all streets and highways open to public travel in accordance with 23 U.S.C. 109(d) and 402(a) in each State

Table I-1. Evolution of the MUTCD

Year	Name	Month / Year Revised
1927	Manual and Specifications for the Manufacture, Display, and Erection of U.S. Standard Road Markers and Signs (for rural roads)	4/29, 12/31
1930	Manual on Street Traffic Signs, Signals, and Markings (for urban streets)	No revisions
1935	Manual on Uniform Traffic Control Devices for Streets and Highways (MUTCD)	2/39
1942	Manual on Uniform Traffic Control Devices for Streets and Highways - War Emergency Edition	No revisions
1948	Manual on Uniform Traffic Control Devices for Streets and Highways	9/54
1961	Manual on Uniform Traffic Control Devices for Streets and Highways	No revisions
1971	Manual on Uniform Traffic Control Devices for Streets and Highways	11/71, 4/72, 3/73, 10/73, 6/74, 6/75, 9/76, 12/77
1978	Manual on Uniform Traffic Control Devices for Streets and Highways	12/79, 12/83, 9/84, 3/86
1988	Manual on Uniform Traffic Control Devices for Streets and Highways	1/90, 3/92, 9/93, 11/94, 12/96, 6/98, 1/00
2000	Manual on Uniform Traffic Control Devices for Streets and Highways - Millennium Edition	

shall be in substantial conformance with the Standards issued or endorsed by the FHWA.

Support:

23 CFR, Part 655.603 adopts the MUTCD as the national standard for any street, highway, or bicycle trail open to public travel in accordance with 23 U.S.C. 109(d) and 402(a). The "Uniform Vehicle Code (UVC)" is one of the documents referenced in the MUTCD. The UVC contains a model set of motor vehicle codes and traffic laws for use throughout the United States. The States are encouraged to adopt Section 15-117 of the UVC which states that, "No person shall install or maintain in any area of private property used by the public any sign, signal, marking, or other device intended to regulate, warn, or guide traffic unless it conforms with the State manual and specifications adopted under Section 15-104." Section 15-104 of the UVC adopts the MUTCD as the standard for conformance.

The Standard, Guidance, Option, and Support material described in this edition of the MUTCD provide the transportation professional with the information needed to make appropriate decisions regarding the use of traffic control devices on streets and highways. The material in this edition is organized to better differentiate between Standards that must be satisfied for the particular circumstances of a situation, Guidance that should be followed for the particular circumstances of a situation, and Options which may be applicable for the particular circumstances of a situation.

Throughout this Manual the headings Standard, Guidance, Option, and Support are used to classify the nature of the text that follows. Figures, tables, and illustrations supplement the text and might constitute a Standard, Guidance, Option, or Support. The user needs to refer to the appropriate text to classify the nature of the figure, table, or illustration.

Standard:

When used in this Manual, the text headings shall be defined as follows:

- 1. Standard - a statement of required, mandatory, or specifically prohibitive practice regarding a traffic control device. All standards are labeled and the text appears in bold large type. The verb shall is typically used. Standards are sometimes modified by Options.**
- 2. Guidance - a statement of recommended, but not mandatory, practice in typical situations, with deviations allowed if engineering judgment or engineering study indicates the deviation to be appropriate. All Guidance statements are labeled and the text appears in large type. Guidance text is the same size as Standard text but it is not bold. The verb should is typically used. Guidance statements are sometimes modified by Options.**
- 3. Option - a statement of practice that is a permissive condition and carries no requirement or recommendation. Options may contain allowable modifications to a Standard or Guidance. All Option statements are labeled and the text appears in small type. The verb may is typically used.**

4. Support - an informational statement that does not convey any degree of mandate, recommendation, authorization, prohibition, or enforceable condition. Support statements are labeled and the text appears in small type. The verbs shall, should, and may are not used in Support statements.

Support:

Throughout this Manual all dimensions and distances are provided in the International System of Units, a modernized version of the Metric system, and their English equivalent units are shown in parentheses.

Guidance:

Before laying out distances or determining sign sizes, the public agency should decide whether to use the International System of Units (Metric) or the English equivalent units. The chosen units should be specified on plan drawings. Care should be given to ensure that the chosen unit of measurement is known to those responsible for designing, installing, or maintaining traffic control devices.

MANUAL ON UNIFORM TRAFFIC CONTROL DEVICES

TABLE OF CONTENTS

	<u>Page</u>
INTRODUCTION Dec., 2000	I-1

PART 1. GENERAL

CHAPTER 1A. GENERAL	Dec., 2000
----------------------------------	-------------------

Section 1A.01	Purpose of Traffic Control Devices.....	1A-1
Section 1A.02	Principles of Traffic Control Devices	1A-1
Section 1A.03	Design of Traffic Control Devices	1A-2
Section 1A.04	Placement and Operation of Traffic Control Devices.....	1A-3
Section 1A.05	Maintenance of Traffic Control Devices.....	1A-3
Section 1A.06	Uniformity of Traffic Control Devices	1A-4
Section 1A.07	Responsibility for Traffic Control Devices	1A-4
Section 1A.08	Authority for Placement of Traffic Control Devices	1A-5
Section 1A.09	Engineering Study and Engineering Judgment.....	1A-6
Section 1A.10	Interpretations, Experimentations, and Changes.....	1A-6
Section 1A.11	Relation to Other Documents.....	1A-10
Section 1A.12	Color Code	1A-12
Section 1A.13	Definitions of Words and Phrases in this Manual.....	1A-13
Section 1A.14	Abbreviations Used on Traffic Control Devices.....	1A-23

PART 2. SIGNS

CHAPTER 2A. GENERAL	Dec., 2000
----------------------------------	-------------------

Section 2A.01	Function and Purpose of Signs.....	2A-1
Section 2A.02	Definitions	2A-1
Section 2A.03	Standardization of Application.....	2A-2
Section 2A.04	Excessive Use of Signs	2A-2
Section 2A.05	Classification of Signs.....	2A-3
Section 2A.06	Design of Signs	2A-3
Section 2A.07	Changeable Message Signs	2A-4
Section 2A.08	Retroreflectivity and Illumination.....	2A-5
Section 2A.09	Minimum Retroreflectivity Levels.....	2A-5
Section 2A.10	Shapes.....	2A-5
Section 2A.11	Sign Colors	2A-8
Section 2A.12	Dimensions	2A-8
Section 2A.13	Symbols	2A-10
Section 2A.14	Word Messages.....	2A-10

MANUAL ON UNIFORM TRAFFIC CONTROL DEVICES

TABLE OF CONTENTS

		<u>Page</u>
Section 2A.15	Sign Borders	2A-11
Section 2A.16	Standardization of Location	2A-11
Section 2A.17	Overhead Sign Installations	2A-20
Section 2A.18	Mounting Height	2A-21
Section 2A.19	Lateral Offset	2A-22
Section 2A.20	Position of Signs.....	2A-23
Section 2A.21	Orientation	2A-24
Section 2A.22	Posts and Mountings	2A-24
Section 2A.23	Maintenance	2A-24
Section 2A.24	Wrong-Way Traffic Control	2A-25

CHAPTER 2B. REGULATORY SIGNSDec., 2000

Section 2B.01	Application of Regulatory Signs	2B-1
Section 2B.02	Design of Regulatory Signs.....	2B-1
Section 2B.03	Size of Regulatory Signs	2B-1
Section 2B.04	STOP Sign (R1-1).....	2B-6
Section 2B.05	STOP Sign Applications	2B-8
Section 2B.06	STOP Sign Placement.....	2B-9
Section 2B.07	Multi-Way Stop Applications	2B-10
Section 2B.08	YIELD Sign (R1-2)	2B-11
Section 2B.09	YIELD Sign Applications.....	2B-12
Section 2B.10	YIELD Sign Placement	2B-12
Section 2B.11	Speed Limit Sign (R2-1)	2B-13
Section 2B.12	Truck Speed Limit Sign (R2-2).....	2B-14
Section 2B.13	Night Speed Limit Sign (R2-3)	2B-14
Section 2B.14	Minimum Speed Limit Sign (R2-4)	2B-14
Section 2B.15	Location of Speed Limit Signs	2B-16
Section 2B.16	Reduced Speed Ahead Signs (R2-5 Series).....	2B-16
Section 2B.17	Turn Prohibition Signs (R3-1 through R3-4)	2B-17
Section 2B.18	Intersection Lane Control Signs (R3-5 through R3-8).....	2B-18
Section 2B.19	Mandatory Movement Lane Control Signs (R3-5, R3-5a, and R3-7).....	2B-20
Section 2B.20	Optional Movement Lane Control Sign (R3-6)	2B-21
Section 2B.21	Advance Intersection Lane Control Signs (R3-8 Series)	2B-22
Section 2B.22	Two-Way Left Turn Only Signs (R3-9a, R3-9b).....	2B-22
Section 2B.23	Reversible Lane Control Signs (R3-9c through R3-9i).....	2B-24
Section 2B.24	DO NOT PASS Sign (R4-1).....	2B-28
Section 2B.25	PASS WITH CARE Sign (R4-2).....	2B-28
Section 2B.26	SLOWER TRAFFIC KEEP RIGHT Sign (R4-3)	2B-28
Section 2B.27	Slow Moving Traffic Lane Signs (R4-5, R4-6)	2B-30
Section 2B.28	Keep Right and Keep Left Signs (R4-7, R4-8).....	2B-30

MANUAL ON UNIFORM TRAFFIC CONTROL DEVICES

TABLE OF CONTENTS

	<u>Page</u>
Section 2B.29	DO NOT ENTER Sign (R5-1)2B-31
Section 2B.30	WRONG WAY Sign (R5-1a).....2B-31
Section 2B.31	Selective Exclusion Signs.....2B-34
Section 2B.32	ONE WAY Signs (R6-1, R6-2).....2B-35
Section 2B.33	Divided Highway Crossing Signs (R6-3, R6-3a).....2B-36
Section 2B.34	Parking, Standing, and Stopping Signs (R7 and R8 Series)2B-37
Section 2B.35	Design of Parking, Standing, and Stopping Signs2B-37
Section 2B.36	Placement of Parking, Stopping, and Standing Signs2B-41
Section 2B.37	Emergency Restriction Signs (R8-4, R8-7, R8-8).....2B-42
Section 2B.38	WALK ON LEFT FACING TRAFFIC and No Hitchhiking Signs (R9-1, R9-4, R9-4a)2B-42
Section 2B.39	Pedestrian Crossing Signs (R9-2, R9-3)2B-42
Section 2B.40	Traffic Signal Signs (R10-1 through R10-13).....2B-44
Section 2B.41	KEEP OFF MEDIAN Sign (R11-1).....2B-47
Section 2B.42	ROAD CLOSED Sign (R11-2) and LOCAL TRAFFIC ONLY Signs (R11-3 Series, R11-4)2B-49
Section 2B.43	Weight Limit Signs (R12-1 through R12-5)2B-49
Section 2B.44	Weigh Station Signs (R13 Series)2B-50
Section 2B.45	Truck Route Sign (R14-1)2B-50
Section 2B.46	Hazardous Cargo Signs (R14-2, R14-3).....2B-52
Section 2B.47	National Network Signs (R14-4, R14-5).....2B-52
Section 2B.48	Preferential Lane Signs (R3-10 through R3-17)2B-52
Section 2B.49	High-Occupancy Vehicle (HOV) Lanes2B-56
Section 2B.50	High-Occupancy Vehicle Sign Applications and Placement.....2B-57
Section 2B.51	Other Regulatory Signs2B-58

CHAPTER 2C. WARNING SIGNSDec., 2000

Section 2C.01	Function of Warning Signs2C-1
Section 2C.02	Application of Warning Signs2C-1
Section 2C.03	Design of Warning Signs2C-1
Section 2C.04	Size of Warning Signs2C-3
Section 2C.05	Placement of Warning Signs.....2C-3
Section 2C.06	Horizontal Alignment Signs (W1-1 through W1-5).....2C-8
Section 2C.07	Combination Horizontal Alignment/Advisory Speed Sign (W1-9)2C-8
Section 2C.08	Combination Horizontal Alignment/Intersection Sign (W1-10).....2C-10
Section 2C.09	One-Direction Large Arrow Sign (W1-6)2C-10
Section 2C.10	Chevron Alignment Sign (W1-8)2C-11
Section 2C.11	Hill Signs (W7-1, W7-1a, W7-1b)2C-12
Section 2C.12	Truck Escape Ramp Signs (W7-4 Series)2C-12
Section 2C.13	ROAD NARROWS Sign (W5-1).....2C-14
Section 2C.14	NARROW BRIDGE Sign (W5-2)2C-14
Section 2C.15	ONE LANE BRIDGE Sign (W5-3)2C-16

MANUAL ON UNIFORM TRAFFIC CONTROL DEVICES

TABLE OF CONTENTS

		<u>Page</u>
Section 2C.16	Divided Highway (Road) Sign (W6-1)	2C-16
Section 2C.17	Divided Highway (Road) Ends Sign (W6-2)	2C-16
Section 2C.18	Double Arrow Sign (W12-1)	2C-17
Section 2C.19	DEAD END/NO OUTLET Signs (W14-1, W14-2)	2C-17
Section 2C.20	Low Clearance Signs (W12-2 and W12-2P)	2C-18
Section 2C.21	BUMP and DIP Signs (W8-1, W8-2)	2C-18
Section 2C.22	SPEED HUMP Sign (W17-1)	2C-20
Section 2C.23	PAVEMENT ENDS Sign (W8-3)	2C-20
Section 2C.24	Shoulder Signs (W8-4, W8-9, W8-9a, and W8-11)	2C-21
Section 2C.25	Slippery When Wet Sign (W8-5)	2C-21
Section 2C.26	Advance Traffic Control Signs (W3-1, W3-2, W3-3, W3-4)	2C-22
Section 2C.27	CROSS TRAFFIC DOES NOT STOP Plaque (W4-4P)	2C-23
Section 2C.28	Merge Sign (W4-1)	2C-24
Section 2C.29	Added Lane Sign (W4-3)	2C-25
Section 2C.30	Lane Ends Signs (W9-1, W9-2)	2C-25
Section 2C.31	Two-Way Traffic Sign (W6-3)	2C-26
Section 2C.32	NO PASSING ZONE Sign (W14-3)	2C-26
Section 2C.33	Advisory Exit, Ramp, and Curve Speed Signs (W13-2, W13-3, W13-5)	2C-26
Section 2C.34	Intersection Warning Signs (W2-1 through W2-6)	2C-28
Section 2C.35	Two-Direction Large Arrow Sign (W1-7)	2C-29
Section 2C.36	Motorized Traffic Signs (W8-6, W11-5, W11-8, W11-10)	2C-30
Section 2C.37	Crossing Signs (W11-1, W11-2, W11-3, W11-4, W16-7P)	2C-30
Section 2C.38	Playground Sign (W15-1)	2C-32
Section 2C.39	Use of Supplemental Plaques	2C-34
Section 2C.40	Design of Supplemental Plaques	2C-34
Section 2C.41	Distance Plaques (W16-2, W16-3, W16-4, W7-3a)	2C-34
Section 2C.42	Advisory Speed Plaque (W13-1)	2C-35
Section 2C.43	Supplemental Arrow Plaques (W16-5P, W16-6P)	2C-35
Section 2C.44	Hill-Related Plaques (W7-2 and W7-3)	2C-35
Section 2C.45	Advance Street Name Plaque (W16-8)	2C-36
Section 2C.46	DEAD END/NO OUTLET Plaques (W14-1P, W14-2P)	2C-36
Section 2C.47	SHARE THE ROAD Plaque (W16-1)	2C-36
CHAPTER 2D.	GUIDE SIGNS – CONVENTIONAL ROADS Dec., 2000	
Section 2D.01	Scope of Conventional Road Guide Sign Standards	2D-1
Section 2D.02	Application	2D-1
Section 2D.03	Color, Retroreflection, and Illumination	2D-1
Section 2D.04	Size of Signs	2D-1
Section 2D.05	Lettering Style	2D-2
Section 2D.06	Size of Lettering	2D-2
Section 2D.07	Amount of Legend	2D-3

MANUAL ON UNIFORM TRAFFIC CONTROL DEVICES

TABLE OF CONTENTS

		<u>Page</u>
Section 2D.08	Arrows	2D-3
Section 2D.09	Numbered Highway Systems	2D-5
Section 2D.10	Route Signs and Auxiliary Signs	2D-6
Section 2D.11	Design of Route Signs.....	2D-6
Section 2D.12	Design of Route Sign Auxiliaries.....	2D-9
Section 2D.13	Junction Auxiliary Sign (M2-1)	2D-10
Section 2D.14	Combination Junction Sign (M2-2)	2D-10
Section 2D.15	Cardinal Direction Auxiliary Signs (M3-1 through M3-4).....	2D-12
Section 2D.16	Auxiliary Signs for Alternative Routes (M4 Series).....	2D-12
Section 2D.17	ALTERNATE Auxiliary Signs (M4-1, M4-1a).....	2D-12
Section 2D.18	BY-PASS Auxiliary Sign (M4-2)	2D-13
Section 2D.19	BUSINESS Auxiliary Sign (M4-3).....	2D-13
Section 2D.20	TRUCK Auxiliary Sign (M4-4)	2D-13
Section 2D.21	TO Auxiliary Sign (M4-5).....	2D-13
Section 2D.22	END Auxiliary Sign (M4-6).....	2D-14
Section 2D.23	TEMPORARY Auxiliary Sign (M4-7).....	2D-14
Section 2D.24	Temporary Detour and Auxiliary Signs	2D-14
Section 2D.25	Advance Turn Arrow Auxiliary Signs (M5-1, M5-2)	2D-15
Section 2D.26	Directional Arrow Auxiliary Signs (M6 Series)	2D-15
Section 2D.27	Route Sign Assemblies.....	2D-15
Section 2D.28	Junction Assembly.....	2D-17
Section 2D.29	Advance Route Turn Assembly.....	2D-21
Section 2D.30	Directional Assembly	2D-22
Section 2D.31	Confirming or Reassurance Assemblies.....	2D-23
Section 2D.32	Trailblazer Assembly	2D-23
Section 2D.33	Destination and Distance Signs.....	2D-24
Section 2D.34	Destination Signs.....	2D-25
Section 2D.35	Location of Destination Signs	2D-27
Section 2D.36	Distance Signs	2D-28
Section 2D.37	Location of Distance Signs	2D-29
Section 2D.38	Street Name Sign (D3)	2D-29
Section 2D.39	Parking Area Sign (D4-1).....	2D-32
Section 2D.40	PARK & RIDE Sign (D4-2).....	2D-32
Section 2D.41	Rest Area Signs (D5 Series).....	2D-33
Section 2D.42	Scenic Area Signs (D6 Series)	2D-35
Section 2D.43	Weigh Station Signing (D8 Series)	2D-35
Section 2D.44	General Service Signs (D9 Series).....	2D-37
Section 2D.45	Reference Posts (D10-1 through D10-3).....	2D-41
Section 2D.46	Traffic Signal Speed Sign (I1-1)	2D-43
Section 2D.47	General Information Signs (I Series)	2D-44
Section 2D.48	Signing of Named Highways	2D-47
Section 2D.49	Trail Signs	2D-48
Section 2D.50	Crossover Signs (D13 Series)	2D-49

MANUAL ON UNIFORM TRAFFIC CONTROL DEVICES

TABLE OF CONTENTS

	<u>Page</u>
CHAPTER 2E. GUIDE SIGNS - FREEWAYS AND EXPRESSWAYS	Dec., 2000
Section 2E.01 Scope of Freeway and Expressway Guide Sign Standards	2E-1
Section 2E.02 Freeway and Expressway Signing Principles	2E-1
Section 2E.03 General	2E-2
Section 2E.04 Color of Guide Signs	2E-2
Section 2E.05 Retroreflectorization or Illumination	2E-3
Section 2E.06 Characteristics of Urban Signing	2E-3
Section 2E.07 Characteristics of Rural Signing	2E-4
Section 2E.08 Memorial Highway Signing	2E-5
Section 2E.09 Amount of Legend on Guide Signs	2E-5
Section 2E.10 Number of Signs at an Overhead Installation	2E-6
Section 2E.11 Sign Spreading and Pull-Through Signs	2E-6
Section 2E.12 Designation of Destinations	2E-8
Section 2E.13 Size and Style of Letters and Signs	2E-9
Section 2E.14 Interline and Edge Spacing	2E-17
Section 2E.15 Sign Borders	2E-18
Section 2E.16 Abbreviations	2E-18
Section 2E.17 Symbols	2E-19
Section 2E.18 Arrows for Interchange Guide Signs	2E-19
Section 2E.19 Diagrammatic Signs	2E-19
Section 2E.20 Signing for Interchange Lane Drops	2E-22
Section 2E.21 Changeable Message Signs	2E-30
Section 2E.22 Overhead Sign Installations	2E-31
Section 2E.23 Lateral Clearance	2E-31
Section 2E.24 Guide Sign Classification	2E-32
Section 2E.25 Route Signs and Trailblazer Assemblies	2E-33
Section 2E.26 Signs for Intersections At Grade	2E-35
Section 2E.27 Interchange Guide Signs	2E-35
Section 2E.28 Interchange Exit Numbering	2E-36
Section 2E.29 Interchange Classification	2E-41
Section 2E.30 Advance Guide Signs	2E-41
Section 2E.31 Next Exit Supplemental Sign	2E-43
Section 2E.32 Other Supplemental Guide Signs	2E-44
Section 2E.33 Exit Direction Signs	2E-45
Section 2E.34 Exit Gore Signs	2E-49
Section 2E.35 Post-Interchange Signs	2E-49
Section 2E.36 Distance Signs	2E-51
Section 2E.37 Interchange Sequence Signs	2E-52
Section 2E.38 Community Interchanges Identification Signs	2E-55
Section 2E.39 NEXT X EXITS Sign	2E-56
Section 2E.40 Signing by Type of Interchange	2E-56

MANUAL ON UNIFORM TRAFFIC CONTROL DEVICES

TABLE OF CONTENTS

	<u>Page</u>
Section 2E.41	Freeway-to-Freeway Interchange2E-57
Section 2E.42	Cloverleaf Interchange.....2E-59
Section 2E.43	Cloverleaf Interchange with Collector-Distributor Roadways.....2E-59
Section 2E.44	Partial Cloverleaf Interchange2E-61
Section 2E.45	Diamond Interchange.....2E-61
Section 2E.46	Urban Diamond Interchange.....2E-64
Section 2E.47	Closely-Spaced Interchanges.....2E-66
Section 2E.48	Minor Interchange.....2E-66
Section 2E.49	Approaches and Connecting Roadways2E-68
Section 2E.50	Wrong-Way Traffic Control at Interchange Ramps.....2E-68
Section 2E.51	General Service Signs.....2E-71
Section 2E.52	Rest and Scenic Area Signs2E-76
Section 2E.53	Tourist Information and Welcome Centers.....2E-77
Section 2E.54	Reference Posts.....2E-79
Section 2E.55	Miscellaneous Guide Signs.....2E-79
Section 2E.56	Radio Information Signing2E-80
Section 2E.57	Carpool Information Signing.....2E-81
Section 2E.58	Weigh Station Signing2E-82
CHAPTER 2F.	SPECIFIC SERVICE SIGNSDec., 2000
Section 2F.01	Eligibility.....2F-1
Section 2F.02	Application.....2F-3
Section 2F.03	Logos and Logo Panels.....2F-6
Section 2F.04	Number and Size of Logos and Signs2F-6
Section 2F.05	Size of Lettering.....2F-7
Section 2F.06	Signs at Interchanges2F-7
Section 2F.07	Single-Exit Interchanges2F-8
Section 2F.08	Double-Exit Interchanges2F-8
Section 2F.09	Signs at Intersections2F-9
Section 2F.10	Signing Policy2F-10
CHAPTER 2G.	TOURIST-ORIENTED DIRECTIONAL SIGNS (TODS)Dec., 2000
Section 2G.01	Purpose and Application.....2G-1
Section 2G.02	Design.....2G-2
Section 2G.03	Style and Size of Lettering.....2G-3
Section 2G.04	Arrangement and Size of Signs.....2G-3
Section 2G.05	Advance Signs2G-5
Section 2G.06	Sign Locations2G-7
Section 2G.07	State Policy2G-7

MANUAL ON UNIFORM TRAFFIC CONTROL DEVICES

TABLE OF CONTENTS

	<u>Page</u>
CHAPTER 2H. RECREATIONAL AND CULTURAL INTEREST AREA SIGNS	Dec., 2000
Section 2H.01 Scope	2H-1
Section 2H.02 Application of Recreational and Cultural Interest Area Signs.....	2H-1
Section 2H.03 Regulatory and Warning Signs.....	2H-2
Section 2H.04 General Design Requirements for Recreational and Cultural Interest Area Symbol Signs.....	2H-2
Section 2H.05 Symbol Sign Sizes.....	2H-4
Section 2H.06 Use of Educational Plaques.....	2H-4
Section 2H.07 Use of Prohibitive Slash.....	2H-4
Section 2H.08 Placement of Recreational and Cultural Interest Area Symbol Signs	2H-6
Section 2H.09 Destination Guide Signs.....	2H-12
CHAPTER 2I. EMERGENCY MANAGEMENT SIGNING	Dec., 2000
Section 2I.01 Emergency Management.....	2I-1
Section 2I.02 Design of Emergency Management Signs.....	2I-1
Section 2I.03 EVACUATION ROUTE Sign (EM-1)	2I-2
Section 2I.04 AREA CLOSED Sign (EM-2).....	2I-4
Section 2I.05 TRAFFIC CONTROL POINT Sign (EM-3)	2I-4
Section 2I.06 MAINTAIN TOP SAFE SPEED Sign (EM-4).....	2I-5
Section 2I.07 ROAD (AREA) USE PERMIT REQUIRED FOR THRU TRAFFIC Sign (EM-5).....	2I-5
Section 2I.08 Emergency Aid Center Signs (EM-6 Series).....	2I-6
Section 2I.09 Shelter Directional Signs (EM-7 Series)	2I-6
 PART 3. MARKINGS	
CHAPTER 3A. GENERAL	Dec., 2000
Section 3A.01 Functions and Limitations.....	3A-1
Section 3A.02 Standardization of Application.....	3A-1
Section 3A.03 Materials	3A-2
Section 3A.04 Colors	3A-2
Section 3A.05 Colors of Longitudinal Pavement Markings	3A-3
Section 3A.06 Widths and Patterns of Longitudinal Pavement Markings	3A-3

MANUAL ON UNIFORM TRAFFIC CONTROL DEVICES

TABLE OF CONTENTS

		<u>Page</u>
CHAPTER 3B.	PAVEMENT AND CURB MARKINGS	Dec., 2000
Section 3B.01	Yellow Centerline and Left Edge Line Pavement Markings and Warrants	3B-1
Section 3B.02	No-Passing Zone Pavement Markings and Warrants	3B-6
Section 3B.03	Other Yellow Longitudinal Pavement Markings	3B-11
Section 3B.04	White Lane Line and Right Edge Line Pavement Markings and Warrants	3B-14
Section 3B.05	Other White Longitudinal Pavement Markings	3B-15
Section 3B.06	Edge Line Pavement Markings	3B-19
Section 3B.07	Warrants for Use of Edge Lines	3B-21
Section 3B.08	Extensions Through Intersections or Interchanges	3B-22
Section 3B.09	Lane Reduction Transition Markings	3B-22
Section 3B.10	Approach Markings for Obstructions	3B-26
Section 3B.11	Raised Pavement Markers	3B-27
Section 3B.12	Raised Pavement Markers as Vehicle Positioning Guides with Other Longitudinal Markings	3B-29
Section 3B.13	Raised Pavement Markers Supplementing Other Markings	3B-30
Section 3B.14	Raised Pavement Markers Substituting for Pavement Markings.....	3B-31
Section 3B.15	Transverse Markings	3B-32
Section 3B.16	Stop and Yield Lines.....	3B-32
Section 3B.17	Crosswalk Markings	3B-34
Section 3B.18	Parking Space Markings	3B-37
Section 3B.19	Pavement Word and Symbol Markings	3B-37
Section 3B.20	Speed Measurement Markings	3B-48
Section 3B.21	Curb Markings	3B-48
Section 3B.22	Preferential Lane Word and Symbol Markings	3B-49
Section 3B.23	Preferential Lane Longitudinal Markings for Motorized Vehicles ...	3B-50
Section 3B.24	Markings for Roundabouts	3B-55
Section 3B.25	Markings for Other Circular Intersections	3B-56
Section 3B.26	Speed Hump Markings	3B-56
Section 3B.27	Advance Speed Hump Markings.....	3B-59
CHAPTER 3C.	OBJECT MARKERS	Dec., 2000
Section 3C.01	Object Marker Design and Placement Height	3C-1
Section 3C.02	Markings for Objects in the Roadway.....	3C-3
Section 3C.03	Markings for Objects Adjacent to the Roadway	3C-3
Section 3C.04	End-of-Roadway Markings	3C-4

MANUAL ON UNIFORM TRAFFIC CONTROL DEVICES

TABLE OF CONTENTS

		<u>Page</u>
CHAPTER 3D.	DELINEATORS	Dec., 2000
Section 3D.01	Delineators.....	3D-1
Section 3D.02	Delineator Design.....	3D-1
Section 3D.03	Delineator Application	3D-1
Section 3D.04	Delineator Placement and Spacing.....	3D-3
CHAPTER 3E.	COLORED PAVEMENTS	Dec., 2000
Section 3E.01	General.....	3E-1
CHAPTER 3F.	BARRICADES AND CHANNELIZING DEVICES	Dec., 2000
Section 3F.01	Barricades.....	3F-1
Section 3F.02	Channelizing Devices	3F-1
CHAPTER 3G.	ISLANDS	Dec., 2000
Section 3G.01	General	3G-1
Section 3G.02	Approach-End Treatment	3G-1
Section 3G.03	Island Marking Application.....	3G-2
Section 3G.04	Island Marking Colors.....	3G-2
Section 3G.05	Island Object Markers	3G-3
Section 3G.06	Island Delineators.....	3G-3
 PART 4. HIGHWAY TRAFFIC SIGNALS		
CHAPTER 4A.	GENERAL	Dec., 2000
Section 4A.01	Types.....	4A-1
Section 4A.02	Definitions Relating to Highway Traffic Signals.....	4A-1
CHAPTER 4B.	TRAFFIC CONTROL SIGNALS - GENERAL	Dec., 2000
Section 4B.01	General.....	4B-1
Section 4B.02	Basis of Installation or Removal of Traffic Control Signals.....	4B-1
Section 4B.03	Advantages and Disadvantages of Traffic Control Signals.....	4B-2
Section 4B.04	Alternatives to Traffic Control Signals	4B-3
Section 4B.05	Adequate Roadway Capacity	4B-4

MANUAL ON UNIFORM TRAFFIC CONTROL DEVICES

TABLE OF CONTENTS

		<u>Page</u>
CHAPTER 4C.	TRAFFIC CONTROL SIGNAL NEEDS STUDIESDec., 2000	
Section 4C.01	Studies and Factors for Justifying Traffic Control Signals	4C-1
Section 4C.02	Warrant 1, Eight-Hour Vehicular Volume	4C-3
Section 4C.03	Warrant 2, Four-Hour Vehicular Volume.....	4C-6
Section 4C.04	Warrant 3, Peak Hour	4C-6
Section 4C.05	Warrant 4, Pedestrian Volume	4C-8
Section 4C.06	Warrant 5, School Crossing	4C-11
Section 4C.07	Warrant 6, Coordinated Signal System	4C-12
Section 4C.08	Warrant 7, Crash Experience	4C-12
Section 4C.09	Warrant 8, Roadway Network	4C-13
CHAPTER 4D.	TRAFFIC CONTROL SIGNAL FEATURESDec., 2000	
Section 4D.01	General	4D-1
Section 4D.02	Responsibility For Operation and Maintenance.....	4D-2
Section 4D.03	Provisions For Pedestrians	4D-3
Section 4D.04	Meaning of Vehicular Signal Indications.....	4D-3
Section 4D.05	Application of Steady Signal Indications.....	4D-6
Section 4D.06	Application of Steady Signal Indications For Left Turns	4D-8
Section 4D.07	Application of Steady Signal Indications For Right Turns	4D-11
Section 4D.08	Prohibited Steady Signal Indications	4D-14
Section 4D.09	Unexpected Conflicts During Green or Yellow Intervals	4D-14
Section 4D.10	Yellow Change and Red Clearance Intervals.....	4D-15
Section 4D.11	Application of Flashing Signal Indications.....	4D-16
Section 4D.12	Flashing Operation of Traffic Control Signals.....	4D-17
Section 4D.13	Preemption and Priority Control of Traffic Control Signals.....	4D-19
Section 4D.14	Coordination of Traffic Control Signals	4D-21
Section 4D.15	Size, Number, and Location of Signal Faces by Approach	4D-22
Section 4D.16	Number and Arrangement of Signal Sections in Vehicular Traffic Control Signal Faces	4D-28
Section 4D.17	Visibility, Shielding, and Positioning of Signal Faces	4D-30
Section 4D.18	Design, Illumination, and Color of Signal Sections	4D-33
Section 4D.19	Lateral Placement of Signal Supports and Cabinets	4D-34
Section 4D.20	Temporary Traffic Control Signals	4D-35
Section 4D.21	Traffic Signal Signs, Auxiliary.....	4D-36
CHAPTER 4E.	PEDESTRIAN CONTROL FEATURESDec., 2000	
Section 4E.01	Pedestrian Signal Heads	4E-1
Section 4E.02	Meaning of Pedestrian Signal Indications.....	4E-1
Section 4E.03	Application of Pedestrian Signal Heads	4E-2
Section 4E.04	Size, Design, and Illumination of Pedestrian Signal Indications	4E-2

MANUAL ON UNIFORM TRAFFIC CONTROL DEVICES

TABLE OF CONTENTS

		<u>Page</u>
Section 4E.05	Location and Height of Pedestrian Signal Heads.....	4E-3
Section 4E.06	Accessible Pedestrian Signals.....	4E-5
Section 4E.07	Pedestrian Detectors	4E-8
Section 4E.08	Accessible Pedestrian Signal Detectors.....	4E-10
Section 4E.09	Pedestrian Intervals and Signal Phases.....	4E-12
CHAPTER 4F.	TRAFFIC CONTROL SIGNALS FOR EMERGENCY VEHICLE ACCESSDec., 2000
Section 4F.01	Applications of Emergency-Vehicle Traffic Control Signals	4F-1
Section 4F.02	Design of Emergency-Vehicle Traffic Control Signals	4F-1
Section 4F.03	Operation of Emergency-Vehicle Traffic Control Signals.....	4F-2
CHAPTER 4G.	TRAFFIC CONTROL SIGNALS FOR ONE-LANE, TWO-WAY FACILITIESDec., 2000
Section 4G.01	Application of Traffic Control Signals for One-Lane, Two-Way Facilities.....	4G-1
Section 4G.02	Design of Traffic Control Signals for One-Lane, Two-Way Facilities.....	4G-1
Section 4G.03	Operation of Traffic Control Signals for One-Lane, Two-Way Facilities.....	4G-2
CHAPTER 4H.	TRAFFIC CONTROL SIGNALS FOR FREEWAY ENTRANCE RAMPSDec., 2000
Section 4H.01	Application of Freeway Entrance Ramp Control Signals.....	4H-1
Section 4H.02	Design of Freeway Entrance Ramp Control Signals	4H-2
CHAPTER 4I.	TRAFFIC CONTROL FOR MOVABLE BRIDGESDec., 2000
Section 4I.01	Application of Traffic Control for Movable Bridges	4I-1
Section 4I.02	Design and Location of Movable Bridge Signals and Gates	4I-2
Section 4I.03	Operation of Movable Bridge Signals and Gates	4I-4
CHAPTER 4J.	LANE-USE CONTROL SIGNALSDec., 2000
Section 4J.01	Application of Lane-Use Control Signals	4J-1
Section 4J.02	Meaning of Lane-Use Control Signal Indications.....	4J-2
Section 4J.03	Design of Lane-Use Control Signals.....	4J-3
Section 4J.04	Operation of Lane-Use Control Signals	4J-5

MANUAL ON UNIFORM TRAFFIC CONTROL DEVICES

TABLE OF CONTENTS

		<u>Page</u>
CHAPTER 4K.	FLASHING BEACONSDec., 2000
Section 4K.01	General Design and Operation of Flashing Beacons	4K-1
Section 4K.02	Intersection Control Beacon	4K-1
Section 4K.03	Warning Beacon	4K-2
Section 4K.04	Speed Limit Sign Beacon	4K-3
Section 4K.05	Stop Beacon	4K-4
CHAPTER 4L.	IN-ROADWAY LIGHTSDec., 2000
Section 4L.01	Application of In-Roadway Lights	4L-1
Section 4L.02	In-Roadway Warning Lights at Crosswalks	4L-1
 PART 5. TRAFFIC CONTROL DEVICES FOR LOW-VOLUME ROADS 		
CHAPTER 5A.	GENERALDec., 2000
Section 5A.01	Function	5A-1
Section 5A.02	Application	5A-2
Section 5A.03	Design	5A-2
Section 5A.04	Placement	5A-4
CHAPTER 5B.	REGULATORY SIGNSDec., 2000
Section 5B.01	Introduction	5B-1
Section 5B.02	STOP and YIELD Signs (R1-1 and R1-2)	5B-1
Section 5B.03	Speed Limit Signs (R2 Series)	5B-1
Section 5B.04	Traffic Movement and Prohibition Signs (R3, R4, R5, R6, R9, R10, R11, R12, R13, and R14 Series)	5B-3
Section 5B.05	Parking Signs (R8 Series)	5B-3
Section 5B.06	Other Regulatory Signs	5B-3
CHAPTER 5C.	WARNING SIGNSDec., 2000
Section 5C.01	Introduction	5C-1
Section 5C.02	Horizontal Alignment Signs (W1-1 through W1-8)	5C-1
Section 5C.03	Intersection Warning Signs (W2-1 through W2-5)	5C-1
Section 5C.04	Stop Ahead and Yield Ahead Signs (W3-1a, W3-2a)	5C-1
Section 5C.05	Narrow Bridge Sign (W5-2a)	5C-4
Section 5C.06	ONE LANE BRIDGE Sign (W5-3)	5C-4

MANUAL ON UNIFORM TRAFFIC CONTROL DEVICES

TABLE OF CONTENTS

		<u>Page</u>
Section 5C.07	Hill Sign (W7-1a).....	5C-4
Section 5C.08	PAVEMENT ENDS Sign (W8-3).....	5C-5
Section 5C.09	Motorized Traffic and Crossing Signs (W11 Series and W8-6)	5C-5
Section 5C.10	Advisory Speed Plaque (W13-1).....	5C-5
Section 5C.11	DEAD END and NO OUTLET Plaques and Signs (W14-1P, W14-2P, W14-1, and W14-2).....	5C-6
Section 5C.12	NO TRAFFIC SIGNS Sign (W16-2)	5C-6
Section 5C.13	Other Warning Signs.....	5C-6
CHAPTER 5D.	GUIDE SIGNSDec., 2000
Section 5D.01	Introduction	5D-1
CHAPTER 5E.	MARKINGSDec., 2000
Section 5E.01	Introduction.....	5E-1
Section 5E.02	Centerline Markings	5E-1
Section 5E.03	Edge Line Markings	5E-1
Section 5E.04	Delineators	5E-2
Section 5E.05	Object Markers	5E-2
Section 5E.06	Other Markings	5E-2
CHAPTER 5F.	TRAFFIC CONTROL FOR HIGHWAY-RAIL GRADE CROSSINGSDec., 2000
Section 5F.01	Introduction	5F-1
Section 5F.02	Highway-Rail Grade Crossing (Crossbuck) Sign (R15-1, R15-2).....	5F-1
Section 5F.03	Highway-Rail Grade Crossing Advance Warning Signs (W10 Series).....	5F-1
Section 5F.04	STOP and YIELD Signs	5F-3
Section 5F.05	Pavement Markings.....	5F-3
Section 5F.06	Other Traffic Control Devices	5F-3
CHAPTER 5G.	TEMPORARY TRAFFIC CONTROL ZONESDec., 2000
Section 5G.01	Introduction	5G-1
Section 5G.02	Applications.....	5G-3
Section 5G.03	Channelization Devices.....	5G-3
Section 5G.04	Markings.....	5G-3
Section 5G.05	Other Traffic Control Devices.....	5G-4

MANUAL ON UNIFORM TRAFFIC CONTROL DEVICES

TABLE OF CONTENTS

		<u>Page</u>
 PART 6. TEMPORARY TRAFFIC CONTROL		
CHAPTER 6A.	GENERAL	Dec., 2000
Section 6A.01	General	6A-1
CHAPTER 6B.	FUNDAMENTAL PRINCIPLES	Dec., 2000
Section 6B.01	Fundamental Principles of Temporary Traffic Control	6B-1
CHAPTER 6C.	TEMPORARY TRAFFIC CONTROL ELEMENTS Dec., 2000	
Section 6C.01	Temporary Traffic Control Plans	6C-1
Section 6C.02	Temporary Traffic Control Zones	6C-2
Section 6C.03	Components of Temporary Traffic Control Zones	6C-3
Section 6C.04	Advance Warning Area	6C-3
Section 6C.05	Transition Area	6C-5
Section 6C.06	Activity Area	6C-6
Section 6C.07	Termination Area	6C-7
Section 6C.08	Tapers	6C-9
Section 6C.09	Detours and Diversions	6C-11
Section 6C.10	One-Lane, Two-Way Traffic Control	6C-11
Section 6C.11	Flagger Method of One-Lane, Two-Way Traffic Control	6C-13
Section 6C.12	Flag Transfer Method of One-Lane, Two-Way Traffic Control	6C-13
Section 6C.13	Pilot Car Method of One-Lane, Two-Way Traffic Control	6C-14
Section 6C.14	Temporary Traffic Control Signal Method of One-Lane, Two-Way Traffic Control	6C-14
Section 6C.15	Stop or Yield Control Method of One-Lane, Two-Way Traffic Control	6C-14
CHAPTER 6D.	PEDESTRIAN AND WORKER SAFETY	Dec., 2000
Section 6D.01	Pedestrian Considerations	6D-1
Section 6D.02	Worker Considerations	6D-4
CHAPTER 6E.	FLAGGER CONTROL	Dec., 2000
Section 6E.01	Qualifications for Flaggers	6E-1
Section 6E.02	High-Visibility Clothing	6E-1
Section 6E.03	Hand-Signaling Devices	6E-2
Section 6E.04	Flagger Procedures	6E-3
Section 6E.05	Flagger Stations	6E-5

MANUAL ON UNIFORM TRAFFIC CONTROL DEVICES

TABLE OF CONTENTS

		<u>Page</u>
CHAPTER 6F.	TEMPORARY TRAFFIC CONTROL	
	ZONE DEVICES	Dec., 2000
Section 6F.01	Types of Devices	6F-1
Section 6F.02	General Characteristics of Signs	6F-1
Section 6F.03	Sign Placement	6F-3
Section 6F.04	Sign Maintenance	6F-7
Section 6F.05	Regulatory Sign Authority	6F-7
Section 6F.06	Regulatory Sign Design	6F-7
Section 6F.07	Regulatory Sign Applications	6F-7
Section 6F.08	ROAD (STREET) CLOSED Sign (R11-2)	6F-11
Section 6F.09	Local Traffic Only Signs (R11-3a, R11-4)	6F-11
Section 6F.10	Weight Limit Signs (R12-1, R12-2, R12-5)	6F-12
Section 6F.11	STAY IN LANE Sign (R4-9)	6F-12
Section 6F.12	PEDESTRIAN CROSSWALK Sign (R9-8)	6F-12
Section 6F.13	SIDEWALK CLOSED Signs (R9-9, R9-10, R9-11, R9-11a)	6F-12
Section 6F.14	Special Regulatory Signs	6F-13
Section 6F.15	Warning Sign Function, Design, and Application	6F-13
Section 6F.16	Position of Advance Warning Signs	6F-21
Section 6F.17	ROAD (STREET) WORK Sign (W20-1)	6F-22
Section 6F.18	DETOUR Sign (W20-2)	6F-22
Section 6F.19	ROAD (STREET) CLOSED Sign (W20-3)	6F-23
Section 6F.20	ONE LANE ROAD Sign (W20-4)	6F-23
Section 6F.21	LANE(S) CLOSED Signs (W20-5, W20-5a)	6F-23
Section 6F.22	CENTER LANE CLOSED AHEAD Signs (W9-3, W9-3a)	6F-24
Section 6F.23	THRU TRAFFIC MERGE RIGHT (LEFT) Sign (W4-1a)	6F-24
Section 6F.24	Lane Reduction Sign (W4-2)	6F-24
Section 6F.25	ON RAMP Plaque (W13-4)	6F-24
Section 6F.26	RAMP NARROWS Sign (W5-4)	6F-24
Section 6F.27	SLOW TRAFFIC AHEAD Sign (W23-1)	6F-25
Section 6F.28	EXIT OPEN, EXIT CLOSED Signs (E5-2, E5-2a)	6F-25
Section 6F.29	Flagger Sign (W20-7, W20-7a)	6F-25
Section 6F.30	Two-Way Traffic Sign (W6-3)	6F-25
Section 6F.31	Workers Sign (W21-1, W21-1a)	6F-26
Section 6F.32	FRESH OIL (TAR) Sign (W21-2)	6F-26
Section 6F.33	ROAD MACHINERY AHEAD Sign (W21-3)	6F-26
Section 6F.34	SHOULDER WORK Signs (W21-5, W21-5a, W21-5b)	6F-26
Section 6F.35	SURVEY CREW Sign (W21-6)	6F-27
Section 6F.36	UTILITY WORK Sign (W21-7)	6F-27
Section 6F.37	Signs for Blasting Areas	6F-28
Section 6F.38	BLASTING ZONE AHEAD Sign (W22-1)	6F-28
Section 6F.39	TURN OFF 2-WAY RADIO AND PHONE Sign (W22-2)	6F-28
Section 6F.40	END BLASTING ZONE Sign (W22-3)	6F-29

MANUAL ON UNIFORM TRAFFIC CONTROL DEVICES

TABLE OF CONTENTS

		<u>Page</u>
Section 6F.41	SHOULDER DROP-OFF Sign (W8-9a).....	6F-29
Section 6F.42	UNEVEN LANES Sign (W8-11).....	6F-29
Section 6F.43	NO CENTER STRIPE Sign (W8-12).....	6F-29
Section 6F.44	Other Warning Signs.....	6F-29
Section 6F.45	Advisory Speed Plaque (W13-1).....	6F-30
Section 6F.46	Supplementary Distance Plaque (W7-3a).....	6F-30
Section 6F.47	Guide Signs.....	6F-31
Section 6F.48	ROAD WORK NEXT XX KM (MILES) Sign (G20-1).....	6F-32
Section 6F.49	END ROAD WORK Sign (G20-2a).....	6F-32
Section 6F.50	Detour Signs and Markers (M4-8, M4-8a, M4-8b, M4-9, and M4-10).....	6F-32
Section 6F.51	PILOT CAR FOLLOW ME Sign (G20-4).....	6F-33
Section 6F.52	Portable Changeable Message Signs.....	6F-33
Section 6F.53	Arrow Panels.....	6F-36
Section 6F.54	High-Level Warning Devices (Flag Trees).....	6F-40
Section 6F.55	Channelizing Devices.....	6F-41
Section 6F.56	Cones.....	6F-44
Section 6F.57	Tubular Markers.....	6F-45
Section 6F.58	Vertical Panels.....	6F-46
Section 6F.59	Drums.....	6F-47
Section 6F.60	Type I, II, or III Barricades.....	6F-48
Section 6F.61	Direction Indicator Barricades.....	6F-50
Section 6F.62	Temporary Traffic Barriers as Channelizing Devices.....	6F-51
Section 6F.63	Temporary Raised Islands.....	6F-51
Section 6F.64	Opposing Traffic Lane Divider.....	6F-52
Section 6F.65	Pavement Markings.....	6F-52
Section 6F.66	Temporary Pavement Markings.....	6F-53
Section 6F.67	Raised Pavement Markers.....	6F-54
Section 6F.68	Delineators.....	6F-55
Section 6F.69	Lighting Devices.....	6F-55
Section 6F.70	Floodlights.....	6F-56
Section 6F.71	Flashing Warning Beacons.....	6F-56
Section 6F.72	Warning Lights.....	6F-57
Section 6F.73	Steady-Burn Electric Lamps.....	6F-58
Section 6F.74	Temporary Traffic Control Signals.....	6F-59
Section 6F.75	Temporary Traffic Barriers.....	6F-61
Section 6F.76	Crash Cushions.....	6F-62
Section 6F.77	Vehicle-Arresting Systems.....	6F-63
Section 6F.78	Rumble Strips.....	6F-64
Section 6F.79	Screens.....	6F-64
Section 6F.80	Future and Experimental Devices.....	6F-65

MANUAL ON UNIFORM TRAFFIC CONTROL DEVICES

TABLE OF CONTENTS

	<u>Page</u>
CHAPTER 6G. TYPE OF TEMPORARY TRAFFIC CONTROL ZONE ACTIVITIES	Dec., 2000
Section 6G.01 Typical Applications	6G-1
Section 6G.02 Work Duration	6G-1
Section 6G.03 Location of Work	6G-5
Section 6G.04 Modifications to Fulfill Special Needs	6G-5
Section 6G.05 Work Outside of Shoulder	6G-7
Section 6G.06 Work on the Shoulder with No Encroachment	6G-8
Section 6G.07 Work on the Shoulder with Minor Encroachment	6G-9
Section 6G.08 Work Within the Median	6G-10
Section 6G.09 Work Within the Traveled Way of Two-Lane Highways	6G-10
Section 6G.10 Work Within the Traveled Way of Urban Streets	6G-11
Section 6G.11 Work Within the Traveled Way of Multi-Lane, Non-Access Controlled Highways	6G-12
Section 6G.12 Work Within the Traveled Way at an Intersection	6G-14
Section 6G.13 Work Within the Traveled Way of Expressways and Freeways	6G-16
Section 6G.14 Two-Lane, Two-Way Traffic on One Roadway of a Normally Divided Highway	6G-17
Section 6G.15 Crossovers	6G-18
Section 6G.16 Interchanges	6G-18
Section 6G.17 Movable Barriers	6G-19
Section 6G.18 Work in the Vicinity of Highway-Rail Grade Crossings	6G-19
Section 6G.19 Control of Traffic Through Incident Areas	6G-19
CHAPTER 6H. TYPICAL APPLICATIONS	Dec., 2000
Section 6H.01 Typical Applications	6H-1
 PART 7. TRAFFIC CONTROLS FOR SCHOOL AREAS	
CHAPTER 7A. GENERAL	Dec., 2000
Section 7A.01 Need for Standards	7A-1
Section 7A.02 School Routes and Established School Crossings	7A-3
Section 7A.03 School Crossing Control Criteria	7A-3
Section 7A.04 Scope	7A-4
Section 7A.05 Application of Standards	7A-4
Section 7A.06 Engineering Study Required	7A-4
Section 7A.07 Maintenance of Traffic Control Devices	7A-4
Section 7A.08 Placement Authority	7A-5

MANUAL ON UNIFORM TRAFFIC CONTROL DEVICES

TABLE OF CONTENTS

	<u>Page</u>
Section 7A.09	Removal of Confusing Advertising.....7A-5
Section 7A.10	Meaning of Standard, Guidance, Option, and Support.....7A-5
CHAPTER 7B.	SIGNSDec., 2000
Section 7B.01	Size of School Signs.....7B-1
Section 7B.02	Illumination and Reflectorization.....7B-1
Section 7B.03	Position of Signs.....7B-1
Section 7B.04	Height of Signs.....7B-3
Section 7B.05	Installation of Signs.....7B-3
Section 7B.06	Lettering.....7B-3
Section 7B.07	Sign Color for School Warning Signs.....7B-3
Section 7B.08	School Advance Warning Sign (S1-1).....7B-4
Section 7B.09	School Crosswalk Warning Assembly (S1-1 with Diagonal Arrow) ..7B-4
Section 7B.10	SCHOOL BUS STOP AHEAD Sign (S3-1).....7B-7
Section 7B.11	School Speed Limit Assembly (S4-1, S4-2, S4-3, S4-4, S5-1).....7B-7
Section 7B.12	School Reduced Speed Ahead Assembly.....7B-8
Section 7B.13	END SCHOOL ZONE Sign (S5-2).....7B-9
Section 7B.14	Parking and Stopping Signs (R7 and R8 Series).....7B-9
CHAPTER 7C.	MARKINGSDec., 2000
Section 7C.01	Functions and Limitations.....7C-1
Section 7C.02	Standardization of Application.....7C-1
Section 7C.03	Crosswalk Markings.....7C-1
Section 7C.04	Stop Line Markings.....7C-2
Section 7C.05	Curb Markings for Parking Regulations.....7C-2
Section 7C.06	Pavement Word and Symbol Markings.....7C-3
CHAPTER 7D.	SIGNALSDec., 2000
Section 7D.01	General.....7D-1
CHAPTER 7E.	CROSSING SUPERVISIONDec., 2000
Section 7E.01	Types of Crossing Supervision.....7E-1
Section 7E.02	Adult Guards.....7E-1
Section 7E.03	Qualifications of Adult Guards.....7E-1
Section 7E.04	Uniform of Adult Guards and Student Patrols.....7E-2
Section 7E.05	Operating Procedures for Adult Guards.....7E-2
Section 7E.06	Police Officers.....7E-2
Section 7E.07	Student Patrols.....7E-3

MANUAL ON UNIFORM TRAFFIC CONTROL DEVICES

TABLE OF CONTENTS

	<u>Page</u>
Section 7E.08	Choice of Student Patrols7E-3
Section 7E.09	Operating Procedures for Student Patrols7E-3
CHAPTER 7F.	GRADE-SEPARATED CROSSINGSDec., 2000
Section 7F.01	Function.....7F-1
Section 7F.02	Types of Grade-Separated Crossings7F-1
Section 7F.03	Criteria for Use of Grade-Separated Crossings7F-1

PART 8. TRAFFIC CONTROLS FOR HIGHWAY-RAIL GRADE CROSSINGS

CHAPTER 8A.	GENERALDec., 2000
Section 8A.01	Introduction8A-1
Section 8A.02	Use of Standard Devices, Systems, and Practices8A-4
Section 8A.03	Uniform Provisions8A-4
Section 8A.04	Highway-Rail Grade Crossing Elimination8A-5
Section 8A.05	Temporary Traffic Control Zones8A-5
CHAPTER 8B.	SIGNS AND MARKINGSDec., 2000
Section 8B.01	Purpose8B-1
Section 8B.02	Highway-Rail Grade Crossing (Crossbuck) Sign (R15-1, R15-2).....8B-1
Section 8B.03	Highway-Rail Grade Crossing Advance Warning Signs (W10 Series)8B-3
Section 8B.04	EXEMPT Highway-Rail Grade Crossing Signs (R15-3, W10-1a).....8B-5
Section 8B.05	Turn Restrictions During Preemption.....8B-6
Section 8B.06	DO NOT STOP ON TRACKS Sign (R8-8).....8B-6
Section 8B.07	STOP or YIELD Signs at Highway-Rail Grade Crossings8B-7
Section 8B.08	TRACKS OUT OF SERVICE Sign (R8-9)8B-7
Section 8B.09	Emergency Notification Sign (I-13 or I-13a).....8B-8
Section 8B.10	TRAINS MAY EXCEED 130 km/h (80 MPH) Sign (W10-8, W10-8a)8B-9
Section 8B.11	NO TRAIN HORN Sign (W10-9).....8B-9
Section 8B.12	NO SIGNAL Sign (W10-10).....8B-9
Section 8B.13	LOOK Sign (R15-8).....8B-9
Section 8B.14	Low Ground Clearance Highway-Rail Grade Crossing Sign (W10-5)8B-11
Section 8B.15	Storage Space Signs (W10-11, W10-11a, W10-11b)8B-11
Section 8B.16	Pavement Markings8B-12

MANUAL ON UNIFORM TRAFFIC CONTROL DEVICES

TABLE OF CONTENTS

		<u>Page</u>
Section 8B.17	Stop Lines	8B-15
Section 8B.18	Dynamic Envelope Delineation.....	8B-15
CHAPTER 8C.	ILLUMINATIONDec., 2000
Section 8C.01	Illumination at Highway-Rail Grade Crossings	8C-1
CHAPTER 8D.	FLASHING-LIGHT SIGNALS, GATES, AND TRAFFIC CONTROL SIGNALSDec., 2000
Section 8D.01	Introduction	8D-1
Section 8D.02	Flashing-Light Signals, Post-Mounted.....	8D-3
Section 8D.03	Flashing-Light Signals, Overhead Structures	8D-4
Section 8D.04	Automatic Gates	8D-5
Section 8D.05	Four-Quadrant Gate Systems	8D-6
Section 8D.06	Train Detection.....	8D-9
Section 8D.07	Traffic Control Signals at or Near Highway-Rail Grade Crossings	8D-10
PART 9. TRAFFIC CONTROLS FOR BICYCLE FACILITIES		
CHAPTER 9A.	GENERALDec., 2000
Section 9A.01	Requirements for Bicyclist Traffic Control Devices.....	9A-1
Section 9A.02	Scope	9A-1
Section 9A.03	Definitions Relating to Bicycles	9A-1
Section 9A.04	Maintenance	9A-2
Section 9A.05	Relation to Other Documents.....	9A-2
Section 9A.06	Placement Authority	9A-3
Section 9A.07	Meaning of Standard, Guidance, Option, and Support.....	9A-3
Section 9A.08	Colors	9A-3
CHAPTER 9B.	SIGNSDec., 2000
Section 9B.01	Application and Placement of Signs	9B-1
Section 9B.02	Design of Bicycle Signs	9B-2
Section 9B.03	STOP and YIELD Signs (R1-1, R1-2)	9B-4
Section 9B.04	Bicycle Lane Signs (R3-16, R3-17)	9B-4
Section 9B.05	BEGIN RIGHT TURN LANE YIELD TO BIKES Sign (R4-4)	9B-6
Section 9B.06	NO MOTOR VEHICLES Sign (R5-3).....	9B-6

MANUAL ON UNIFORM TRAFFIC CONTROL DEVICES

TABLE OF CONTENTS

		<u>Page</u>
Section 9B.07	Bicycle Prohibition Sign (R5-6).....	9B-6
Section 9B.08	No Parking Bicycle Lane Signs (R7-9, R7-9a).....	9B-7
Section 9B.09	Bicycle Regulatory Signs (R9-5, R9-6).....	9B-7
Section 9B.10	Shared-Use Path Restriction Sign (R9-7).....	9B-7
Section 9B.11	Other Regulatory Signs	9B-7
Section 9B.12	Turn or Curve Warning Signs (W1 Series)	9B-8
Section 9B.13	Intersection Warning Signs (W2 Series)	9B-8
Section 9B.14	Bicycle Surface Condition Warning Sign (W8-10).....	9B-8
Section 9B.15	Bicycle Crossing Warning Sign (W11-1).....	9B-11
Section 9B.16	Other Bicycle Warning Signs	9B-11
Section 9B.17	Bicycle Route Guide Signs (D11-1).....	9B-12
Section 9B.18	Bicycle Route Markers (M1-8, M1-9)	9B-12
Section 9B.19	Destination Arrow and Supplemental Plaque Signs for Bicycle Route Signs.....	9B-16
Section 9B.20	Bicycle Parking Area Sign (D4-3)	9B-17
CHAPTER 9C.	MARKINGSDec., 2000
Section 9C.01	Functions of Markings.....	9C-1
Section 9C.02	General Principles.....	9C-1
Section 9C.03	Marking Patterns and Colors on Shared-Use Paths	9C-3
Section 9C.04	Markings for Bicycle Lanes	9C-3
Section 9C.05	Word Messages and Symbols Applied to the Pavement.....	9C-5
Section 9C.06	Object Markers on Shared-Use Paths.....	9C-5
Section 9C.07	Pavement Markings for Obstructions.....	9C-10
CHAPTER 9D.	SIGNALSDec., 2000
Section 9D.01	Application	9D-1
Section 9D.02	Signal Operations for Bicycles.....	9D-1
PART 10. TRAFFIC CONTROLS FOR HIGHWAY-		
LIGHT RAIL TRANSIT GRADE CROSSINGS		
CHAPTER 10A.	GENERALDec., 2000
Section 10A.01	Introduction	10A-1
Section 10A.02	Use of Standard Devices, Systems, and Practices	10A-2
Section 10A.03	Uniform Provisions	10A-2
Section 10A.04	Highway-Light Rail Transit Grade Crossing Elimination	10A-3
Section 10A.05	Temporary Traffic Control Zones	10A-3

MANUAL ON UNIFORM TRAFFIC CONTROL DEVICES

TABLE OF CONTENTS

		<u>Page</u>
CHAPTER 10B.	HIGHWAY-LIGHT RAIL TRANSIT GRADE CROSSING CONTROL SYSTEMS	Dec., 2000
Section 10B.01	Introduction.....	10B-1
CHAPTER 10C.	SIGNS, ILLUMINATION, AND MARKINGS	Dec., 2000
Section 10C.01	Introduction.....	10C-1
Section 10C.02	LOOK Sign (R15-8).....	10C-1
Section 10C.03	STOP or YIELD Signs (R1-1, R1-2, W3-1a, W3-2a).....	10C-1
Section 10C.04	DO NOT STOP ON TRACKS Sign (R8-8).....	10C-2
Section 10C.05	STOP HERE ON RED Sign (R10-6).....	10C-2
Section 10C.06	Light Rail Transit-Activated Blank-Out Turn Prohibition Signs (R3-1a , R3-2a).....	10C-4
Section 10C.07	Divided Highway With Light Rail Transit Crossing Signs (R15-7 Series).....	10C-4
Section 10C.08	No Vehicles On Tracks Signs (R15-6, R15-6a).....	10C-5
Section 10C.09	Light Rail Transit Only Lane Signs (R15-4 Series).....	10C-5
Section 10C.10	Do Not Pass Light Rail Transit Signs (R15-5, R15-5a).....	10C-6
Section 10C.11	Highway-Rail Advance Warning Signs (W10 Series).....	10C-8
Section 10C.12	Light Rail Transit Approaching-Activated Blank-Out Warning Sign (W10-7).....	10C-9
Section 10C.13	Light Rail Station Sign (I-12).....	10C-9
Section 10C.14	Illumination at Highway-Light Rail Transit Crossings.....	10C-9
Section 10C.15	Dynamic Envelope Delineation Markings.....	10C-9
CHAPTER 10D.	HIGHWAY-LIGHT RAIL TRANSIT ACTIVE TRAFFIC CONTROL GRADE CROSSING SYSTEMS	Dec., 2000
Section 10D.01	Introduction.....	10D-1
Section 10D.02	Four-Quadrant Gate Systems.....	10D-2
Section 10D.03	Automatic Gates.....	10D-3
Section 10D.04	Flashing-Light Signals.....	10D-4
Section 10D.05	Traffic Control Signals.....	10D-5
Section 10D.06	Traffic Signal Preemption Turning Restrictions.....	10D-6
Section 10D.07	Use of Traffic Control Signals for Control of Light Rail Transit Vehicles at Grade Crossings.....	10D-7
Section 10D.08	Pedestrian and Bicycle Signals and Crossings.....	10D-9
Appendix A1	Congressional Legislation	Dec., 2000
	Congressional Legislation.....	A1-1

MANUAL ON UNIFORM TRAFFIC CONTROL DEVICES

LIST OF FIGURES

		<u>Page</u>
PART 1. GENERAL		
CHAPTER 1A. GENERAL		
Figure 1A-1	Typical Process for Requesting and Conducting Experimentations for New Traffic Control Devices.....	1A-8
Figure 1A-2	Typical Process for Incorporating New Traffic Control Devices into the MUTCD	1A-11
PART 2. SIGNS		
CHAPTER 2A. GENERAL		
Figure 2A-1	Height and Lateral Location of Signs for Typical Installations.....	2A-12
Figure 2A-2	Typical Locations for Signs at Intersections	2A-13
Figure 2A-3	Typical ONE WAY Signing for Divided Highways With Medians Less Than 9 m (30 ft)	2A-14
Figure 2A-4	Typical ONE WAY Signing for Divided Highways With Medians Greater Than 9 m (30 ft)	2A-15
Figure 2A-5	Typical Locations of ONE WAY Signs	2A-16
Figure 2A-6	Typical Locations of ONE WAY Signs	2A-17
Figure 2A-7	Typical Application of Warning Signs	2A-18
CHAPTER 2B. REGULATORY SIGNS		
Figure 2B-1	Location of Reversible Two-Way Left-Turn Signs	2B-25
Figure 2B-2	Typical Wrong-Way Signing for Divided Highways	2B-33
CHAPTER 2D. GUIDE SIGNS - CONVENTIONAL ROADS		
Figure 2D-1	Arrows for Use on Guide Signs	2D-4
Figure 2D-2	Illustration of Directional Assemblies and Other Route Signs	2D-18
Figure 2D-3	Typical Weigh Station Signing.....	2D-36
CHAPTER 2E. GUIDE SIGNS - FREEWAYS AND EXPRESSWAYS		
Figure 2E-1	Example of Guide Sign Spreading	2E-7
Figure 2E-2	Pull-Through Signs	2E-7
Figure 2E-3	Diagrammatic Sign for Single-Lane Left Exit	2E-21
Figure 2E-4	Diagrammatic Signs for Split With Dedicated Lanes	2E-23

MANUAL ON UNIFORM TRAFFIC CONTROL DEVICES

LIST OF FIGURES

		<u>Page</u>
Figure 2E-5	Diagrammatic Signs for Split With Optional Lane	2E-24
Figure 2E-6	Diagrammatic Signs for Two-Lane Exit with Optional Lane and Route Discontinuity	2E-25
Figure 2E-7	Diagrammatic Signs for Two-Lane Exit with Optional Lane	2E-26
Figure 2E-8	EXIT27 ONLY on Left with Diagrammatic Sign for Left Lane Dropped at Interchange	2E-27
Figure 2E-9	EXIT ONLY Panels for Right Lane Dropped at an Interchange.....	2E-29
Figure 2E-10	Typical Interchange Numbering for Mainline and Circumferential Routes	2E-38
Figure 2E-11	Typical Interchange Numbering for Mainline, Loop, and Spur Routes	2E-39
Figure 2E-12	Typical Interchange Numbering If Routes Overlap	2E-40
Figure 2E-13	Typical Interchange Advance Guide Signs.....	2E-42
Figure 2E-14	Next Exit Supplemental Advance Guide Signs	2E-44
Figure 2E-15	Supplemental Guide Signs for Multi-Exit Interchanges	2E-46
Figure 2E-16	Supplemental Guide Sign for a Park and Ride Facility (Route without Exit Numbering)	2E-46
Figure 2E-17	Supplemental Guide Sign for a Park and Ride Facility (Route with Exit Numbering)	2E-47
Figure 2E-18	Interchange Exit Direction Sign	2E-47
Figure 2E-19	Exit Gore Signs.....	2E-50
Figure 2E-20	Post-Interchange Distance Sign	2E-51
Figure 2E-21	Signing of Closely-Spaced Interchanges Using Interchange Sequence Signs	2E-53
Figure 2E-22	Interchange Sequence Sign.....	2E-54
Figure 2E-23	Community Interchanges Identification Sign.....	2E-54
Figure 2E-24	NEXT EXITS Sign	2E-54
Figure 2E-25	Typical Freeway-to-Freeway Interchange Guide Signs	2E-58
Figure 2E-26	Typical Guide Signs for Full Cloverleaf Interchange	2E-60
Figure 2E-27	Typical Partial Cloverleaf Interchange Guide Signs	2E-62
Figure 2E-28	Typical Diamond Interchange Guide Signs.....	2E-63
Figure 2E-29	Typical Urban Diamond Interchange Guide Signs.....	2E-65
Figure 2E-30	Typical Minor Interchange Guide Signs.....	2E-67
Figure 2E-31	Typical Regulatory Signing and Pavement Markings at Exit Ramp Termination to Deter Wrong-Way Entry	2E-69
Figure 2E-32	Typical Regulatory Signing and Pavement Markings at Entrance Ramp Terminal Where Design Does Not Clearly Indicate the Direction of Flow	2E-70
Figure 2E-33	Typical General Service Signs (without Exit Numbering).....	2E-72
Figure 2E-34	Typical General Service Signs (with Exit Numbering).....	2E-72
Figure 2E-35	Typical Next Services Sign.....	2E-72

MANUAL ON UNIFORM TRAFFIC CONTROL DEVICES

LIST OF FIGURES

		<u>Page</u>
Figure 2E-36	Typical Rest Area Gore Sign	2E-72
 CHAPTER 2F. SPECIFIC SERVICE SIGNS		
Figure 2F-1	Typical Specific Service Signs.....	2F-4
Figure 2F-2	Typical Specific Service Sign Locations	2F-5
 CHAPTER 2G. TOURIST-ORIENTED DIRECTIONAL SIGNS		
Figure 2G-1	Typical Tourist-Oriented Directional Signs	2G-4
Figure 2G-2	Typical Intersection Approach Signs and Advance Signs for Tourist-Oriented Directional Signs	2G-5
 CHAPTER 2H. RECREATIONAL AND CULTURAL INTEREST AREA SIGNS		
Figure 2H-1	Typical Use of Educational Plaques, Prohibitory Slashes, and Arrows	2H-5
Figure 2H-2	Typical General Directional Guide Signs for Conventional Roads ...	2H-7
Figure 2H-3	Height and Lateral Position of Signs Located Within Recreational and Cultural Interest Areas.....	2H-8
Figure 2H-4	Typical Symbol Signing Layout.....	2H-9
Figure 2H-5	Modifications to Existing Symbols.....	2H-10
Figure 2H-6	New Recreational and Cultural Interest Area Symbols	2H-11
 PART 3. MARKINGS		
 CHAPTER 3B. PAVEMENT AND CURB MARKINGS		
Figure 3B-1	Typical Two-Lane, Two-Way Marking Applications	3B-2
Figure 3B-2	Typical Four-or-More Lane, Two-Way Marking Applications	3B-3
Figure 3B-3	Typical Three-lane, Two-Way Marking Applications	3B-5
Figure 3B-4	Typical Three-Lane, Two-Way Marking for Changing Direction of the Center Lane	3B-7
Figure 3B-5	Method of Locating and Determining the Limits of No-Passing Zones at Curves.....	3B-10
Figure 3B-6	Typical Reversible Lane Marking Application	3B-12
Figure 3B-7	Typical Two-Way Left-Turn Lane Marking Applications.....	3B-13
Figure 3B-8	Typical Exit Ramp and Cloverleaf Ramp Markings	3B-16

MANUAL ON UNIFORM TRAFFIC CONTROL DEVICES

LIST OF FIGURES

		<u>Page</u>
Figure 3B-9	Typical Entrance Ramp Markings	3B-18
Figure 3B-10	Typical Lane Drop Markings at Exit Ramps.....	3B-20
Figure 3B-11	Typical Pavement Marking Applications	3B-23
Figure 3B-12	Typical Lane Reduction Transition Markings	3B-25
Figure 3B-13	Typical Markings for Obstructions in the Roadway	3B-28
Figure 3B-14	Typical Yield Line Layout for Streets and Highways	3B-33
Figure 3B-15	Typical Types of Crosswalk Markings	3B-36
Figure 3B-16	Typical Crosswalk Markings for Exclusive Pedestrian Phase that Permits Diagonal Crossing	3B-36
Figure 3B-17	Typical Parking Space Markings.....	3B-38
Figure 3B-18	International Symbol of Accessibility Parking Space Marking with Blue Background and White Border Options	3B-39
Figure 3B-19	Typical Elongated Letters for Word Pavement Markings	3B-39
Figure 3B-20	Typical Lane-Use, Lane Reduction, and Wrong-Way Arrows for Pavement Markings	3B-40
Figure 3B-21	Typical Lane Use Control Word and Symbol Markings	3B-43
Figure 3B-22	Typical Arrow Markings at Exit-Ramp Terminals to Deter Wrong-Way Entry.....	3B-44
Figure 3B-23	Typical Arrow Markings at Entrance Ramp Terminals Where Design Does Not Clearly Indicate the Direction of Flow.....	3B-45
Figure 3B-24	Typical Yield Ahead Triangle Symbols for Streets and Highways...	3B-46
Figure 3B-25	Typical Markings for Preferential Lanes for Motorized Vehicles.....	3B-53
Figure 3B-26	Typical Markings for Roundabouts with One Lane.....	3B-57
Figure 3B-27	Typical Markings for Roundabouts with Two Lanes	3B-58
Figure 3B-28	Typical Pavement Markings for Speed Humps.....	3B-60
Figure 3B-29	Typical Pavement Markings for Speed Tables or Speed Humps with Crosswalks	3B-61
Figure 3B-30	Typical Advance Warning Markings for Speed Humps.....	3B-62

CHAPTER 3D. DELINEATORS

Figure 3D-1	Typical Delineator Installation	3D-5
-------------	---------------------------------------	------

PART 4. HIGHWAY TRAFFIC SIGNALS

CHAPTER 4C. TRAFFIC CONTROL SIGNAL NEEDS STUDIES

Figure 4C-1	Warrant 2 - Four-Hour Vehicular Volume	4C-7
Figure 4C-2	Warrant 2 - Four-Hour Vehicular Volume (70% Factor).....	4C-7
Figure 4C-3	Warrant 3 - Peak Hour.....	4C-9
Figure 4C-4	Warrant 3 - Peak Hour (70% Factor)	4C-9

MANUAL ON UNIFORM TRAFFIC CONTROL DEVICES

LIST OF FIGURES

		<u>Page</u>
CHAPTER 4D. TRAFFIC CONTROL SIGNAL FEATURES		
Figure 4D-1	Maximum Mounting Height of Signal Faces Located Between 12 m (40 ft) and 16 m (53 ft) from Stop Line	4D-25
Figure 4D-2	Horizontal Location of Signal Faces.....	4D-26
Figure 4D-3	Typical Arrangements of Signal Lenses in Signal Faces.....	4D-31
CHAPTER 4E. PEDESTRIAN CONTROL FEATURES		
Figure 4E-1	Typical Pedestrian Signal Indications.....	4E-4
Figure 4E-2	Recommended Pushbutton Locations for Accessible Pedestrian Signals.....	4E-11
CHAPTER 4J. LANE-USE CONTROL SIGNALS		
Figure 4J-1	Left-Turn Lane-Use Control Signals.....	4J-3
 PART 6. TEMPORARY TRAFFIC CONTROL		
CHAPTER 6C. TEMPORARY TRAFFIC CONTROL ELEMENTS		
Figure 6C-1	Component Parts of a Temporary Traffic Control Zone	6C-4
Figure 6C-2	Types of Tapers and Buffer Spaces	6C-8
Figure 6C-3	Example of a One-Lane Two-Way Traffic Taper	6C-12
CHAPTER 6E. FLAGGER CONTROL		
Figure 6E-1	Use of Hand-Signaling Devices by Flaggers.....	6E-4
CHAPTER 6F. TEMPORARY TRAFFIC CONTROL ZONE DEVICES		
Figure 6F-1	Height and Lateral Location of Signs - Typical Installations.....	6F-4
Figure 6F-2	Methods of Mounting Signs Other Than on Posts	6F-6
Figure 6F-3	Advance Warning Arrow Display Specifications	6F-38
Figure 6F-4	Channelizing Devices	6F-42

MANUAL ON UNIFORM TRAFFIC CONTROL DEVICES

LIST OF FIGURES

		<u>Page</u>
CHAPTER 6H. TYPICAL APPLICATIONS		
Figure 6H-1	Work Beyond the Shoulder (TA-1)	6H-7
Figure 6H-2	Blasting Zone (TA-2)	6H-9
Figure 6H-3	Work on Shoulders (TA-3)	6H-11
Figure 6H-4	Short Duration or Mobile Operation on Shoulder (TA-4)	6H-13
Figure 6H-5	Shoulder Closure on Freeway (TA-5)	6H-15
Figure 6H-6	Shoulder Work with Minor Encroachment (TA-6)	6H-17
Figure 6H-7	Road Closure with Diversion (TA-7)	6H-19
Figure 6H-8	Road Closure with Off-Site Detour (TA-8)	6H-21
Figure 6H-9	Overlapping Routes with Detour (TA-9)	6H-23
Figure 6H-10	Lane Closure on Two-Lane Road Using Flaggers (TA-10)	6H-25
Figure 6H-11	Lane Closure on Two-Volume Two-Lane Road (TA-11)	6H-27
Figure 6H-12	Lane Closure on Two-Lane Road Using Traffic Control Signals (TA-12)	6H-29
Figure 6H-13	Temporary Road Closure (TA-13)	6H-31
Figure 6H-14	Haul Road Crossing (TA-14)	6H-33
Figure 6H-15	Work in Center of Low-Volume Road (TA-15)	6H-35
Figure 6H-16	Surveying Along Centerline of Low-Volume Road (TA-16)	6H-37
Figure 6H-17	Mobile Operations on Two-Lane Road (TA-17)	6H-39
Figure 6H-18	Lane Closure on Minor Street (TA-18)	6H-41
Figure 6H-19	Detour for One Travel Direction (TA-19)	6H-43
Figure 6H-20	Detour for Closed Street (TA-20)	6H-45
Figure 6H-21	Lane Closure on Near Side of Intersection (TA-21)	6H-47
Figure 6H-22	Right Lane Closure on Far Side of Intersection (TA-22)	6H-49
Figure 6H-23	Left Lane Closure on Far Side of Intersection (TA-23)	6H-51
Figure 6H-24	Half Road Closure on Far Side of Intersection (TA-24)	6H-53
Figure 6H-25	Multiple Lane Closures at Intersection (TA-25)	6H-55
Figure 6H-26	Closure in Center of Intersection (TA-26)	6H-57
Figure 6H-27	Closure at Side of Intersection (TA-27)	6H-59
Figure 6H-28	Sidewalk Detour or Diversion (TA-28)	6H-61
Figure 6H-29	Crosswalk Closures and Pedestrian Detours (TA-29)	6H-63
Figure 6H-30	Interior Lane Closure on Multi-Lane Street (TA-30)	6H-65
Figure 6H-31	Lane Closures on Street with Uneven Directional Volumes (TA-31)	6H-67
Figure 6H-32	Half Road Closure on Multi-Lane, High-Speed Highway (TA-32)	6H-69
Figure 6H-33	Stationary Lane Closure on Divided Highway (TA-33)	6H-71
Figure 6H-34	Lane Closure with Temporary Traffic Barrier (TA-34)	6H-73
Figure 6H-35	Mobile Operation on Multi-Lane Road (TA-35)	6H-75
Figure 6H-36	Lane Shift on Freeway (TA-36)	6H-77
Figure 6H-37	Double Lane Closure on Freeway (TA-37)	6H-79
Figure 6H-38	Interior Lane Closure on Freeway (TA-38)	6H-81
Figure 6H-39	Median Crossover on Freeway (TA-39)	6H-83

MANUAL ON UNIFORM TRAFFIC CONTROL DEVICES

LIST OF FIGURES

		<u>Page</u>
Figure 6H-40	Median Crossover for Entrance Ramp (TA-40).....	6H-85
Figure 6H-41	Median Crossover for Exit Ramp (TA-41)	6H-87
Figure 6H-42	Work in Vicinity of Exit Ramp (TA-42)	6H-89
Figure 6H-43	Partial Exit Ramp Closure (TA-43).....	6H-91
Figure 6H-44	Work in Vicinity of Entrance Ramp (TA-44).....	6H-93
Figure 6H-45	Movable Barriers (TA-45).....	6H-95
Figure 6H-46	Work in Vicinity of Highway-Rail Grade-Crossing (TA-46)	6H-97

PART 7. TRAFFIC CONTROLS FOR SCHOOL AREAS

CHAPTER 7A. GENERAL

Figure 7A-1	Typical School Route Plan Map.....	7A-2
-------------	------------------------------------	------

CHAPTER 7B. SIGNS

Figure 7B-1	Typical Signing for School Area Traffic Control.....	7B-6
-------------	--	------

CHAPTER 7C. MARKINGS

Figure 7C-1	Two-Lane Pavement Marking of "SCHOOL"	7C-4
-------------	---	------

PART 8. TRAFFIC CONTROLS FOR HIGHWAY-RAIL GRADE CROSSINGS

CHAPTER 8A. GENERAL

Figure 8A-1	Train Dynamic Envelope Delineation.....	8A-2
-------------	---	------

CHAPTER 8B. SIGNS AND MARKINGS

Figure 8B-1	Highway-Rail Grade Crossing (Crossbuck) Sign	8B-2
Figure 8B-2	Typical Placement of Warning Signs and Pavement Markings at Highway-Rail Grade Crossings	8B-13
Figure 8B-3	Typical Highway-Rail Grade Crossing Pavement Markings	8B-14

MANUAL ON UNIFORM TRAFFIC CONTROL DEVICES

LIST OF FIGURES

		<u>Page</u>
Figure 8B-4	Typical Train Dynamic Envelope Delineation Pavement Markings	8B-16

CHAPTER 8D. FLASHING LIGHT SIGNALS, GATES, AND TRAFFIC CONTROL SIGNALS

Figure 8D-1	Composite Drawing of Active Traffic Control Devices for Highway-Rail Grade Crossings Showing Clearances.....	8D-2
Figure 8D-2	Typical Location Plan for Flashing-Light Signals and Four-Quadrant Gates	8D-7

PART 9. TRAFFIC CONTROLS FOR BICYCLES FACILITIES

CHAPTER 9B. SIGNS

Figure 9B-1	Sign Placement on Shared-Use Paths.....	9B-2
Figure 9B-2	Typical Signing for the Beginning and End of a Bicycle Route	9B-14
Figure 9B-3	Typical Signs and Markings for Shared-Use Paths.....	9B-15

CHAPTER 9C. MARKINGS

Figure 9C-1	Typical Intersection Pavement Markings - Designated Bicycle Lane with Left-Turn Area, Heavy Turn Volumes, Parking, One-Way Traffic, or Divided Highway	9C-2
Figure 9C-2	Centerline Markings for Shared-Use Paths	9C-4
Figure 9C-3	Typical Bicycle Lane Treatment at a Right Turn Only Lane	9C-6
Figure 9C-4	Typical Bicycle Lane Treatment at Parking Lane Into a Right Turn Only Lane	9C-7
Figure 9C-5	Typical Pavement Markings for Bicycle Lanes on a Two-Way Street	9C-8
Figure 9C-6	Typical Optional Word and Symbol Pavement Markings for Bicycle Lanes	9C-9
Figure 9C-7	Typical Obstruction Pavement Marking.....	9C-10

MANUAL ON UNIFORM TRAFFIC CONTROL DEVICES

LIST OF FIGURES

Page

PART 10. TRAFFIC CONTROLS FOR HIGHWAY-LIGHT RAIL TRANSIT GRADE CROSSINGS

CHAPTER 10C. SIGNS, ILLUMINATION, AND MARKINGS

Figure 10C-1	Light Rail Transit Vehicle Dynamic Envelope.....	10C-10
Figure 10C-2	Typical Light Rail Transit Vehicle Dynamic Envelope Delineation Pavement Markings	10C-10
Figure 10C-3	Typical Light Rail Transit Car Dynamic Envelope Delineation Pavement Markings	10C-12
Figure 10C-4	Typical Light Rail Transit Vehicle Dynamic Envelope Delineation Contrasting Pavement Texture.....	10C-12

CHAPTER 10D. HIGHWAY-LIGHT RAIL TRANSIT ACTIVE TRAFFIC CONTROL GRADE CROSSING SYSTEMS

Figure 10D-1	Typical Light Rail Transit Signals.....	10D-8
Figure 10D-2	Typical Light Rail Transit Flashing-Light Signal Assembly for Pedestrian Crossings.....	10D-10
Figure 10D-3	Typical Pedestrian Gate Placement Behind the Sidewalk.....	10D-11
Figure 10D-4	Typical Pedestrian Gate Placement with Pedestrian Gate Arm	10D-11
Figure 10D-5	Typical Placement of Pedestrian Traffic Gates	10D-12
Figure 10D-6	Typical Swing Gates.....	10D-13
Figure 10D-7	Typical Pedestrian Barriers at an Offset Highway - Light Rail Transit Crossing.....	10D-13
Figure 10D-8	Typical Examples of Pedestrian Barrier Installation at an Offset Non-Intersection Light Rail Transit Crossing	10D-14

MANUAL ON UNIFORM TRAFFIC CONTROL DEVICES

LIST OF TABLES

Page

INTRODUCTION

Table I-1	Evolution of the MUTCD	I-2
-----------	------------------------------	-----

PART 1. GENERAL

CHAPTER 1A. GENERAL

Table 1A-1	Acceptable Abbreviations	1A-24
Table 1A-2	Abbreviations That Are Acceptable Only With a Prompt Word	1A-25
Table 1A-3	Unacceptable Abbreviations	1A-26

PART 2. SIGNS

CHAPTER 2A. GENERAL

Table 2A-1	Illumination of Sign Elements	2A-6
Table 2A-2	Retroreflection of Sign Elements	2A-6
Table 2A-3	Use of Sign Shapes	2A-7
Table 2A-4	Common Uses of Sign Colors	2A-9

CHAPTER 2B. REGULATORY SIGNS

Table 2B-1	Regulatory Sign Sizes	2B-2
Table 2B-2	Meanings of Symbols and Legends on Reversible Lane Control Signs	2B-26

CHAPTER 2C. WARNING SIGNS

Table 2C-1	Application of Warning Signs	2C-2
Table 2C-2	Warning Sign Sizes	2C-4
Table 2C-3	Minimum Size of Supplemental Warning Plaques	2C-5
Table 2C-4	Guidelines for Advance Placement of Warning Signs	2C-6
Table 2C-5	Horizontal Alignment Sign Usage	2C-10

MANUAL ON UNIFORM TRAFFIC CONTROL DEVICES

LIST OF TABLES

		<u>Page</u>
CHAPTER 2E. GUIDE SIGNS - FREEWAYS AND EXPRESSWAYS		
Table 2E-1	Minimum Letter and Numeral Sizes for Expressway Guide Signs According to Interchange Classification	2E-10
Table 2E-2	Minimum Letter and Numeral Sizes for Expressway Guide Signs According to Sign Type	2E-12
Table 2E-3	Minimum Letter and Numeral Sizes for Freeway Guide Signs According to Interchange Classification	2E-14
Table 2E-4	Minimum Letter and Numeral Sizes for Freeway Guide Signs According to Sign Type	2E-16
 CHAPTER 2H. RECREATIONAL AND CULTURAL INTEREST AREA SIGNS		
Table 2H-1	Category Chart for Symbols.....	2H-3
 PART 3. MARKINGS		
CHAPTER 3B. PAVEMENT AND CURB MARKINGS		
Table 3B-1	Minimum Passing Sight Distances.....	3B-9
Table 3B-2	Standard Edge Line Lane Markings for Preferential Lanes.....	3B-52
 CHAPTER 3D. DELINEATORS		
Table 3D-1	Approximate Spacing for Delineators on Horizontal Curves	3D-6
 PART 4. HIGHWAY TRAFFIC SIGNALS		
CHAPTER 4C. TRAFFIC CONTROL SIGNAL NEEDS STUDIES		
Table 4C-1	Warrant 1, Eight-Hour Vehicular Volume	4C-5
 CHAPTER 4D. TRAFFIC CONTROL SIGNAL FEATURES		
Table 4D-1	Minimum Sight Distance	4D-23

MANUAL ON UNIFORM TRAFFIC CONTROL DEVICES

LIST OF TABLES

Page

PART 5. TRAFFIC CONTROL DEVICES FOR LOW-VOLUME ROADS

CHAPTER 5A. GENERAL

Table 5A-1	Minimum Sign Sizes on Low-Volume Roads.....	5A-3
------------	---	------

PART 6. TEMPORARY TRAFFIC CONTROLS

CHAPTER 6C. TRAFFIC CONTROL PLANS

Table 6C-1	Suggested Advance Warning Sign Spacing.....	6C-5
Table 6C-2	Taper Length Criteria for Temporary Traffic Control Zones	6C-10

CHAPTER 6E. FLAGGER CONTROL

Table 6E-1	Distance of Flagger Station in Advance of the Work Space	6E-6
------------	--	------

CHAPTER 6H. TYPICAL APPLICATIONS

Table 6H-1	Index to Typical Application Diagrams	6H-2
Table 6H-2	Meaning of Symbols on Typical Application Diagrams.....	6H-4
Table 6H-3	Meaning of Letter Codes on Typical Application Diagrams	6H-5

PART 7. TRAFFIC CONTROLS FOR BICYCLE FACILITIES

CHAPTER 7B. SIGNS

Table 7B-1	Size of School Area Signs and Plaques.....	7B-2
------------	--	------

PART 9. TRAFFIC CONTROLS FOR BICYCLE FACILITIES

CHAPTER 9B. SIGNS

Table 9B-1	Sign Sizes for Shared-Use Paths	9B-3
------------	---------------------------------------	------



PART 1

General

MUTCD 2000

Manual on Uniform Traffic Control Devices

m i l l e n n i u m e d i t i o n

December 2000



U.S. Department
of Transportation

**Federal Highway
Administration**

PART 1. GENERAL

TABLE OF CONTENTS

	<u>Page</u>
CHAPTER 1A. GENERAL	Dec., 2000
Section 1A.01 Purpose of Traffic Control Devices.....	1A-1
Section 1A.02 Principles of Traffic Control Devices	1A-1
Section 1A.03 Design of Traffic Control Devices	1A-2
Section 1A.04 Placement and Operation of Traffic Control Devices.....	1A-3
Section 1A.05 Maintenance of Traffic Control Devices.....	1A-3
Section 1A.06 Uniformity of Traffic Control Devices	1A-4
Section 1A.07 Responsibility for Traffic Control Devices	1A-4
Section 1A.08 Authority for Placement of Traffic Control Devices	1A-5
Section 1A.09 Engineering Study and Engineering Judgment.....	1A-6
Section 1A.10 Interpretations, Experimentations, and Changes.....	1A-6
Section 1A.11 Relation to Other Documents.....	1A-10
Section 1A.12 Color Code	1A-12
Section 1A.13 Definitions of Words and Phrases in this Manual.....	1A-13
Section 1A.14 Abbreviations Used on Traffic Control Devices.....	1A-23

FIGURES

CHAPTER 1A. GENERAL	
Figure 1A-1 Typical Process for Requesting and Conducting Experimentations for New Traffic Control Devices.....	1A-8
Figure 1A-2 Typical Process for Incorporating New Traffic Control Devices into the MUTCD	1A-11

TABLES

CHAPTER 1A. GENERAL	
Table 1A-1 Acceptable Abbreviations.....	1A-24
Table 1A-2 Abbreviations That Are Acceptable Only With a Prompt Word.....	1A-25
Table 1A-3 Unacceptable Abbreviations.....	1A-26

CHAPTER 1A. GENERAL

Section 1A.01 Purpose of Traffic Control Devices

Support:

The purpose of traffic control devices, as well as the principles for their use, is to promote highway safety and efficiency by providing for the orderly movement of all road users on streets and highways throughout the nation.

Traffic control devices notify road users of regulations and provide warning and guidance needed for the safe, uniform, and efficient operation of all elements of the traffic stream.

Standard:

Traffic control devices or their supports shall not bear any advertising message or any other message that is not related to traffic control.

Support:

Tourist-oriented directional signs and Specific Service signs are not considered advertising; rather, they are classified as motorist service signs.

Section 1A.02 Principles of Traffic Control Devices

Support:

This Manual contains the basic principles that govern the design and use of traffic control devices for all streets and highways open to public travel regardless of type or class or the public agency having jurisdiction. This Manual's text specifies the restriction on the use of a device if it is intended for limited application or for a specific system. It is important that these principles be given primary consideration in the selection and application of each device.

Guidance:

To be effective, a traffic control device should meet five basic requirements:

- A. Fulfill a need,
- B. Command attention,
- C. Convey a clear, simple meaning,
- D. Command respect from road users, and
- E. Give adequate time for proper response.

The following aspects of traffic control devices should be considered to ensure that the above criteria are met: design; placement and operation; maintenance; and uniformity. Vehicle speed should be carefully considered as an element that governs the design, operation, placement, and location of various traffic control devices.

Support:

The definition of the word speed varies depending on its use. The definitions of specific speed terms are contained in Section 1A.13.

Guidance:

The actions required of road users to obey regulatory devices should be specified by State statute, or in cases not covered by State statute, by local ordinance or resolution consistent with the "Uniform Vehicle Code."

The proper use of traffic control devices should provide the reasonable and prudent road user with the information necessary to safely and lawfully use the streets, highways, pedestrian facilities, and bikeways.

Support:

Uniformity of the meaning of traffic control devices is vital to their effectiveness. The meanings ascribed to devices in this Manual are in general accord with the documents mentioned in Section 1A.11.

Section 1A.03 Design of Traffic Control Devices

Guidance:

Devices should be designed so that features such as size, shape, and color, composition, lighting or retroreflection, and contrast are combined to draw attention to the devices; that size, shape, color, and simplicity of message combine to produce a clear meaning; that legibility and size combine with placement to permit adequate time for response; and that uniformity, size, legibility, and reasonableness of the message combine to command respect.

Standard:

All adopted symbol signs are shown in the "Standard Highway Signs" book (see Section 1A.11). All symbols and colors for signs not shown in the "Standard Highway Signs" book shall follow the procedures for experimentation and change described in Section 1A.10. All symbols shall be unmistakably similar to or mirror images of those shown herein. Symbols and colors shall not be modified unless otherwise stated herein.

Guidance:

Aspects of a device's design should be modified only if there is demonstrated need.

Support:

An example of modifying a device's design would be to modify the Side Road (W2-2) sign to show a second offset intersecting road.

Option:

Highway agencies may develop word message signs to notify road users of special regulations or to warn road users of a situation that may not be readily apparent. Unlike with symbol signs and colors, new word message signs may be used without the need for experimentation. With the exception of symbols and colors, minor modifications in the specific design elements of a device may be made provided the essential appearance characteristics are preserved. Although the standard design of symbol signs cannot be modified, it may be appropriate to change the orientation of the symbol to better reflect the direction of travel.

Section 1A.04 Placement and Operation of Traffic Control Devices**Guidance:**

Placement of a traffic control device should be within the road user's view so that maximum visual acuity is provided. To aid in conveying the proper meaning, the traffic control device should be appropriately positioned with respect to the location, object, or situation to which it applies. The location and legibility of the traffic control device should be such that a road user has adequate time to make the proper response in both day and night conditions.

Traffic control devices should be placed and operated in a uniform and consistent manner.

Unnecessary traffic control devices should be removed. The fact that a device is in good physical condition should not be a basis for deferring needed removal or change.

Section 1A.05 Maintenance of Traffic Control Devices**Guidance:**

Traffic control devices should be reviewed periodically to determine if they meet current traffic conditions.

Traffic control devices should be maintained to ensure that legibility is retained, that the device is visible, and that it functions properly in relation to other traffic control devices in the vicinity during both day and night conditions.

Support:

Clean, legible, properly mounted devices in good working condition command the respect of road users.

Section 1A.06 Uniformity of Traffic Control Devices

Support:

Uniformity of devices simplifies the task of the road user because it aids in recognition and understanding, thereby reducing perception/reaction time. Uniformity assists road users, police officers, and traffic courts by giving everyone the same interpretation. Uniformity assists public highway officials through efficiency in manufacture, installation, maintenance, and administration. Uniformity means treating similar situations in a similar way. The use of uniform traffic control devices does not, in itself, constitute uniformity. A standard device used where it is not appropriate is as objectionable as a nonstandard device; in fact, this might be worse, because such misuse might result in disrespect at those locations where the device is needed and appropriate.

Section 1A.07 Responsibility for Traffic Control Devices

Standard:

The responsibility for the design, placement, operation, maintenance, and uniformity of traffic control devices shall rest with the public agency or the official having jurisdiction. 23 CFR 655.603 adopts the Manual on Uniform Traffic Control Devices as the national standard for all traffic control devices installed on any street, highway, or bikeway open to public travel. When a State or other Federal agency manual or supplement is required, they shall be in substantial conformance with the national Manual on Uniform Traffic Control Devices.

23 CFR 655.603 also states that traffic control devices on all streets and highways open to public travel in each State shall be in substantial conformance with standards issued or endorsed by the Federal Highway Administrator.

Support:

The "Uniform Vehicle Code" (see Section 1A.11) has the following provision in Section 15-104 for the adoption of a uniform Manual:

"(a)The [State Highway Agency] shall adopt a manual and specification for a uniform system of traffic control devices consistent with the provisions of this code for use upon

highways within this State. Such uniform system shall correlate with and so far as possible conform to the system set forth in the most recent edition of the Manual on Uniform Traffic Control Devices for Streets and Highways, and other standards issued or endorsed by the Federal Highway Administrator."

"(b) The Manual adopted pursuant to subsection (a) shall have the force and effect of law."

Additionally, States are encouraged to adopt Section 15-117 of the "Uniform Vehicle Code," which states that, "No person shall install or maintain in any area of private property used by the public any sign, signal, marking or other device intended to regulate, warn, or guide traffic unless it conforms with the State manual and specifications adopted under Section 15-104."

Section 1A.08 Authority for Placement of Traffic Control Devices

Standard:

Traffic control devices, advertisements, announcements, and other signs or messages within the highway right-of-way shall be placed only as authorized by a public authority or the official having jurisdiction, for the purpose of regulating, warning, or guiding traffic.

When the public agency or the official having jurisdiction over a street or highway has granted proper authority, others such as contractors and public utility companies shall be permitted to install temporary traffic control devices in temporary traffic control zones. Such traffic control devices shall conform with the Standards of this Manual.

Guidance:

Any unauthorized traffic control device or other sign or message placed on the highway right-of-way by a private organization or individual constitutes a public nuisance and should be removed. All unofficial or non-essential traffic control devices, or other signs or messages should be removed.

Standard:

All regulatory traffic control devices shall be supported by laws, ordinances, or regulations.

Support:

Provisions of this Manual are based upon the concept that effective traffic control depends upon both appropriate application of the devices and reasonable enforcement of the regulations.

Section 1A.09 Engineering Study and Engineering Judgment

Standard:

This Manual describes the application of traffic control devices, but shall not be a legal requirement for their installation.

Guidance:

The decision to use a particular device at a particular location should be made on the basis of either an engineering study or the application of engineering judgment. Thus, while this Manual provides Standards, Guidance, and Options for design and application of traffic control devices, this Manual should not be considered a substitute for engineering judgment.

Engineering judgment should be exercised in the selection and application of traffic control devices, as well as in the location and design of the roads and streets that the devices complement. Jurisdictions with responsibility for traffic control that do not have engineers on their staffs, should seek engineering assistance from others, such as the State transportation agency, their county, a nearby large city, or a traffic engineering consultant.

Section 1A.10 Interpretations, Experimentations, and Changes

Standard:

Design, application, and placement of traffic control devices other than those adopted in this Manual shall be prohibited unless the provisions of this Section are followed.

Support:

Continuing advances in technology will produce changes in the highway, the vehicle, and in road user proficiency; therefore, portions of the system of traffic control devices in this Manual will require updating. In addition, unique situations often arise for device applications that might require interpretation or clarification of this Manual. It is important to have a procedure for recognizing these developments and for introducing new ideas and modifications into the system.

Guidance:

Requests for any interpretation, permission to experiment, or change should be sent to the Federal Highway Administration (FHWA), Office of Transportation Operations, 400 Seventh Street SW, HOTO, Washington, DC 20590.

Support:

An interpretation includes a consideration of the application and operation of standard traffic control devices, official meanings of standard traffic control devices, or the variations from standard device designs.

Guidance:

Requests for an interpretation of this Manual should contain the following information:

- A. A concise statement of the interpretation being sought.
- B. A description of the condition that provoked the need for a revised interpretation.
- C. Any illustration that would be helpful to understand the request.
- D. Any supporting research data that is pertinent to the item to be interpreted.

Support:

Requests to experiment include consideration of testing or evaluating a new traffic control device, its application or manner of use, or a provision not specifically described in this Manual.

A request for permission to experiment will be considered only when submitted by the public agency or private toll facility responsible for the operation of the road or street on which the experiment is to take place.

A diagram indicating the process for experimenting with traffic control devices is shown in Figure 1A-1.

Guidance:

The request for permission to experiment should contain the following:

- A. A statement indicating the nature of the problem.
- B. A description of the proposed change to the traffic control device or application of the traffic control device, how it was developed, the manner in which it deviates from the standard, and how it is expected to be an improvement over existing standards.
- C. Any illustration that would be helpful to understand the traffic control device or use of the traffic control device.

Figure 1A-1. Typical Process for Requesting and Conducting Experimentations for New Traffic Control Devices

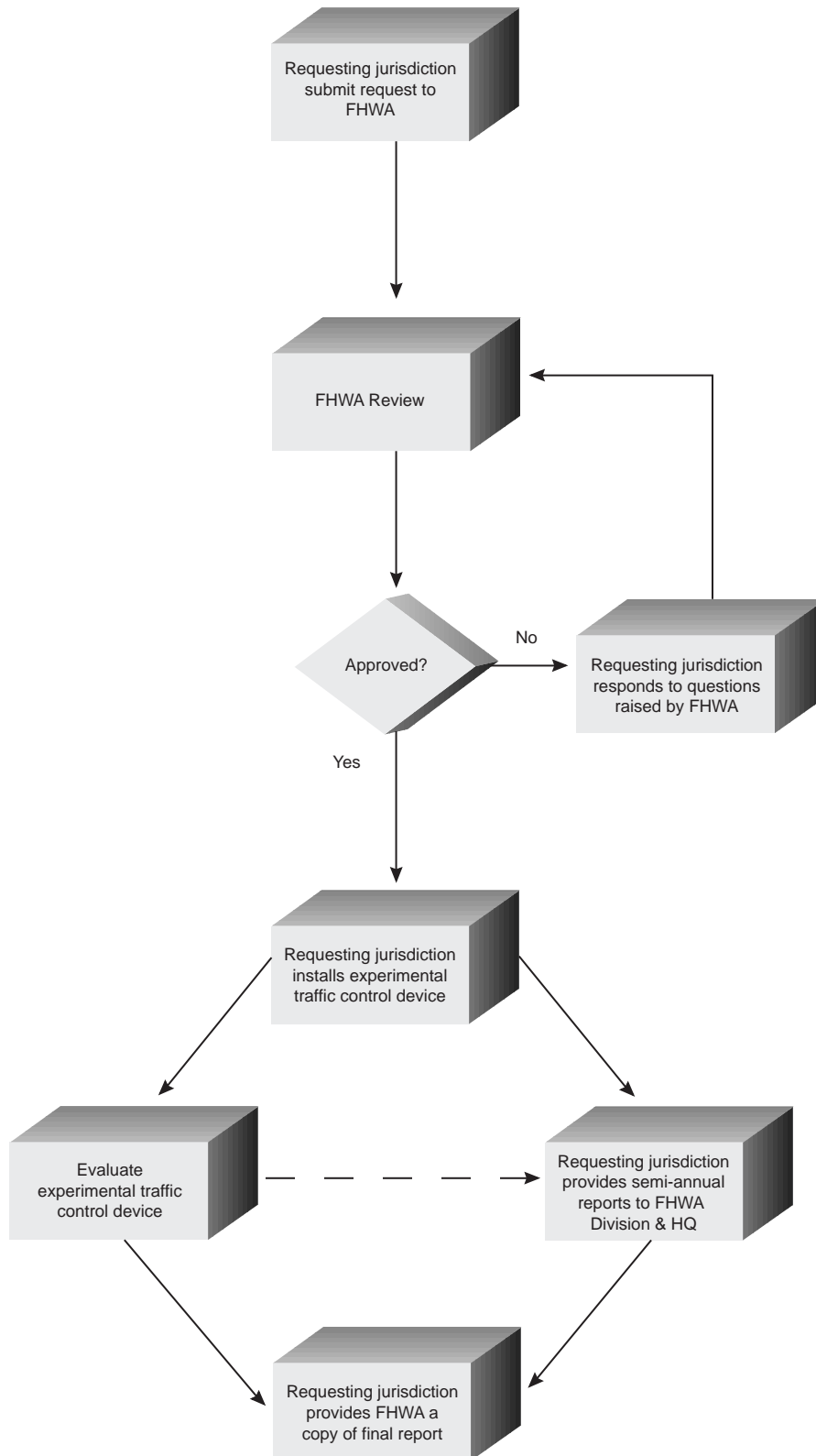

- D. Any supporting data explaining how the traffic control device was developed, if it has been tried, in what ways it was found to be adequate or inadequate, and how this choice of device or application was derived.
- E. A legally-binding statement certifying that the traffic control device is not protected by a patent or copyright.
- F. The time period and location(s) of the experiment.
- G. A detailed research or evaluation plan that must provide for close monitoring of the experimentation, especially in the early stages of its field implementation. The evaluation plan should include before and after studies as well as quantitative data describing the performance of the experimental device.
- H. An agreement to restore the site of the experiment to a condition that complies with the provisions of this Manual within 3 months following the end of the time period of the experiment. This agreement must also provide that the agency sponsoring the experimentation will terminate the experimentation at any time that it determines significant safety concerns are directly or indirectly attributable to the experimentation. The FHWA's Office of Transportation Operations has the right to terminate approval of the experimentation at any time if there is an indication of safety concerns. If, as a result of the experimentation, a request is made that this Manual be changed to include the device or application being experimented with, the device or application will be permitted to remain in place until an official rulemaking action has occurred.
- I. An agreement to provide semiannual progress reports for the duration of the experimentation, and an agreement to provide a copy of the final results of the experimentation to the FHWA's Office of Transportation Operations within 3 months following completion of the experimentation. The FHWA's Office of Transportation Operations has the right to terminate approval of the experimentation if reports are not provided in accordance with this schedule.

Support:

A change includes consideration of a new device to replace a present standard device, an additional device to be added to the list of standard devices, or a revision to a traffic control device application or placement criteria.

Guidance:

Requests for a change to this Manual should contain the following information:

- A. A statement indicating what change is proposed.
- B. Any illustration that would be helpful to understand the request.

C. Any supporting research data that is pertinent to the item to be reviewed.

Support:

A diagram indicating the process for requesting changes to this Manual is shown in Figure 1A-2.

Procedures for revising this Manual are set out in the Federal Register of June 30, 1983 (48 FR 30145).

For additional information concerning interpretations, experimentation, or changes, write to the FHWA, 400 Seventh Street, SW, HOTO, Washington, DC 20590, or visit the MUTCD website at <http://mutcd.fhwa.dot.gov>.

Section 1A.11 Relation to Other Documents

Standard:

To the extent that they are incorporated by specific reference, the latest editions of the following documents, or those editions specifically noted, shall be a part of this Manual: "Standard Alphabets for Highway Signs and Pavement Markings," 1977 Edition (FHWA); "Standard Alphabets for Highway Signs," 1966 Edition (FHWA); "Standard Color Tolerance Limits," (FHWA); and "Standard Highway Signs," 1979 Edition (FHWA).

Support:

For ordering information for the above publications, visit the Federal Highway Administration's MUTCD website at <http://mutcd.fhwa.dot.gov>, or write to the FHWA, 400 Seventh Street, SW, HOTO, Washington, DC 20590.

The latest version of other documents that are useful sources of information with respect to use of this Manual are listed below. See Page i of this Manual for ordering information for the following publications:

- A. "Vehicle Traffic Control Signal Heads," Part 1 - 1985 Edition; Part 2 - 1998 Edition (Institute of Transportation Engineers - ITE)
- B. "Pedestrian Traffic Control Signal Indications," 1985 Edition (ITE)
- C. "Purchase Specification for Flashing and Steady Burn Warning Lights," 1981 Edition (ITE)
- D. "Traffic Signal Lamps," 1980 Edition (ITE)
- E. "Uniform Vehicle Code (UVC) and Model Traffic Ordinance," 1992 Edition (National Committee on Uniform Traffic Laws and Ordinances)

Figure 1A-2. Typical Process for Incorporating New Traffic Control Devices into the MUTCD

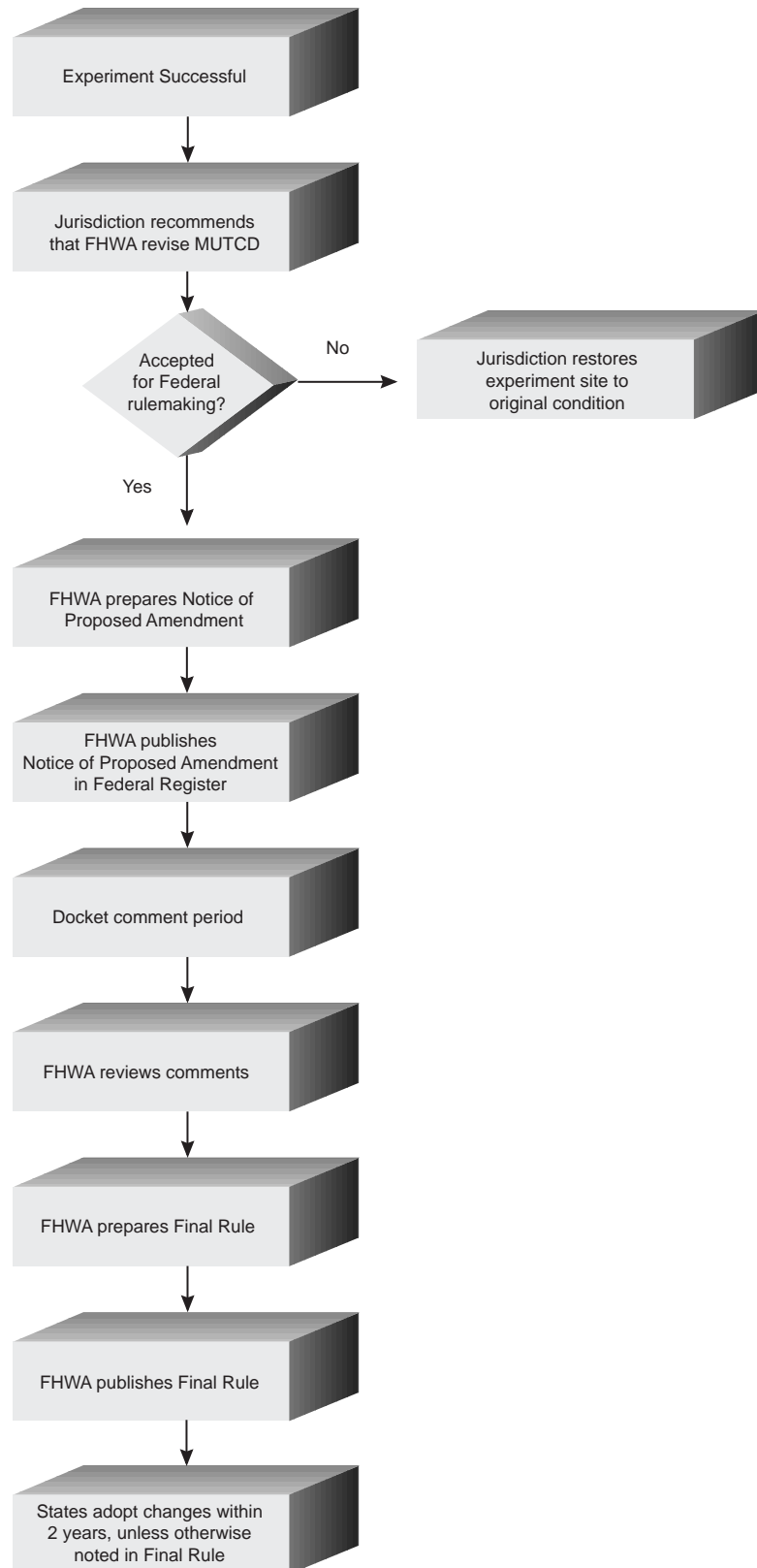

- F. "Traffic Engineering Handbook," 1999 Edition (ITE)
- G. "Highway Capacity Manual," 1998 Edition (Transportation Research Board - TRB)
- H. "A Policy on Geometric Design of Highway and Streets," 1994 Edition (American Association of State Highway and Transportation Officials - AASHTO)
- I. "Guidelines for the Selection of Supplemental Guide Signs for Traffic Generators Adjacent to Freeways," 1993 Edition (AASHTO)
- J. "List of Control Cities for Use in Guide Signs on Interstate Highways," 1993 Edition (AASHTO)
- K. "Manual of Transportation Engineering Studies," 1994 Edition (ITE)
- L. "Roadside Design Guide," 1996 Edition (AASHTO)
- M. "School Trip Safety Program Guidelines," 1984 Edition (ITE)
- N. "Manual of Traffic Signal Design," 1991 Edition (ITE)
- O. "Traffic Detector Handbook," 1991 Edition (ITE)
- P. "2000 AREMA Communications & Signals Manual," American Railway Engineering & Maintenance-of-Way Association (AREMA)
- Q. "Preemption of Traffic Signals at or Near Railroad Grade Crossings with Active Warning Devices," (ITE)
- R. "Highway-Rail Intersection Architecture," U.S. Department of Transportation, Federal Railroad Administration (USDOT/FRA)
- S. "Practice for Roadway Lighting," RP-8, 1983, Illuminating Engineering Society (IES)
- T. "Safety Guide for the Prevention of Radio Frequency Radiation Hazards in the Use of Commercial Electric Detonators (Blasting Caps)," Safety Library Publication No. 20, Institute of Makers of Explosives

Section 1A.12 Color Code

Support:

The following color code establishes general meanings for nine colors of a total of twelve colors that have been identified as being appropriate for use in conveying traffic control information. Central values and tolerance limits for each color are available from the Federal Highway Administration, 400 Seventh Street, SW, HOTO, Washington, DC 20590, and at FHWA's MUTCD website at <http://mutcd.fhwa.dot.gov>.

The three colors for which general meanings have not yet been assigned are being reserved for future applications that will be determined only by FHWA after consultation with the States, the engineering community, and the general public. The meanings described in this Section are of a general nature. More specific assignments of colors are given in the individual Parts of this Manual relating to each class of devices.

Standard:

The general meaning of the 12 colors shall be as follows:

- A. Yellow - warning**
- B. Red - stop or prohibition**
- C. Blue - road user services guidance, tourist information, and evacuation route**
- D. Green - indicated movements permitted, direction guidance**
- E. Brown - recreational and cultural interest area guidance**
- F. Orange - temporary traffic control**
- G. Black - regulation**
- H. White - regulation**
- I. Fluorescent Yellow-Green - pedestrian warning, bicycle warning, school bus and school warning**
- J. Purple - unassigned**
- K. Light Blue - unassigned**
- L. Coral - unassigned**

Section 1A.13 Definitions of Words and Phrases in this Manual

Standard:

Unless otherwise defined herein, or in the other Parts of this Manual, definitions contained in the most recent edition of the "Uniform Vehicle Code," "AASHTO Transportation Glossary (Highway Definitions)," and other documents specified in Section 1A.11 are also incorporated and adopted by reference.

The following words and phrases, when used in this Manual, shall have the following meanings:

- 1. Active Grade Crossing Warning System - the flashing-light signals, with or without warning gates, together with the necessary control equipment used to inform road users of the approach or presence of trains at highway-rail grade crossings.**
- 2. Approach - all lanes of traffic moving towards an intersection or a mid-block location from one direction, including any adjacent parking lane(s).**
- 3. Arterial Highway (Street) - a general term denoting a highway primarily used by through traffic, usually on a continuous route or a highway designated as part of an arterial system.**
- 4. Average Day - a day representing traffic volumes normally and repeatedly found at a location, typically a weekday when volumes are influenced by employment or a weekend when volumes are influenced by entertainment or recreation.**
- 5. Beacon - a highway traffic signal with one or more signal sections that operates in a flashing mode.**
- 6. Bicycle - a pedal-powered vehicle upon which the human operator sits.**
- 7. Bicycle Lane - a portion of a roadway that has been designated by signs and pavement markings for preferential or exclusive use by bicyclists.**
- 8. Centerline Markings - the yellow pavement marking line(s) that delineates the separation of traffic lanes that have opposite directions of travel on a roadway. These markings need not be at the geometrical center of the pavement.**
- 9. Changeable Message Signs - signs that are capable of displaying more than one message, changeable manually, by remote control, or by automatic control. These signs are referred to as Dynamic Message Signs in the National Intelligent Transportation Systems (ITS) Architecture.**
- 10. Channelizing Line Marking - a wide or double solid white line used to form islands where traffic in the same direction of travel is permitted on both sides of the island.**
- 11. Circular Intersection - an intersection that has an island, generally circular in design, located in the center of the intersection where traffic passes to the**

right of the island. Circular intersections include roundabouts, rotaries, and traffic circles.

- 12. Clear Zone - the total roadside border area, starting at the edge of the traveled way, that is wide enough to allow an errant driver to stop or regain control of a vehicle. This area might consist of a shoulder, a recoverable slope, and/or a non-recoverable, traversable slope with a clear run-out area at its toe.**
- 13. Concurrent Flow HOV Lane - an HOV lane that is operated in the same direction as the adjacent mixed flow lanes, separated from the adjacent general purpose freeway lanes by a standard lane stripe, painted buffer, or barrier.**
- 14. Contraflow Lane - a lane operating in a direction opposite to the normal flow of traffic designated for peak direction of travel during at least a portion of the day. Contraflow lanes are usually separated from the off-peak direction lanes by plastic pylons, or by moveable or permanent barrier.**
- 15. Conventional Road - a street or highway other than a low-volume road (as defined in Section 5A.01), expressway, or freeway.**
- 16. Collector Highway - a term denoting a highway that in rural areas connects small towns and local highways to arterial highways, and in urban areas provides land access and traffic circulation within residential, commercial and business areas and connects local highways to the arterial highways.**
- 17. Crosswalk - (a) that part of a roadway at an intersection included within the connections of the lateral lines of the sidewalks on opposite sides of the highway measured from the curbs or in the absence of curbs, from the edges of the traversable roadway, and in the absence of a sidewalk on one side of the roadway, the part of a roadway included within the extension of the lateral lines of the sidewalk at right angles to the centerline; (b) any portion of a roadway at an intersection or elsewhere distinctly indicated for pedestrian crossing by lines or other markings on the surface.**
- 18. Crosswalk Lines - white pavement marking lines that identify a crosswalk.**
- 19. Delineators - retroreflective devices mounted on the roadway surface or at the side of the roadway in a series to indicate the alignment of the roadway, especially at night or in adverse weather.**
- 20. Dynamic Envelope - the clearance required for the train and its cargo overhang due to any combination of loading, lateral motion, or suspension failure.**

- 21. Edge Line Markings - white or yellow pavement marking lines that delineate the right or left edge(s) of a traveled way.**
- 22. End-of-Roadway Marker - a device used to warn and alert road users of the end of a roadway in other than temporary traffic control zones.**
- 23. Engineering Judgment - the evaluation of available pertinent information, and the application of appropriate principles, Standards, Guidance, and practices as contained in this Manual and other sources, for the purpose of deciding upon the applicability, design, operation, or installation of a traffic control device. Engineering judgment shall be exercised by an engineer, or by an individual working under the supervision of an engineer, through the application of procedures and criteria established by the engineer. Documentation of engineering judgment is not required.**
- 24. Engineering Study - the comprehensive analysis and evaluation of available pertinent information, and the application of appropriate principles, Standards, Guidance, and practices as contained in this Manual and other sources, for the purpose of deciding upon the applicability, design, operation, or installation of a traffic control device. An engineering study shall be performed by an engineer, or by an individual working under the supervision of an engineer, through the application of procedures and criteria established by the engineer. An engineering study shall be documented.**
- 25. Expressway - a divided highway with partial control of access.**
- 26. Flashing (Flashing Mode) - a mode of operation in which a traffic signal indication is turned on and off repetitively.**
- 27. Freeway - a divided highway with full control of access.**
- 28. Guide Signs - a sign that shows route designations, destinations, directions, distances, services, points of interest, or other geographical, recreational, or cultural information.**
- 29. High Occupancy Vehicle (HOV) - a motor vehicle carrying at least two or more persons, including carpools, vanpools, and buses.**
- 30. Highway - a general term for denoting a public way for purposes of travel by vehicular travel, including the entire area within the right-of-way.**
- 31. Highway-Rail Grade Crossing - the general area where a highway and a railroad's right-of-way cross at the same level, within which are included the**

railroad tracks, highway, and traffic control devices for highway traffic traversing that area.

- 32. Highway Traffic Signal - a power-operated traffic control device by which traffic is warned or directed to take some specific action. These devices do not include power-operated signs, illuminated pavement markers, barricade warning lights, or steady burning electric lamps.**
- 33. HOV Lane - any preferential lane designated for exclusive use by high-occupancy vehicles for all or part of a day--including a designated lane on a freeway, other highway, street, or independent roadway on a separate right-of-way.**
- 34. Interchange - a system of interconnecting roadways providing for traffic movement between two or more highways that do not intersect at grade.**
- 35. Intermediate Interchange - an interchange with an urban or rural route that is not a major or minor interchange as defined herein.**
- 36. Intersection - (a) the area embraced within the prolongation or connection of the lateral curb lines, or if none, the lateral boundary lines of the roadways of two highways that join one another at, or approximately at, right angles, or the area within which vehicles traveling on different highways that join at any other angle may come into conflict; (b) the junction of an alley or driveway with a roadway or highway shall not constitute an intersection.**
- 37. Island - a defined area between traffic lanes for control of vehicular movements or for pedestrian refuge. It includes all end protection and approach treatments. Within an intersection area, a median or an outer separation is considered to be an island.**
- 38. Lane Line Markings - white pavement marking lines that delineate the separation of traffic lanes that have the same direction of travel on a roadway.**
- 39. Lane-Use Control Signal - a signal face displaying indications to permit or prohibit the use of specific lanes of a roadway or to indicate the impending prohibition of such use.**
- 40. Legend - See Sign Legend.**
- 41. Logo - a distinctive emblem, symbol, or trademark that identifies a product or service.**
- 42. Longitudinal Markings - pavement markings that are generally placed**

parallel and adjacent to the flow of traffic such as lane lines, centerlines, edge lines, channelizing lines, and others.

- 43. Major Interchange - an interchange with another freeway or expressway, or an interchange with a high-volume multi-lane highway, principal urban arterial, or major rural route where the interchanging traffic is heavy or includes many road users unfamiliar with the area.**
- 44. Major Street - the street normally carrying the higher volume of vehicular traffic.**
- 45. Median - the area between two roadways of a divided highway measured from edge of traveled way to edge of traveled way. The median excludes turn lanes. The median width might be different between intersections, interchanges, and at opposite approaches of the same intersection.**
- 46. Minor Interchange - an interchange where traffic is local and very light, such as interchanges with land service access roads. Where the sum of the exit volumes is estimated to be lower than 100 vehicles per day in the design year, the interchange is classified as local.**
- 47. Minor Street - the street normally carrying the lower volume of vehicular traffic.**
- 48. Object Markers - devices used to mark obstructions within or adjacent to the roadway.**
- 49. Occupancy Requirement - any restriction that regulates the use of a facility for any period of the day based on a specified number of persons in a vehicle.**
- 50. Occupants - the people driving or riding in a car, truck, bus, or other vehicle.**
- 51. Paved - a bituminous surface treatment, mixed bituminous concrete, or Portland cement concrete roadway surface that has both a structural (weight bearing) and a sealing purpose for the roadway.**
- 52. Pedestrian - a person afoot, in a wheelchair, on skates, or on a skateboard.**
- 53. Platoon - a group of vehicles or pedestrians traveling together as a group, either voluntarily or involuntarily, because of traffic signal controls, geometrics, or other factors.**
- 54. Preferential Lane Marking - white lines formed in a diamond shape.**

- 55. Principal Legend - place names, street names, and route numbers placed on guide signs.**
- 56. Public Road - any road or street under the jurisdiction of and maintained by a public agency and open to public travel.**
- 57. Raised Pavement Marker - a device with a height of at least 10 mm (0.4 in) mounted on or in a road surface and intended to supplement or substitute for pavement markings.**
- 58. Regulatory Signs - a sign that gives notice to road users of traffic laws or regulations.**
- 59. Retroreflectivity - a property of a surface that allows a large portion of the light coming from a point source to be returned directly back to a point near its origin.**
- 60. Right-of-Way [Assignment] - the permitting of vehicles and/or pedestrians to proceed in a lawful manner in preference to other vehicles or pedestrians by the display of sign or signal indications.**
- 61. Road - see Roadway.**
- 62. Roadway - that portion of a highway improved, designed, or ordinarily used for vehicular travel and parking lanes, but exclusive of the sidewalk, berm, or shoulder even though such sidewalk, berm, or shoulder is used by persons riding bicycles or other human-powered vehicles. In the event a highway includes two or more separate roadways, the term roadway as used herein shall refer to any such roadway separately, but not to all such roadways collectively.**
- 63. Roadway Network - a geographical arrangement of intersecting roadways.**
- 64. Road User - a vehicle operator, bicyclist, or pedestrian within the highway, including workers in temporary traffic control zones.**
- 65. Rumble Strip - a series of intermittent, narrow, transverse areas of rough-textured, slightly-raised, or depressed road surface that is installed to alert road users to unusual traffic conditions.**
- 66. Rural Highway - a type of roadway normally characterized by lower volumes, higher speeds, fewer turning conflicts, and less conflict with pedestrians.**
- 67. Shared Roadway - a roadway that is officially designated and marked as a**

bicycle route, but which is open to motor vehicle travel and upon which no bicycle lane is designated.

- 68. Shared-Use Path - a bikeway physically separated from motorized vehicular traffic by an open space or barrier and either within the highway right-of-way or within an independent alignment. Shared-use paths might also be used by pedestrians, skaters, wheelchair users, joggers, and other non-motorized users.**
- 69. Sidewalk - that portion of a street between the curb line, or the lateral line of a roadway, and the adjacent property line or on easements of private property, intended for use by pedestrians.**
- 70. Sign - any traffic control device that is intended to communicate specific information to road users through a word or symbol legend. Signs do not include traffic control signals, pavement markings, delineators, or channelization devices.**
- 71. Sign Assembly - a group of signs, located on the same support(s), that supplement one another in conveying information to road users.**
- 72. Sign Illumination - either internal or external lighting that shows similar color by day or night. Street, highway, or strobe lighting shall not be considered as meeting this definition.**
- 73. Sign Legend - all word messages, logos, and symbol designs that are intended to convey specific meanings.**
- 74. Sign Panel - a separate panel or piece of material containing a word or symbol legend that is affixed to the face of a sign.**
- 75. Speed - speed is defined based on the following classifications:**
 - (a) Advisory Speed - a recommended speed for all vehicles operating on a section of highway and based on the highway design, operating characteristics, and conditions.**
 - (b) Average Speed - the summation of the instantaneous or spot-measured speeds at a specific location of vehicles divided by the number of vehicles observed.**
 - (c) Design Speed - a selected speed used to determine the various geometric design features of a roadway.**

- (d) **85th-Percentile Speed** - The speed at or below which 85 percent of the motorized vehicles travel.
 - (e) **Operating Speed** - a speed at which a typical vehicle or the overall traffic operates. Operating speed may be defined with speed values such as the average, pace, or 85th-percentile speeds.
 - (f) **Pace Speed** - the highest speed within a specific range of speeds that represents more vehicles than in any other like range of speed. The range of speeds typically used is 10 km/h or 10 mph.
 - (g) **Posted Speed** - the speed limit determined by law and shown on Speed Limit signs.
 - (h) **Statutory Speed** - a speed limit established by legislative action that typically is applicable for highways with specified design, functional, jurisdictional and/or location characteristic and is not necessarily shown on Speed Limit signs.
- 76. Speed Limit** - the maximum (or minimum) speed applicable to a section of highway as established by law.
- 77. Speed Measurement Marking** - a white transverse pavement marking placed on the roadway to assist the enforcement of speed regulations.
- 78. Speed Zone** - a section of highway with a speed limit that is established by law but which may be different from a legislatively-specified statutory speed limit.
- 79. Stop Line** - a solid white pavement marking line extending across approach lanes to indicate the point at which a stop is intended or required to be made.
- 80. Street** - see Highway.
- 81. Temporary Traffic Control Zone** - an area of a highway where road user conditions are changed because of a work zone or incident by the use of temporary traffic control devices, flaggers, police, or other authorized personnel.
- 82. Traffic** - pedestrians, bicyclists, ridden or herded animals, vehicles, streetcars, and other conveyances either singularly or together while using any highway for purposes of travel.
- 83. Traffic Control Devices** - all signs, signals, markings, and other devices used

to regulate, warn, or guide traffic, placed on, over, or adjacent to a street, highway, pedestrian facility, or bicycle path by authority of a public agency having jurisdiction.

84. **Traffic Control Signal (Traffic Signal)** - any highway traffic signal by which traffic is alternately directed to stop and permitted to proceed.
85. **Train** - one or more locomotives coupled, with or without cars, that operates on rails or tracks and to which all other traffic must yield the right-of-way by law at highway-rail grade crossings.
86. **Transverse Markings** - pavement markings that are generally placed perpendicular and across the flow of traffic such as shoulder markings, word and symbol markings, stop lines, crosswalk lines, speed measurement markings, parking space markings, and others.
87. **Traveled Way** - the portion of the roadway for the movement of vehicles, exclusive of the shoulders, berms, sidewalks, and parking lanes.
88. **Urban Street** - a type of street normally characterized by relatively low speeds, wide ranges of traffic volumes, narrower lanes, frequent intersections and driveways, significant pedestrian traffic, and more businesses and houses.
89. **Vehicle** - every device in, upon, or by which any person or property can be transported or drawn upon a highway, except trains and light rail transit operating in exclusive or semi-exclusive alignments. Light rail transit operating in a mixed-use alignment, to which other traffic is not required to yield the right-of-way by law, is a vehicle.
90. **Warning Sign** - a sign that gives notice to road users of a situation that might not be readily apparent.
91. **Warrant** - a warrant describes threshold conditions to the engineer in evaluating the potential safety and operational benefits of traffic control devices and is based upon average or normal conditions. Warrants are not a substitute for engineering judgment. The fact that a warrant for a particular traffic control device is met is not conclusive justification for the installation of the device.
92. **Wrong-Way Arrows** - slender, elongated, white pavement marking arrows placed upstream from the ramp terminus to indicate the correct direction of traffic flow. Wrong-way arrows are intended primarily to warn wrong-way road users that they are going in the wrong direction.

Section 1A.14 Abbreviations Used on Traffic Control Devices

Option:

The standard abbreviations for the word messages listed in Table 1A-1 may be used in connection with traffic control devices.

Guidance:

The abbreviations for the words listed in Table 1A-2 should not be used in connection with traffic control devices unless the prompt word shown in Table 1A-2 either precedes or follows the abbreviation.

Standard:

The abbreviations shown in Table 1A-3 shall not be used in connection with traffic control device because of their potential to be misinterpreted by road users.

Table 1A-1. Acceptable Abbreviations

Word Message	Standard Abbreviation
Afternoon / Evening	PM
Alternate	ALT
Avenue	AVE
Bicycle	BIKE
Boulevard	BLVD
Cannot	CANT
CB Radio	CB
Center	CNTR
Civil Defense	CD
Compressed Natural Gas	CNG
Crossing (other than highway-rail)	XING
Diesel Fuel	D
Do Not	DONT
Drive	DR
East	E
Eastbound	EB
Electric Vehicle	EV
Emergency	EMER
Entrance, Enter	ENT
Expressway	EXPWY
Feet	FT
FM Radio	FM
Freeway	FRWY, FWY
Friday	FRI
Hazardous Cargo	HC
Hazardous Material	HAZMAT
High Occupancy Vehicle	HOV
Highway	HWY
Highway-Rail Grade Crossing Pavement Marking	RXR
Hospital	H
Hour(s)	HR
Information	INFO
It Is	ITS
Junction / Intersection	JCT
Kilogram	kg
Kilometer(s)	KM
Kilometers Per Hour	km/h
Lane	LN
Left	LFT

Word Message	Standard Abbreviation
Liquid Propane Gas	LP-GAS
Maintenance	MAINT
Meter(s)	M
Metric Ton	t
Mile(s)	MI
Miles Per Hour	MPH or M.P.H.
Minute(s)	MIN
Monday	MON
Morning / Late Night	AM
Normal	NORM
North	N
Northbound	NB
Parking	PKING
Pedestrian	PED
Pounds	LBS
Right	RHT
Road	RD
Saturday	SAT
Service	SERV
Shoulder	SHLDR
Slippery	SLIP
South	S
Southbound	SB
Speed	SPD
Street	ST
Sunday	SUN
Telephone	PHONE
Temporary	TEMP
Thursday	THURS
Tires With Lugs	LUGS
Tons of Weight	T
Traffic	TRAF
Travelers	TRAVLRS
Tuesday	TUES
Two-Way Intersection	2-WAY
Two-Wheeled Vehicles	CYCLES
US Numbered Route	US
Vehicles	VEH
Warning	WARN
Wednesday	WED
West	W
Westbound	WB
Will Not	WONT

**Table 1A-2. Abbreviations That Are Acceptable
Only With a Prompt Word**

Word	Abbreviation	Prompt Word
Access	ACCS	Road
Ahead	AHD	Fog*
Blocked	BLKD	Lane*
Bridge	BRDG	[Name]*
Condition	COND	Traffic*
Congested	CONG	Traffic*
Construction	CONST	Ahead
Downtown	DWNTN	Traffic*
Eastbound	E-BND	Traffic
Exit	EX, EXT	Next*
Express	EXP	Lane
Frontage	FRNTG	Road
Hazardous	HAZ	Driving
Interstate	I	[Number]
Local	LOC	Traffic
Lower	LWR	Level
Major	MAJ	Accident
Minor	MNR	Accident
Northbound	N-BND	Traffic
Oversized	OVRSZ	Load
Prepare	PREP	To Stop
Pavement	PVMT	Wet*
Quality	QLTY	Air*
Roadwork	RDWK	Ahead [Distance]
Route	RT	Best*
Southbound	S-BND	Traffic
Township	TWNSHP	Limits
Turnpike	TRNPK	[Name]*
Upper	UPR	Level
Vehicle	VEH	Stalled*
Westbound	W-BND	Traffic

* These prompt words should precede the abbreviation

Table 1A-3. Unacceptable Abbreviations

Abbreviation	Intended Word	Common Misinterpretations
ACC	Accident	Access (Road)
CLRS	Clears	Colors
DLY	Delay	Daily
FDR	Feeder	Federal
L	Left	Lane (Merge)
LT	Light (Traffic)	Left
PARK	Parking	Park
POLL	Pollution (Index)	Poll
RED	Reduce	Red
STAD	Stadium	Standard
WRNG	Warning	Wrong



PART 1

General

MUTCD 2000

Manual on Uniform Traffic Control Devices

m i l l e n n i u m e d i t i o n

December 2000



U.S. Department
of Transportation

**Federal Highway
Administration**

PART 1. GENERAL

TABLE OF CONTENTS

	<u>Page</u>
CHAPTER 1A. GENERALDec., 2000
Section 1A.01 Purpose of Traffic Control Devices.....	1A-1
Section 1A.02 Principles of Traffic Control Devices	1A-1
Section 1A.03 Design of Traffic Control Devices	1A-2
Section 1A.04 Placement and Operation of Traffic Control Devices.....	1A-3
Section 1A.05 Maintenance of Traffic Control Devices.....	1A-3
Section 1A.06 Uniformity of Traffic Control Devices	1A-4
Section 1A.07 Responsibility for Traffic Control Devices	1A-4
Section 1A.08 Authority for Placement of Traffic Control Devices	1A-5
Section 1A.09 Engineering Study and Engineering Judgment.....	1A-6
Section 1A.10 Interpretations, Experimentations, and Changes.....	1A-6
Section 1A.11 Relation to Other Documents.....	1A-10
Section 1A.12 Color Code	1A-12
Section 1A.13 Definitions of Words and Phrases in this Manual.....	1A-13
Section 1A.14 Abbreviations Used on Traffic Control Devices.....	1A-23

FIGURES

CHAPTER 1A. GENERAL	
Figure 1A-1 Typical Process for Requesting and Conducting Experimentations for New Traffic Control Devices.....	1A-8
Figure 1A-2 Typical Process for Incorporating New Traffic Control Devices into the MUTCD	1A-11

TABLES

CHAPTER 1A. GENERAL	
Table 1A-1 Acceptable Abbreviations.....	1A-24
Table 1A-2 Abbreviations That Are Acceptable Only With a Prompt Word.....	1A-25
Table 1A-3 Unacceptable Abbreviations.....	1A-26

CHAPTER 1A. GENERAL

Section 1A.01 Purpose of Traffic Control Devices

Support:

The purpose of traffic control devices, as well as the principles for their use, is to promote highway safety and efficiency by providing for the orderly movement of all road users on streets and highways throughout the nation.

Traffic control devices notify road users of regulations and provide warning and guidance needed for the safe, uniform, and efficient operation of all elements of the traffic stream.

Standard:

Traffic control devices or their supports shall not bear any advertising message or any other message that is not related to traffic control.

Support:

Tourist-oriented directional signs and Specific Service signs are not considered advertising; rather, they are classified as motorist service signs.

Section 1A.02 Principles of Traffic Control Devices

Support:

This Manual contains the basic principles that govern the design and use of traffic control devices for all streets and highways open to public travel regardless of type or class or the public agency having jurisdiction. This Manual's text specifies the restriction on the use of a device if it is intended for limited application or for a specific system. It is important that these principles be given primary consideration in the selection and application of each device.

Guidance:

To be effective, a traffic control device should meet five basic requirements:

- A. Fulfill a need,
- B. Command attention,
- C. Convey a clear, simple meaning,
- D. Command respect from road users, and
- E. Give adequate time for proper response.

The following aspects of traffic control devices should be considered to ensure that the above criteria are met: design; placement and operation; maintenance; and uniformity. Vehicle speed should be carefully considered as an element that governs the design, operation, placement, and location of various traffic control devices.

Support:

The definition of the word speed varies depending on its use. The definitions of specific speed terms are contained in Section 1A.13.

Guidance:

The actions required of road users to obey regulatory devices should be specified by State statute, or in cases not covered by State statute, by local ordinance or resolution consistent with the "Uniform Vehicle Code."

The proper use of traffic control devices should provide the reasonable and prudent road user with the information necessary to safely and lawfully use the streets, highways, pedestrian facilities, and bikeways.

Support:

Uniformity of the meaning of traffic control devices is vital to their effectiveness. The meanings ascribed to devices in this Manual are in general accord with the documents mentioned in Section 1A.11.

Section 1A.03 Design of Traffic Control Devices

Guidance:

Devices should be designed so that features such as size, shape, and color, composition, lighting or retroreflection, and contrast are combined to draw attention to the devices; that size, shape, color, and simplicity of message combine to produce a clear meaning; that legibility and size combine with placement to permit adequate time for response; and that uniformity, size, legibility, and reasonableness of the message combine to command respect.

Standard:

All adopted symbol signs are shown in the "Standard Highway Signs" book (see Section 1A.11). All symbols and colors for signs not shown in the "Standard Highway Signs" book shall follow the procedures for experimentation and change described in Section 1A.10. All symbols shall be unmistakably similar to or mirror images of those shown herein. Symbols and colors shall not be modified unless otherwise stated herein.

Guidance:

Aspects of a device's design should be modified only if there is demonstrated need.

Support:

An example of modifying a device's design would be to modify the Side Road (W2-2) sign to show a second offset intersecting road.

Option:

Highway agencies may develop word message signs to notify road users of special regulations or to warn road users of a situation that may not be readily apparent. Unlike with symbol signs and colors, new word message signs may be used without the need for experimentation. With the exception of symbols and colors, minor modifications in the specific design elements of a device may be made provided the essential appearance characteristics are preserved. Although the standard design of symbol signs cannot be modified, it may be appropriate to change the orientation of the symbol to better reflect the direction of travel.

Section 1A.04 Placement and Operation of Traffic Control Devices**Guidance:**

Placement of a traffic control device should be within the road user's view so that maximum visual acuity is provided. To aid in conveying the proper meaning, the traffic control device should be appropriately positioned with respect to the location, object, or situation to which it applies. The location and legibility of the traffic control device should be such that a road user has adequate time to make the proper response in both day and night conditions.

Traffic control devices should be placed and operated in a uniform and consistent manner.

Unnecessary traffic control devices should be removed. The fact that a device is in good physical condition should not be a basis for deferring needed removal or change.

Section 1A.05 Maintenance of Traffic Control Devices**Guidance:**

Traffic control devices should be reviewed periodically to determine if they meet current traffic conditions.

Traffic control devices should be maintained to ensure that legibility is retained, that the device is visible, and that it functions properly in relation to other traffic control devices in the vicinity during both day and night conditions.

Support:

Clean, legible, properly mounted devices in good working condition command the respect of road users.

Section 1A.06 Uniformity of Traffic Control Devices

Support:

Uniformity of devices simplifies the task of the road user because it aids in recognition and understanding, thereby reducing perception/reaction time. Uniformity assists road users, police officers, and traffic courts by giving everyone the same interpretation. Uniformity assists public highway officials through efficiency in manufacture, installation, maintenance, and administration. Uniformity means treating similar situations in a similar way. The use of uniform traffic control devices does not, in itself, constitute uniformity. A standard device used where it is not appropriate is as objectionable as a nonstandard device; in fact, this might be worse, because such misuse might result in disrespect at those locations where the device is needed and appropriate.

Section 1A.07 Responsibility for Traffic Control Devices

Standard:

The responsibility for the design, placement, operation, maintenance, and uniformity of traffic control devices shall rest with the public agency or the official having jurisdiction. 23 CFR 655.603 adopts the Manual on Uniform Traffic Control Devices as the national standard for all traffic control devices installed on any street, highway, or bikeway open to public travel. When a State or other Federal agency manual or supplement is required, they shall be in substantial conformance with the national Manual on Uniform Traffic Control Devices.

23 CFR 655.603 also states that traffic control devices on all streets and highways open to public travel in each State shall be in substantial conformance with standards issued or endorsed by the Federal Highway Administrator.

Support:

The "Uniform Vehicle Code" (see Section 1A.11) has the following provision in Section 15-104 for the adoption of a uniform Manual:

"(a)The [State Highway Agency] shall adopt a manual and specification for a uniform system of traffic control devices consistent with the provisions of this code for use upon

highways within this State. Such uniform system shall correlate with and so far as possible conform to the system set forth in the most recent edition of the Manual on Uniform Traffic Control Devices for Streets and Highways, and other standards issued or endorsed by the Federal Highway Administrator."

"(b) The Manual adopted pursuant to subsection (a) shall have the force and effect of law."

Additionally, States are encouraged to adopt Section 15-117 of the "Uniform Vehicle Code," which states that, "No person shall install or maintain in any area of private property used by the public any sign, signal, marking or other device intended to regulate, warn, or guide traffic unless it conforms with the State manual and specifications adopted under Section 15-104."

Section 1A.08 Authority for Placement of Traffic Control Devices

Standard:

Traffic control devices, advertisements, announcements, and other signs or messages within the highway right-of-way shall be placed only as authorized by a public authority or the official having jurisdiction, for the purpose of regulating, warning, or guiding traffic.

When the public agency or the official having jurisdiction over a street or highway has granted proper authority, others such as contractors and public utility companies shall be permitted to install temporary traffic control devices in temporary traffic control zones. Such traffic control devices shall conform with the Standards of this Manual.

Guidance:

Any unauthorized traffic control device or other sign or message placed on the highway right-of-way by a private organization or individual constitutes a public nuisance and should be removed. All unofficial or non-essential traffic control devices, or other signs or messages should be removed.

Standard:

All regulatory traffic control devices shall be supported by laws, ordinances, or regulations.

Support:

Provisions of this Manual are based upon the concept that effective traffic control depends upon both appropriate application of the devices and reasonable enforcement of the regulations.

Section 1A.09 Engineering Study and Engineering Judgment

Standard:

This Manual describes the application of traffic control devices, but shall not be a legal requirement for their installation.

Guidance:

The decision to use a particular device at a particular location should be made on the basis of either an engineering study or the application of engineering judgment. Thus, while this Manual provides Standards, Guidance, and Options for design and application of traffic control devices, this Manual should not be considered a substitute for engineering judgment.

Engineering judgment should be exercised in the selection and application of traffic control devices, as well as in the location and design of the roads and streets that the devices complement. Jurisdictions with responsibility for traffic control that do not have engineers on their staffs, should seek engineering assistance from others, such as the State transportation agency, their county, a nearby large city, or a traffic engineering consultant.

Section 1A.10 Interpretations, Experimentations, and Changes

Standard:

Design, application, and placement of traffic control devices other than those adopted in this Manual shall be prohibited unless the provisions of this Section are followed.

Support:

Continuing advances in technology will produce changes in the highway, the vehicle, and in road user proficiency; therefore, portions of the system of traffic control devices in this Manual will require updating. In addition, unique situations often arise for device applications that might require interpretation or clarification of this Manual. It is important to have a procedure for recognizing these developments and for introducing new ideas and modifications into the system.

Guidance:

Requests for any interpretation, permission to experiment, or change should be sent to the Federal Highway Administration (FHWA), Office of Transportation Operations, 400 Seventh Street SW, HOTO, Washington, DC 20590.

Support:

An interpretation includes a consideration of the application and operation of standard traffic control devices, official meanings of standard traffic control devices, or the variations from standard device designs.

Guidance:

Requests for an interpretation of this Manual should contain the following information:

- A. A concise statement of the interpretation being sought.
- B. A description of the condition that provoked the need for a revised interpretation.
- C. Any illustration that would be helpful to understand the request.
- D. Any supporting research data that is pertinent to the item to be interpreted.

Support:

Requests to experiment include consideration of testing or evaluating a new traffic control device, its application or manner of use, or a provision not specifically described in this Manual.

A request for permission to experiment will be considered only when submitted by the public agency or private toll facility responsible for the operation of the road or street on which the experiment is to take place.

A diagram indicating the process for experimenting with traffic control devices is shown in Figure 1A-1.

Guidance:

The request for permission to experiment should contain the following:

- A. A statement indicating the nature of the problem.
- B. A description of the proposed change to the traffic control device or application of the traffic control device, how it was developed, the manner in which it deviates from the standard, and how it is expected to be an improvement over existing standards.
- C. Any illustration that would be helpful to understand the traffic control device or use of the traffic control device.

Figure 1A-1. Typical Process for Requesting and Conducting Experimentations for New Traffic Control Devices

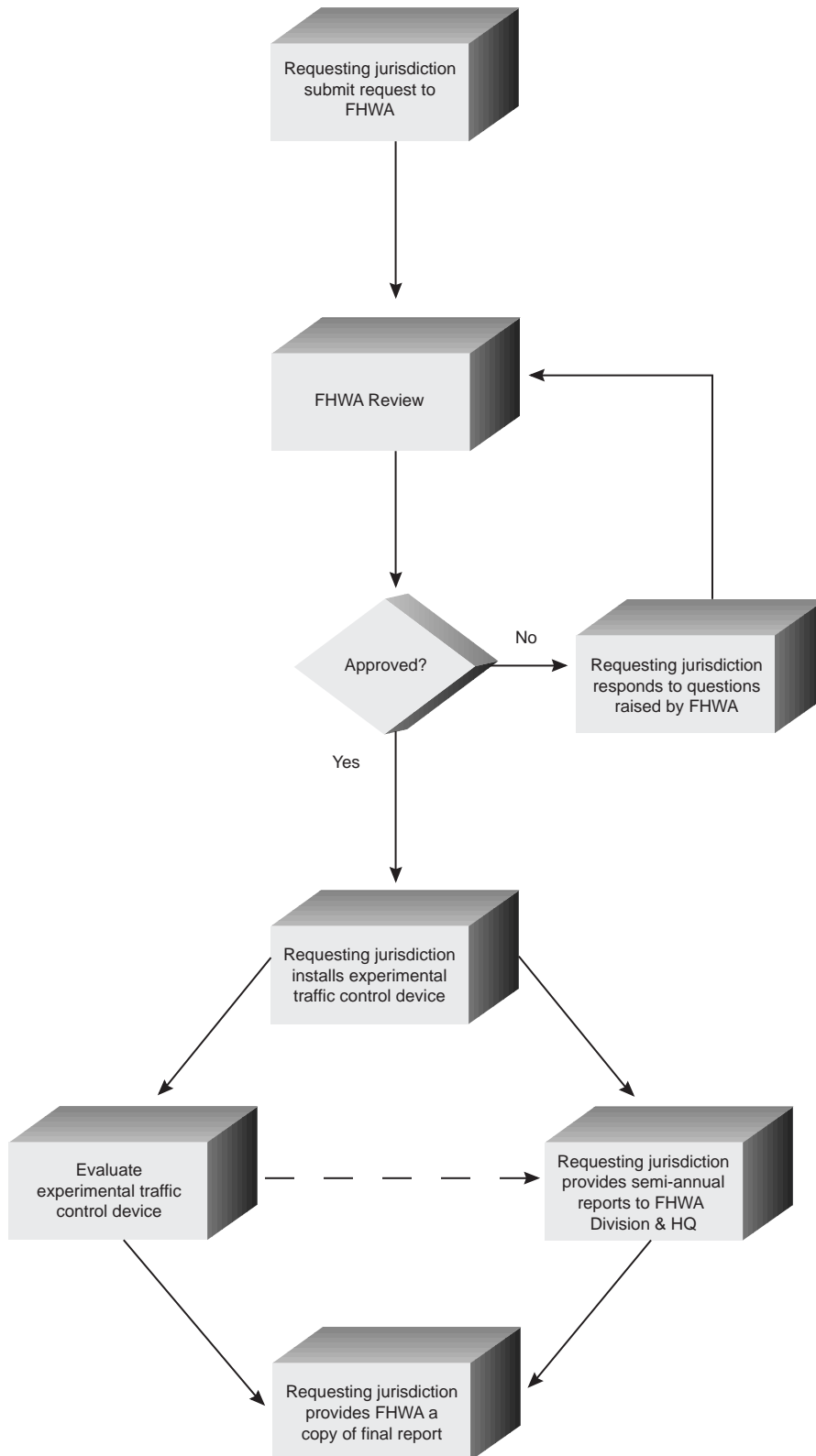

- D. Any supporting data explaining how the traffic control device was developed, if it has been tried, in what ways it was found to be adequate or inadequate, and how this choice of device or application was derived.
- E. A legally-binding statement certifying that the traffic control device is not protected by a patent or copyright.
- F. The time period and location(s) of the experiment.
- G. A detailed research or evaluation plan that must provide for close monitoring of the experimentation, especially in the early stages of its field implementation. The evaluation plan should include before and after studies as well as quantitative data describing the performance of the experimental device.
- H. An agreement to restore the site of the experiment to a condition that complies with the provisions of this Manual within 3 months following the end of the time period of the experiment. This agreement must also provide that the agency sponsoring the experimentation will terminate the experimentation at any time that it determines significant safety concerns are directly or indirectly attributable to the experimentation. The FHWA's Office of Transportation Operations has the right to terminate approval of the experimentation at any time if there is an indication of safety concerns. If, as a result of the experimentation, a request is made that this Manual be changed to include the device or application being experimented with, the device or application will be permitted to remain in place until an official rulemaking action has occurred.
- I. An agreement to provide semiannual progress reports for the duration of the experimentation, and an agreement to provide a copy of the final results of the experimentation to the FHWA's Office of Transportation Operations within 3 months following completion of the experimentation. The FHWA's Office of Transportation Operations has the right to terminate approval of the experimentation if reports are not provided in accordance with this schedule.

Support:

A change includes consideration of a new device to replace a present standard device, an additional device to be added to the list of standard devices, or a revision to a traffic control device application or placement criteria.

Guidance:

Requests for a change to this Manual should contain the following information:

- A. A statement indicating what change is proposed.
- B. Any illustration that would be helpful to understand the request.

C. Any supporting research data that is pertinent to the item to be reviewed.

Support:

A diagram indicating the process for requesting changes to this Manual is shown in Figure 1A-2.

Procedures for revising this Manual are set out in the Federal Register of June 30, 1983 (48 FR 30145).

For additional information concerning interpretations, experimentation, or changes, write to the FHWA, 400 Seventh Street, SW, HOTO, Washington, DC 20590, or visit the MUTCD website at <http://mutcd.fhwa.dot.gov>.

Section 1A.11 Relation to Other Documents

Standard:

To the extent that they are incorporated by specific reference, the latest editions of the following documents, or those editions specifically noted, shall be a part of this Manual: "Standard Alphabets for Highway Signs and Pavement Markings," 1977 Edition (FHWA); "Standard Alphabets for Highway Signs," 1966 Edition (FHWA); "Standard Color Tolerance Limits," (FHWA); and "Standard Highway Signs," 1979 Edition (FHWA).

Support:

For ordering information for the above publications, visit the Federal Highway Administration's MUTCD website at <http://mutcd.fhwa.dot.gov>, or write to the FHWA, 400 Seventh Street, SW, HOTO, Washington, DC 20590.

The latest version of other documents that are useful sources of information with respect to use of this Manual are listed below. See Page i of this Manual for ordering information for the following publications:

- A. "Vehicle Traffic Control Signal Heads," Part 1 - 1985 Edition; Part 2 - 1998 Edition (Institute of Transportation Engineers - ITE)
- B. "Pedestrian Traffic Control Signal Indications," 1985 Edition (ITE)
- C. "Purchase Specification for Flashing and Steady Burn Warning Lights," 1981 Edition (ITE)
- D. "Traffic Signal Lamps," 1980 Edition (ITE)
- E. "Uniform Vehicle Code (UVC) and Model Traffic Ordinance," 1992 Edition (National Committee on Uniform Traffic Laws and Ordinances)

Figure 1A-2. Typical Process for Incorporating New Traffic Control Devices into the MUTCD

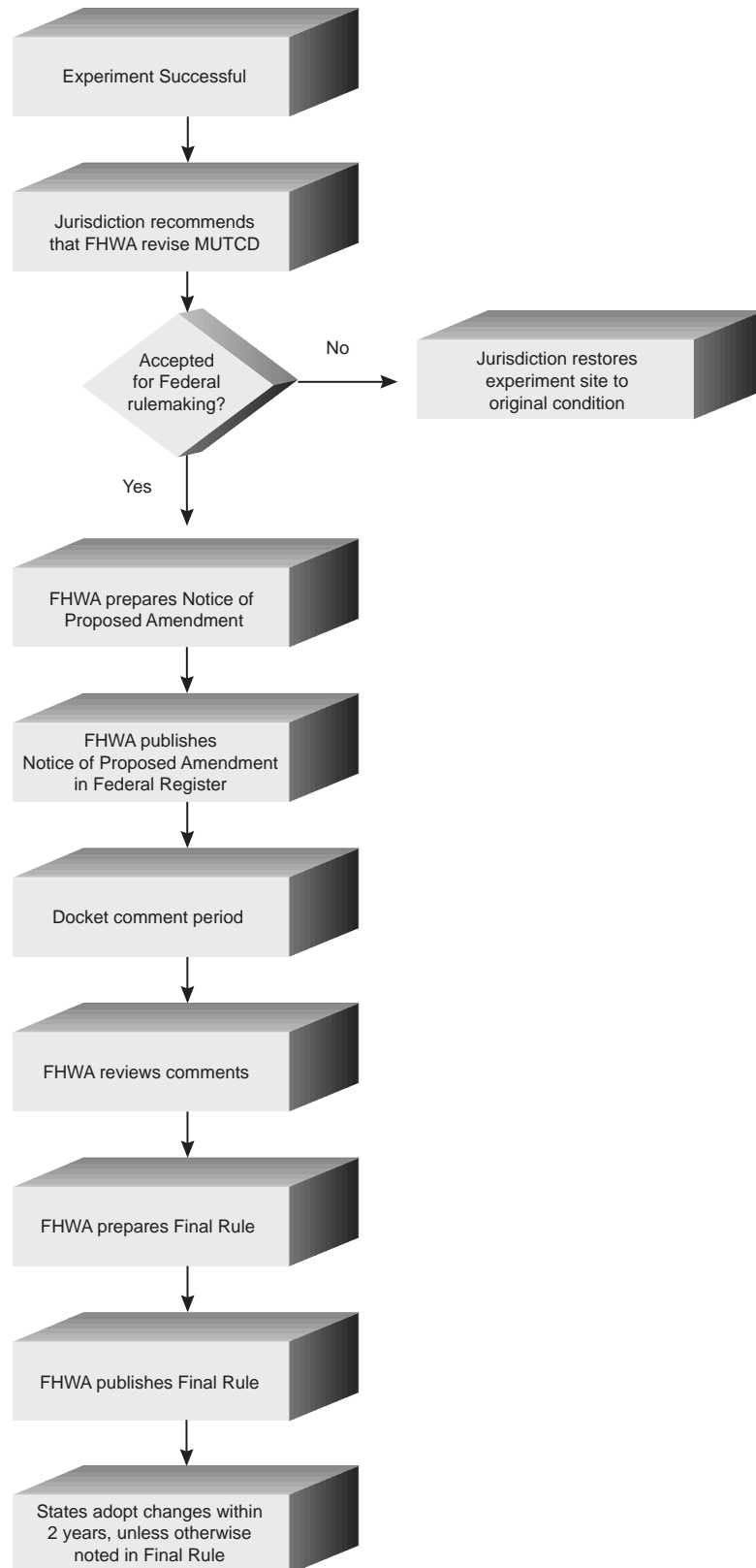

- F. "Traffic Engineering Handbook," 1999 Edition (ITE)
- G. "Highway Capacity Manual," 1998 Edition (Transportation Research Board - TRB)
- H. "A Policy on Geometric Design of Highway and Streets," 1994 Edition (American Association of State Highway and Transportation Officials - AASHTO)
- I. "Guidelines for the Selection of Supplemental Guide Signs for Traffic Generators Adjacent to Freeways," 1993 Edition (AASHTO)
- J. "List of Control Cities for Use in Guide Signs on Interstate Highways," 1993 Edition (AASHTO)
- K. "Manual of Transportation Engineering Studies," 1994 Edition (ITE)
- L. "Roadside Design Guide," 1996 Edition (AASHTO)
- M. "School Trip Safety Program Guidelines," 1984 Edition (ITE)
- N. "Manual of Traffic Signal Design," 1991 Edition (ITE)
- O. "Traffic Detector Handbook," 1991 Edition (ITE)
- P. "2000 AREMA Communications & Signals Manual," American Railway Engineering & Maintenance-of-Way Association (AREMA)
- Q. "Preemption of Traffic Signals at or Near Railroad Grade Crossings with Active Warning Devices," (ITE)
- R. "Highway-Rail Intersection Architecture," U.S. Department of Transportation, Federal Railroad Administration (USDOT/FRA)
- S. "Practice for Roadway Lighting," RP-8, 1983, Illuminating Engineering Society (IES)
- T. "Safety Guide for the Prevention of Radio Frequency Radiation Hazards in the Use of Commercial Electric Detonators (Blasting Caps)," Safety Library Publication No. 20, Institute of Makers of Explosives

Section 1A.12 Color Code

Support:

The following color code establishes general meanings for nine colors of a total of twelve colors that have been identified as being appropriate for use in conveying traffic control information. Central values and tolerance limits for each color are available from the Federal Highway Administration, 400 Seventh Street, SW, HOTO, Washington, DC 20590, and at FHWA's MUTCD website at <http://mutcd.fhwa.dot.gov>.

The three colors for which general meanings have not yet been assigned are being reserved for future applications that will be determined only by FHWA after consultation with the States, the engineering community, and the general public. The meanings described in this Section are of a general nature. More specific assignments of colors are given in the individual Parts of this Manual relating to each class of devices.

Standard:

The general meaning of the 12 colors shall be as follows:

- A. Yellow - warning**
- B. Red - stop or prohibition**
- C. Blue - road user services guidance, tourist information, and evacuation route**
- D. Green - indicated movements permitted, direction guidance**
- E. Brown - recreational and cultural interest area guidance**
- F. Orange - temporary traffic control**
- G. Black - regulation**
- H. White - regulation**
- I. Fluorescent Yellow-Green - pedestrian warning, bicycle warning, school bus and school warning**
- J. Purple - unassigned**
- K. Light Blue - unassigned**
- L. Coral - unassigned**

Section 1A.13 Definitions of Words and Phrases in this Manual

Standard:

Unless otherwise defined herein, or in the other Parts of this Manual, definitions contained in the most recent edition of the "Uniform Vehicle Code," "AASHTO Transportation Glossary (Highway Definitions)," and other documents specified in Section 1A.11 are also incorporated and adopted by reference.

The following words and phrases, when used in this Manual, shall have the following meanings:

- 1. Active Grade Crossing Warning System - the flashing-light signals, with or without warning gates, together with the necessary control equipment used to inform road users of the approach or presence of trains at highway-rail grade crossings.**
- 2. Approach - all lanes of traffic moving towards an intersection or a mid-block location from one direction, including any adjacent parking lane(s).**
- 3. Arterial Highway (Street) - a general term denoting a highway primarily used by through traffic, usually on a continuous route or a highway designated as part of an arterial system.**
- 4. Average Day - a day representing traffic volumes normally and repeatedly found at a location, typically a weekday when volumes are influenced by employment or a weekend when volumes are influenced by entertainment or recreation.**
- 5. Beacon - a highway traffic signal with one or more signal sections that operates in a flashing mode.**
- 6. Bicycle - a pedal-powered vehicle upon which the human operator sits.**
- 7. Bicycle Lane - a portion of a roadway that has been designated by signs and pavement markings for preferential or exclusive use by bicyclists.**
- 8. Centerline Markings - the yellow pavement marking line(s) that delineates the separation of traffic lanes that have opposite directions of travel on a roadway. These markings need not be at the geometrical center of the pavement.**
- 9. Changeable Message Signs - signs that are capable of displaying more than one message, changeable manually, by remote control, or by automatic control. These signs are referred to as Dynamic Message Signs in the National Intelligent Transportation Systems (ITS) Architecture.**
- 10. Channelizing Line Marking - a wide or double solid white line used to form islands where traffic in the same direction of travel is permitted on both sides of the island.**
- 11. Circular Intersection - an intersection that has an island, generally circular in design, located in the center of the intersection where traffic passes to the**

right of the island. Circular intersections include roundabouts, rotaries, and traffic circles.

- 12. Clear Zone - the total roadside border area, starting at the edge of the traveled way, that is wide enough to allow an errant driver to stop or regain control of a vehicle. This area might consist of a shoulder, a recoverable slope, and/or a non-recoverable, traversable slope with a clear run-out area at its toe.**
- 13. Concurrent Flow HOV Lane - an HOV lane that is operated in the same direction as the adjacent mixed flow lanes, separated from the adjacent general purpose freeway lanes by a standard lane stripe, painted buffer, or barrier.**
- 14. Contraflow Lane - a lane operating in a direction opposite to the normal flow of traffic designated for peak direction of travel during at least a portion of the day. Contraflow lanes are usually separated from the off-peak direction lanes by plastic pylons, or by moveable or permanent barrier.**
- 15. Conventional Road - a street or highway other than a low-volume road (as defined in Section 5A.01), expressway, or freeway.**
- 16. Collector Highway - a term denoting a highway that in rural areas connects small towns and local highways to arterial highways, and in urban areas provides land access and traffic circulation within residential, commercial and business areas and connects local highways to the arterial highways.**
- 17. Crosswalk - (a) that part of a roadway at an intersection included within the connections of the lateral lines of the sidewalks on opposite sides of the highway measured from the curbs or in the absence of curbs, from the edges of the traversable roadway, and in the absence of a sidewalk on one side of the roadway, the part of a roadway included within the extension of the lateral lines of the sidewalk at right angles to the centerline; (b) any portion of a roadway at an intersection or elsewhere distinctly indicated for pedestrian crossing by lines or other markings on the surface.**
- 18. Crosswalk Lines - white pavement marking lines that identify a crosswalk.**
- 19. Delineators - retroreflective devices mounted on the roadway surface or at the side of the roadway in a series to indicate the alignment of the roadway, especially at night or in adverse weather.**
- 20. Dynamic Envelope - the clearance required for the train and its cargo overhang due to any combination of loading, lateral motion, or suspension failure.**

- 21. Edge Line Markings - white or yellow pavement marking lines that delineate the right or left edge(s) of a traveled way.**
- 22. End-of-Roadway Marker - a device used to warn and alert road users of the end of a roadway in other than temporary traffic control zones.**
- 23. Engineering Judgment - the evaluation of available pertinent information, and the application of appropriate principles, Standards, Guidance, and practices as contained in this Manual and other sources, for the purpose of deciding upon the applicability, design, operation, or installation of a traffic control device. Engineering judgment shall be exercised by an engineer, or by an individual working under the supervision of an engineer, through the application of procedures and criteria established by the engineer. Documentation of engineering judgment is not required.**
- 24. Engineering Study - the comprehensive analysis and evaluation of available pertinent information, and the application of appropriate principles, Standards, Guidance, and practices as contained in this Manual and other sources, for the purpose of deciding upon the applicability, design, operation, or installation of a traffic control device. An engineering study shall be performed by an engineer, or by an individual working under the supervision of an engineer, through the application of procedures and criteria established by the engineer. An engineering study shall be documented.**
- 25. Expressway - a divided highway with partial control of access.**
- 26. Flashing (Flashing Mode) - a mode of operation in which a traffic signal indication is turned on and off repetitively.**
- 27. Freeway - a divided highway with full control of access.**
- 28. Guide Signs - a sign that shows route designations, destinations, directions, distances, services, points of interest, or other geographical, recreational, or cultural information.**
- 29. High Occupancy Vehicle (HOV) - a motor vehicle carrying at least two or more persons, including carpools, vanpools, and buses.**
- 30. Highway - a general term for denoting a public way for purposes of travel by vehicular travel, including the entire area within the right-of-way.**
- 31. Highway-Rail Grade Crossing - the general area where a highway and a railroad's right-of-way cross at the same level, within which are included the**

railroad tracks, highway, and traffic control devices for highway traffic traversing that area.

- 32. Highway Traffic Signal - a power-operated traffic control device by which traffic is warned or directed to take some specific action. These devices do not include power-operated signs, illuminated pavement markers, barricade warning lights, or steady burning electric lamps.**
- 33. HOV Lane - any preferential lane designated for exclusive use by high-occupancy vehicles for all or part of a day--including a designated lane on a freeway, other highway, street, or independent roadway on a separate right-of-way.**
- 34. Interchange - a system of interconnecting roadways providing for traffic movement between two or more highways that do not intersect at grade.**
- 35. Intermediate Interchange - an interchange with an urban or rural route that is not a major or minor interchange as defined herein.**
- 36. Intersection - (a) the area embraced within the prolongation or connection of the lateral curb lines, or if none, the lateral boundary lines of the roadways of two highways that join one another at, or approximately at, right angles, or the area within which vehicles traveling on different highways that join at any other angle may come into conflict; (b) the junction of an alley or driveway with a roadway or highway shall not constitute an intersection.**
- 37. Island - a defined area between traffic lanes for control of vehicular movements or for pedestrian refuge. It includes all end protection and approach treatments. Within an intersection area, a median or an outer separation is considered to be an island.**
- 38. Lane Line Markings - white pavement marking lines that delineate the separation of traffic lanes that have the same direction of travel on a roadway.**
- 39. Lane-Use Control Signal - a signal face displaying indications to permit or prohibit the use of specific lanes of a roadway or to indicate the impending prohibition of such use.**
- 40. Legend - See Sign Legend.**
- 41. Logo - a distinctive emblem, symbol, or trademark that identifies a product or service.**
- 42. Longitudinal Markings - pavement markings that are generally placed**

parallel and adjacent to the flow of traffic such as lane lines, centerlines, edge lines, channelizing lines, and others.

- 43. Major Interchange - an interchange with another freeway or expressway, or an interchange with a high-volume multi-lane highway, principal urban arterial, or major rural route where the interchanging traffic is heavy or includes many road users unfamiliar with the area.**
- 44. Major Street - the street normally carrying the higher volume of vehicular traffic.**
- 45. Median - the area between two roadways of a divided highway measured from edge of traveled way to edge of traveled way. The median excludes turn lanes. The median width might be different between intersections, interchanges, and at opposite approaches of the same intersection.**
- 46. Minor Interchange - an interchange where traffic is local and very light, such as interchanges with land service access roads. Where the sum of the exit volumes is estimated to be lower than 100 vehicles per day in the design year, the interchange is classified as local.**
- 47. Minor Street - the street normally carrying the lower volume of vehicular traffic.**
- 48. Object Markers - devices used to mark obstructions within or adjacent to the roadway.**
- 49. Occupancy Requirement - any restriction that regulates the use of a facility for any period of the day based on a specified number of persons in a vehicle.**
- 50. Occupants - the people driving or riding in a car, truck, bus, or other vehicle.**
- 51. Paved - a bituminous surface treatment, mixed bituminous concrete, or Portland cement concrete roadway surface that has both a structural (weight bearing) and a sealing purpose for the roadway.**
- 52. Pedestrian - a person afoot, in a wheelchair, on skates, or on a skateboard.**
- 53. Platoon - a group of vehicles or pedestrians traveling together as a group, either voluntarily or involuntarily, because of traffic signal controls, geometrics, or other factors.**
- 54. Preferential Lane Marking - white lines formed in a diamond shape.**

- 55. Principal Legend - place names, street names, and route numbers placed on guide signs.**
- 56. Public Road - any road or street under the jurisdiction of and maintained by a public agency and open to public travel.**
- 57. Raised Pavement Marker - a device with a height of at least 10 mm (0.4 in) mounted on or in a road surface and intended to supplement or substitute for pavement markings.**
- 58. Regulatory Signs - a sign that gives notice to road users of traffic laws or regulations.**
- 59. Retroreflectivity - a property of a surface that allows a large portion of the light coming from a point source to be returned directly back to a point near its origin.**
- 60. Right-of-Way [Assignment] - the permitting of vehicles and/or pedestrians to proceed in a lawful manner in preference to other vehicles or pedestrians by the display of sign or signal indications.**
- 61. Road - see Roadway.**
- 62. Roadway - that portion of a highway improved, designed, or ordinarily used for vehicular travel and parking lanes, but exclusive of the sidewalk, berm, or shoulder even though such sidewalk, berm, or shoulder is used by persons riding bicycles or other human-powered vehicles. In the event a highway includes two or more separate roadways, the term roadway as used herein shall refer to any such roadway separately, but not to all such roadways collectively.**
- 63. Roadway Network - a geographical arrangement of intersecting roadways.**
- 64. Road User - a vehicle operator, bicyclist, or pedestrian within the highway, including workers in temporary traffic control zones.**
- 65. Rumble Strip - a series of intermittent, narrow, transverse areas of rough-textured, slightly-raised, or depressed road surface that is installed to alert road users to unusual traffic conditions.**
- 66. Rural Highway - a type of roadway normally characterized by lower volumes, higher speeds, fewer turning conflicts, and less conflict with pedestrians.**
- 67. Shared Roadway - a roadway that is officially designated and marked as a**

bicycle route, but which is open to motor vehicle travel and upon which no bicycle lane is designated.

- 68. Shared-Use Path - a bikeway physically separated from motorized vehicular traffic by an open space or barrier and either within the highway right-of-way or within an independent alignment. Shared-use paths might also be used by pedestrians, skaters, wheelchair users, joggers, and other non-motorized users.**
- 69. Sidewalk - that portion of a street between the curb line, or the lateral line of a roadway, and the adjacent property line or on easements of private property, intended for use by pedestrians.**
- 70. Sign - any traffic control device that is intended to communicate specific information to road users through a word or symbol legend. Signs do not include traffic control signals, pavement markings, delineators, or channelization devices.**
- 71. Sign Assembly - a group of signs, located on the same support(s), that supplement one another in conveying information to road users.**
- 72. Sign Illumination - either internal or external lighting that shows similar color by day or night. Street, highway, or strobe lighting shall not be considered as meeting this definition.**
- 73. Sign Legend - all word messages, logos, and symbol designs that are intended to convey specific meanings.**
- 74. Sign Panel - a separate panel or piece of material containing a word or symbol legend that is affixed to the face of a sign.**
- 75. Speed - speed is defined based on the following classifications:**
 - (a) Advisory Speed - a recommended speed for all vehicles operating on a section of highway and based on the highway design, operating characteristics, and conditions.**
 - (b) Average Speed - the summation of the instantaneous or spot-measured speeds at a specific location of vehicles divided by the number of vehicles observed.**
 - (c) Design Speed - a selected speed used to determine the various geometric design features of a roadway.**

- (d) **85th-Percentile Speed** - The speed at or below which 85 percent of the motorized vehicles travel.
 - (e) **Operating Speed** - a speed at which a typical vehicle or the overall traffic operates. Operating speed may be defined with speed values such as the average, pace, or 85th-percentile speeds.
 - (f) **Pace Speed** - the highest speed within a specific range of speeds that represents more vehicles than in any other like range of speed. The range of speeds typically used is 10 km/h or 10 mph.
 - (g) **Posted Speed** - the speed limit determined by law and shown on Speed Limit signs.
 - (h) **Statutory Speed** - a speed limit established by legislative action that typically is applicable for highways with specified design, functional, jurisdictional and/or location characteristic and is not necessarily shown on Speed Limit signs.
- 76. Speed Limit** - the maximum (or minimum) speed applicable to a section of highway as established by law.
- 77. Speed Measurement Marking** - a white transverse pavement marking placed on the roadway to assist the enforcement of speed regulations.
- 78. Speed Zone** - a section of highway with a speed limit that is established by law but which may be different from a legislatively-specified statutory speed limit.
- 79. Stop Line** - a solid white pavement marking line extending across approach lanes to indicate the point at which a stop is intended or required to be made.
- 80. Street** - see Highway.
- 81. Temporary Traffic Control Zone** - an area of a highway where road user conditions are changed because of a work zone or incident by the use of temporary traffic control devices, flaggers, police, or other authorized personnel.
- 82. Traffic** - pedestrians, bicyclists, ridden or herded animals, vehicles, streetcars, and other conveyances either singularly or together while using any highway for purposes of travel.
- 83. Traffic Control Devices** - all signs, signals, markings, and other devices used

to regulate, warn, or guide traffic, placed on, over, or adjacent to a street, highway, pedestrian facility, or bicycle path by authority of a public agency having jurisdiction.

- 84. Traffic Control Signal (Traffic Signal) - any highway traffic signal by which traffic is alternately directed to stop and permitted to proceed.**
- 85. Train - one or more locomotives coupled, with or without cars, that operates on rails or tracks and to which all other traffic must yield the right-of-way by law at highway-rail grade crossings.**
- 86. Transverse Markings - pavement markings that are generally placed perpendicular and across the flow of traffic such as shoulder markings, word and symbol markings, stop lines, crosswalk lines, speed measurement markings, parking space markings, and others.**
- 87. Traveled Way - the portion of the roadway for the movement of vehicles, exclusive of the shoulders, berms, sidewalks, and parking lanes.**
- 88. Urban Street - a type of street normally characterized by relatively low speeds, wide ranges of traffic volumes, narrower lanes, frequent intersections and driveways, significant pedestrian traffic, and more businesses and houses.**
- 89. Vehicle - every device in, upon, or by which any person or property can be transported or drawn upon a highway, except trains and light rail transit operating in exclusive or semi-exclusive alignments. Light rail transit operating in a mixed-use alignment, to which other traffic is not required to yield the right-of-way by law, is a vehicle.**
- 90. Warning Sign - a sign that gives notice to road users of a situation that might not be readily apparent.**
- 91. Warrant - a warrant describes threshold conditions to the engineer in evaluating the potential safety and operational benefits of traffic control devices and is based upon average or normal conditions. Warrants are not a substitute for engineering judgment. The fact that a warrant for a particular traffic control device is met is not conclusive justification for the installation of the device.**
- 92. Wrong-Way Arrows - slender, elongated, white pavement marking arrows placed upstream from the ramp terminus to indicate the correct direction of traffic flow. Wrong-way arrows are intended primarily to warn wrong-way road users that they are going in the wrong direction.**

Section 1A.14 Abbreviations Used on Traffic Control Devices

Option:

The standard abbreviations for the word messages listed in Table 1A-1 may be used in connection with traffic control devices.

Guidance:

The abbreviations for the words listed in Table 1A-2 should not be used in connection with traffic control devices unless the prompt word shown in Table 1A-2 either precedes or follows the abbreviation.

Standard:

The abbreviations shown in Table 1A-3 shall not be used in connection with traffic control device because of their potential to be misinterpreted by road users.

Table 1A-1. Acceptable Abbreviations

Word Message	Standard Abbreviation
Afternoon / Evening	PM
Alternate	ALT
Avenue	AVE
Bicycle	BIKE
Boulevard	BLVD
Cannot	CANT
CB Radio	CB
Center	CNTR
Civil Defense	CD
Compressed Natural Gas	CNG
Crossing (other than highway-rail)	XING
Diesel Fuel	D
Do Not	DONT
Drive	DR
East	E
Eastbound	EB
Electric Vehicle	EV
Emergency	EMER
Entrance, Enter	ENT
Expressway	EXPWY
Feet	FT
FM Radio	FM
Freeway	FRWY, FWY
Friday	FRI
Hazardous Cargo	HC
Hazardous Material	HAZMAT
High Occupancy Vehicle	HOV
Highway	HWY
Highway-Rail Grade Crossing Pavement Marking	RXR
Hospital	H
Hour(s)	HR
Information	INFO
It Is	ITS
Junction / Intersection	JCT
Kilogram	kg
Kilometer(s)	KM
Kilometers Per Hour	km/h
Lane	LN
Left	LFT

Word Message	Standard Abbreviation
Liquid Propane Gas	LP-GAS
Maintenance	MAINT
Meter(s)	M
Metric Ton	t
Mile(s)	MI
Miles Per Hour	MPH or M.P.H.
Minute(s)	MIN
Monday	MON
Morning / Late Night	AM
Normal	NORM
North	N
Northbound	NB
Parking	PKING
Pedestrian	PED
Pounds	LBS
Right	RHT
Road	RD
Saturday	SAT
Service	SERV
Shoulder	SHLDR
Slippery	SLIP
South	S
Southbound	SB
Speed	SPD
Street	ST
Sunday	SUN
Telephone	PHONE
Temporary	TEMP
Thursday	THURS
Tires With Lugs	LUGS
Tons of Weight	T
Traffic	TRAF
Travelers	TRAVLRS
Tuesday	TUES
Two-Way Intersection	2-WAY
Two-Wheeled Vehicles	CYCLES
US Numbered Route	US
Vehicles	VEH
Warning	WARN
Wednesday	WED
West	W
Westbound	WB
Will Not	WONT

**Table 1A-2. Abbreviations That Are Acceptable
Only With a Prompt Word**

Word	Abbreviation	Prompt Word
Access	ACCS	Road
Ahead	AHD	Fog*
Blocked	BLKD	Lane*
Bridge	BRDG	[Name]*
Condition	COND	Traffic*
Congested	CONG	Traffic*
Construction	CONST	Ahead
Downtown	DWNTN	Traffic*
Eastbound	E-BND	Traffic
Exit	EX, EXT	Next*
Express	EXP	Lane
Frontage	FRNTG	Road
Hazardous	HAZ	Driving
Interstate	I	[Number]
Local	LOC	Traffic
Lower	LWR	Level
Major	MAJ	Accident
Minor	MNR	Accident
Northbound	N-BND	Traffic
Oversized	OVRSZ	Load
Prepare	PREP	To Stop
Pavement	PVMT	Wet*
Quality	QLTY	Air*
Roadwork	RDWK	Ahead [Distance]
Route	RT	Best*
Southbound	S-BND	Traffic
Township	TWNSHP	Limits
Turnpike	TRNPK	[Name]*
Upper	UPR	Level
Vehicle	VEH	Stalled*
Westbound	W-BND	Traffic

* These prompt words should precede the abbreviation

Table 1A-3. Unacceptable Abbreviations

Abbreviation	Intended Word	Common Misinterpretations
ACC	Accident	Access (Road)
CLRS	Clears	Colors
DLY	Delay	Daily
FDR	Feeder	Federal
L	Left	Lane (Merge)
LT	Light (Traffic)	Left
PARK	Parking	Park
POLL	Pollution (Index)	Poll
RED	Reduce	Red
STAD	Stadium	Standard
WRNG	Warning	Wrong



PART 2

Signs

MUTCD 2000

Manual on Uniform Traffic Control Devices

m i l l e n n i u m e d i t i o n

December 2000



U.S. Department
of Transportation

**Federal Highway
Administration**

PART 2. SIGNS

TABLE OF CONTENTS

	<u>Page</u>
CHAPTER 2A. GENERAL	Dec., 2000
Section 2A.01 Function and Purpose of Signs	2A-1
Section 2A.02 Definitions	2A-1
Section 2A.03 Standardization of Application.....	2A-2
Section 2A.04 Excessive Use of Signs	2A-2
Section 2A.05 Classification of Signs.....	2A-3
Section 2A.06 Design of Signs	2A-3
Section 2A.07 Changeable Message Signs	2A-4
Section 2A.08 Retroreflectivity and Illumination.....	2A-5
Section 2A.09 Minimum Retroreflectivity Levels.....	2A-5
Section 2A.10 Shapes.....	2A-5
Section 2A.11 Sign Colors	2A-8
Section 2A.12 Dimensions	2A-8
Section 2A.13 Symbols	2A-10
Section 2A.14 Word Messages.....	2A-10
Section 2A.15 Sign Borders	2A-11
Section 2A.16 Standardization of Location	2A-11
Section 2A.17 Overhead Sign Installations	2A-20
Section 2A.18 Mounting Height	2A-21
Section 2A.19 Lateral Offset.....	2A-22
Section 2A.20 Position of Signs.....	2A-23
Section 2A.21 Orientation	2A-24
Section 2A.22 Posts and Mountings	2A-24
Section 2A.23 Maintenance	2A-24
Section 2A.24 Wrong-Way Traffic Control	2A-25
 CHAPTER 2B. REGULATORY SIGNS	 Dec., 2000
Section 2B.01 Application of Regulatory Signs	2B-1
Section 2B.02 Design of Regulatory Signs.....	2B-1
Section 2B.03 Size of Regulatory Signs	2B-1
Section 2B.04 STOP Sign (R1-1).....	2B-6
Section 2B.05 STOP Sign Applications	2B-8
Section 2B.06 STOP Sign Placement.....	2B-9
Section 2B.07 Multi-Way Stop Applications	2B-10
Section 2B.08 YIELD Sign (R1-2)	2B-11
Section 2B.09 YIELD Sign Applications.....	2B-12
Section 2B.10 YIELD Sign Placement	2B-12
Section 2B.11 Speed Limit Sign (R2-1)	2B-13
Section 2B.12 Truck Speed Limit Sign (R2-2).....	2B-14
Section 2B.13 Night Speed Limit Sign (R2-3)	2B-14

Section 2B.14 Minimum Speed Limit Sign (R2-4)2B-14

Section 2B.15 Location of Speed Limit Signs2B-16

Section 2B.16 Reduced Speed Ahead Signs (R2-5 Series).....2B-16

Section 2B.17 Turn Prohibition Signs (R3-1 through R3-4)2B-17

Section 2B.18 Intersection Lane Control Signs (R3-5 through R3-8).....2B-18

Section 2B.19 Mandatory Movement Lane Control Signs (R3-5, R3-5a, and R3-7)
.....2B-20

Section 2B.20 Optional Movement Lane Control Sign (R3-6)2B-21

Section 2B.21 Advance Intersection Lane Control Signs (R3-8 Series)2B-22

Section 2B.22 Two-Way Left Turn Only Signs (R3-9a, R3-9b).....2B-22

Section 2B.23 Reversible Lane Control Signs (R3-9c through R3-9i).....2B-24

Section 2B.24 DO NOT PASS Sign (R4-1).....2B-28

Section 2B.25 PASS WITH CARE Sign (R4-2).....2B-28

Section 2B.26 SLOWER TRAFFIC KEEP RIGHT Sign (R4-3).....2B-28

Section 2B.27 Slow Moving Traffic Lane Signs (R4-5, R4-6)2B-30

Section 2B.28 Keep Right and Keep Left Signs (R4-7, R4-8).....2B-30

Section 2B.29 DO NOT ENTER Sign (R5-1)2B-31

Section 2B.30 WRONG WAY Sign (R5-1a).....2B-31

Section 2B.31 Selective Exclusion Signs.....2B-34

Section 2B.32 ONE WAY Signs (R6-1, R6-2).....2B-35

Section 2B.33 Divided Highway Crossing Signs (R6-3, R6-3a).....2B-36

Section 2B.34 Parking, Standing, and Stopping Signs (R7 and R8 Series)2B-37

Section 2B.35 Design of Parking, Standing, and Stopping Signs2B-37

Section 2B.36 Placement of Parking, Stopping, and Standing Signs2B-41

Section 2B.37 Emergency Restriction Signs (R8-4, R8-7, R8-8).....2B-42

Section 2B.38 WALK ON LEFT FACING TRAFFIC and No Hitchhiking Signs
(R9-1, R9-4, R9-4a).....2B-42

Section 2B.39 Pedestrian Crossing Signs (R9-2, R9-3)2B-42

Section 2B.40 Traffic Signal Signs (R10-1 through R10-13).....2B-44

Section 2B.41 KEEP OFF MEDIAN Sign (R11-1).....2B-47

Section 2B.42 ROAD CLOSED Sign (R11-2) and LOCAL TRAFFIC ONLY Signs
(R11-3 Series, R11-4)2B-49

Section 2B.43 Weight Limit Signs (R12-1 through R12-5)2B-49

Section 2B.44 Weigh Station Signs (R13 Series)2B-50

Section 2B.45 Truck Route Sign (R14-1).....2B-50

Section 2B.46 Hazardous Cargo Signs (R14-2, R14-3).....2B-52

Section 2B.47 National Network Signs (R14-4, R14-5).....2B-52

Section 2B.48 Preferential Lane Signs (R3-10 through R3-17)2B-52

Section 2B.49 High-Occupancy Vehicle (HOV) Lanes2B-56

Section 2B.50 High-Occupancy Vehicle Sign Applications and Placement.....2B-57

Section 2B.51 Other Regulatory Signs2B-58

CHAPTER 2C. WARNING SIGNSDec., 2000

Section 2C.01 Function of Warning Signs2C-1

Section 2C.02 Application of Warning Signs2C-1

Section 2C.03 Design of Warning Signs2C-1

Section 2C.04 Size of Warning Signs2C-3

Section 2C.05 Placement of Warning Signs.....2C-3

Section 2C.06	Horizontal Alignment Signs (W1-1 through W1-5).....	2C-8
Section 2C.07	Combination Horizontal Alignment/Advisory Speed Sign (W1-9)	2C-8
Section 2C.08	Combination Horizontal Alignment/Intersection Sign (W1-10).....	2C-10
Section 2C.09	One-Direction Large Arrow Sign (W1-6)	2C-10
Section 2C.10	Chevron Alignment Sign (W1-8)	2C-11
Section 2C.11	Hill Signs (W7-1, W7-1a, W7-1b)	2C-12
Section 2C.12	Truck Escape Ramp Signs (W7-4 Series)	2C-12
Section 2C.13	ROAD NARROWS Sign (W5-1).....	2C-14
Section 2C.14	NARROW BRIDGE Sign (W5-2)	2C-14
Section 2C.15	ONE LANE BRIDGE Sign (W5-3).....	2C-16
Section 2C.16	Divided Highway (Road) Sign (W6-1)	2C-16
Section 2C.17	Divided Highway (Road) Ends Sign (W6-2)	2C-16
Section 2C.18	Double Arrow Sign (W12-1).....	2C-17
Section 2C.19	DEAD END/NO OUTLET Signs (W14-1, W14-2)	2C-17
Section 2C.20	Low Clearance Signs (W12-2 and W12-2P).....	2C-18
Section 2C.21	BUMP and DIP Signs (W8-1, W8-2).....	2C-18
Section 2C.22	SPEED HUMP Sign (W17-1)	2C-20
Section 2C.23	PAVEMENT ENDS Sign (W8-3).....	2C-20
Section 2C.24	Shoulder Signs (W8-4, W8-9, W8-9a, and W8-11)	2C-21
Section 2C.25	Slippery When Wet Sign (W8-5).....	2C-21
Section 2C.26	Advance Traffic Control Signs (W3-1, W3-2, W3-3, W3-4).....	2C-22
Section 2C.27	CROSS TRAFFIC DOES NOT STOP Plaque (W4-4P).....	2C-23
Section 2C.28	Merge Sign (W4-1).....	2C-24
Section 2C.29	Added Lane Sign (W4-3)	2C-25
Section 2C.30	Lane Ends Signs (W9-1, W9-2)	2C-25
Section 2C.31	Two-Way Traffic Sign (W6-3)	2C-26
Section 2C.32	NO PASSING ZONE Sign (W14-3)	2C-26
Section 2C.33	Advisory Exit, Ramp, and Curve Speed Signs (W13-2, W13-3, W13-5)	2C-26
Section 2C.34	Intersection Warning Signs (W2-1 through W2-6)	2C-28
Section 2C.35	Two-Direction Large Arrow Sign (W1-7).....	2C-29
Section 2C.36	Motorized Traffic Signs (W8-6, W11-5, W11-8, W11-10).....	2C-30
Section 2C.37	Crossing Signs (W11-1, W11-2, W11-3, W11-4, W16-7P).....	2C-30
Section 2C.38	Playground Sign (W15-1).....	2C-32
Section 2C.39	Use of Supplemental Plaques	2C-34
Section 2C.40	Design of Supplemental Plaques	2C-34
Section 2C.41	Distance Plaques (W16-2, W16-3, W16-4, W7-3a).....	2C-34
Section 2C.42	Advisory Speed Plaque (W13-1).....	2C-35
Section 2C.43	Supplemental Arrow Plaques (W16-5P, W16-6P)	2C-35
Section 2C.44	Hill-Related Plaques (W7-2 and W7-3)	2C-35
Section 2C.45	Advance Street Name Plaque (W16-8)	2C-36
Section 2C.46	DEAD END/NO OUTLET Plaques (W14-1P, W14-2P).....	2C-36
Section 2C.47	SHARE THE ROAD Plaque (W16-1)	2C-36

CHAPTER 2D. GUIDE SIGNS – CONVENTIONAL ROADS Dec., 2000

Section 2D.01	Scope of Conventional Road Guide Sign Standards 	2D-1
Section 2D.02	Application	2D-1
Section 2D.03	Color, Retroreflection, and Illumination	2D-1

Section 2D.04	Size of Signs	2D-1
Section 2D.05	Lettering Style	2D-2
Section 2D.06	Size of Lettering	2D-2
Section 2D.07	Amount of Legend	2D-3
Section 2D.08	Arrows	2D-3
Section 2D.09	Numbered Highway Systems	2D-5
Section 2D.10	Route Signs and Auxiliary Signs	2D-6
Section 2D.11	Design of Route Signs	2D-6
Section 2D.12	Design of Route Sign Auxiliaries	2D-9
Section 2D.13	Junction Auxiliary Sign (M2-1)	2D-10
Section 2D.14	Combination Junction Sign (M2-2)	2D-10
Section 2D.15	Cardinal Direction Auxiliary Signs (M3-1 through M3-4)	2D-12
Section 2D.16	Auxiliary Signs for Alternative Routes (M4 Series)	2D-12
Section 2D.17	ALTERNATE Auxiliary Signs (M4-1, M4-1a)	2D-12
Section 2D.18	BY-PASS Auxiliary Sign (M4-2)	2D-13
Section 2D.19	BUSINESS Auxiliary Sign (M4-3)	2D-13
Section 2D.20	TRUCK Auxiliary Sign (M4-4)	2D-13
Section 2D.21	TO Auxiliary Sign (M4-5)	2D-13
Section 2D.22	END Auxiliary Sign (M4-6)	2D-14
Section 2D.23	TEMPORARY Auxiliary Sign (M4-7)	2D-14
Section 2D.24	Temporary Detour and Auxiliary Signs	2D-14
Section 2D.25	Advance Turn Arrow Auxiliary Signs (M5-1, M5-2)	2D-15
Section 2D.26	Directional Arrow Auxiliary Signs (M6 Series)	2D-15
Section 2D.27	Route Sign Assemblies	2D-15
Section 2D.28	Junction Assembly	2D-17
Section 2D.29	Advance Route Turn Assembly	2D-21
Section 2D.30	Directional Assembly	2D-22
Section 2D.31	Confirming or Reassurance Assemblies	2D-23
Section 2D.32	Trailblazer Assembly	2D-23
Section 2D.33	Destination and Distance Signs	2D-24
Section 2D.34	Destination Signs	2D-25
Section 2D.35	Location of Destination Signs	2D-27
Section 2D.36	Distance Signs	2D-28
Section 2D.37	Location of Distance Signs	2D-29
Section 2D.38	Street Name Sign (D3)	2D-29
Section 2D.39	Parking Area Sign (D4-1)	2D-32
Section 2D.40	PARK & RIDE Sign (D4-2)	2D-32
Section 2D.41	Rest Area Signs (D5 Series)	2D-33
Section 2D.42	Scenic Area Signs (D6 Series)	2D-35
Section 2D.43	Weigh Station Signing (D8 Series)	2D-35
Section 2D.44	General Service Signs (D9 Series)	2D-37
Section 2D.45	Reference Posts (D10-1 through D10-3)	2D-41
Section 2D.46	Traffic Signal Speed Sign (I1-1)	2D-43
Section 2D.47	General Information Signs (I Series)	2D-44
Section 2D.48	Signing of Named Highways	2D-47
Section 2D.49	Trail Signs	2D-48
Section 2D.50	Crossover Signs (D13 Series)	2D-49

CHAPTER 2E. GUIDE SIGNS - FREEWAYS AND EXPRESSWAYSDec., 2000

Section 2E.01	Scope of Freeway and Expressway Guide Sign Standards	2E-1
Section 2E.02	Freeway and Expressway Signing Principles.....	2E-1
Section 2E.03	General.....	2E-2
Section 2E.04	Color of Guide Signs.....	2E-2
Section 2E.05	Retroreflectorization or Illumination.....	2E-3
Section 2E.06	Characteristics of Urban Signing.....	2E-3
Section 2E.07	Characteristics of Rural Signing.....	2E-4
Section 2E.08	Memorial Highway Signing.....	2E-5
Section 2E.09	Amount of Legend on Guide Signs.....	2E-5
Section 2E.10	Number of Signs at an Overhead Installation.....	2E-6
Section 2E.11	Sign Spreading and Pull-Through Signs.....	2E-6
Section 2E.12	Designation of Destinations.....	2E-8
Section 2E.13	Size and Style of Letters and Signs.....	2E-9
Section 2E.14	Interline and Edge Spacing.....	2E-17
Section 2E.15	Sign Borders.....	2E-18
Section 2E.16	Abbreviations.....	2E-18
Section 2E.17	Symbols.....	2E-19
Section 2E.18	Arrows for Interchange Guide Signs.....	2E-19
Section 2E.19	Diagrammatic Signs.....	2E-19
Section 2E.20	Signing for Interchange Lane Drops.....	2E-22
Section 2E.21	Changeable Message Signs.....	2E-30
Section 2E.22	Overhead Sign Installations.....	2E-31
Section 2E.23	Lateral Clearance.....	2E-31
Section 2E.24	Guide Sign Classification.....	2E-32
Section 2E.25	Route Signs and Trailblazer Assemblies.....	2E-33
Section 2E.26	Signs for Intersections At Grade.....	2E-35
Section 2E.27	Interchange Guide Signs.....	2E-35
Section 2E.28	Interchange Exit Numbering.....	2E-36
Section 2E.29	Interchange Classification.....	2E-41
Section 2E.30	Advance Guide Signs.....	2E-41
Section 2E.31	Next Exit Supplemental Sign.....	2E-43
Section 2E.32	Other Supplemental Guide Signs.....	2E-44
Section 2E.33	Exit Direction Signs.....	2E-45
Section 2E.34	Exit Gore Signs.....	2E-49
Section 2E.35	Post-Interchange Signs.....	2E-49
Section 2E.36	Distance Signs.....	2E-51
Section 2E.37	Interchange Sequence Signs.....	2E-52
Section 2E.38	Community Interchanges Identification Signs.....	2E-55
Section 2E.39	NEXT X EXITS Sign.....	2E-56
Section 2E.40	Signing by Type of Interchange.....	2E-56
Section 2E.41	Freeway-to-Freeway Interchange.....	2E-57
Section 2E.42	Cloverleaf Interchange.....	2E-59
Section 2E.43	Cloverleaf Interchange with Collector-Distributor Roadways.....	2E-59
Section 2E.44	Partial Cloverleaf Interchange.....	2E-61
Section 2E.45	Diamond Interchange.....	2E-61
Section 2E.46	Urban Diamond Interchange.....	2E-64

Section 2E.47	Closely-Spaced Interchanges.....	2E-66
Section 2E.48	Minor Interchange.....	2E-66
Section 2E.49	Approaches and Connecting Roadways	2E-68
Section 2E.50	Wrong-Way Traffic Control at Interchange Ramps.....	2E-68
Section 2E.51	General Service Signs.....	2E-71
Section 2E.52	Rest and Scenic Area Signs	2E-76
Section 2E.53	Tourist Information and Welcome Centers.....	2E-77
Section 2E.54	Reference Posts.....	2E-79
Section 2E.55	Miscellaneous Guide Signs.....	2E-79
Section 2E.56	Radio Information Signing	2E-80
Section 2E.57	Carpool Information Signing.....	2E-81
Section 2E.58	Weigh Station Signing	2E-82

CHAPTER 2F. SPECIFIC SERVICE SIGNSDec., 2000

Section 2F.01	Eligibility	2F-1
Section 2F.02	Application.....	2F-3
Section 2F.03	Logos and Logo Panels.....	2F-6
Section 2F.04	Number and Size of Logos and Signs	2F-6
Section 2F.05	Size of Lettering.....	2F-7
Section 2F.06	Signs at Interchanges	2F-7
Section 2F.07	Single-Exit Interchanges.....	2F-8
Section 2F.08	Double-Exit Interchanges	2F-8
Section 2F.09	Signs at Intersections	2F-9
Section 2F.10	Signing Policy.....	2F-10

CHAPTER 2G. TOURIST-ORIENTED DIRECTIONAL SIGNS (TODS)Dec., 2000

Section 2G.01	Purpose and Application.....	2G-1
Section 2G.02	Design.....	2G-2
Section 2G.03	Style and Size of Lettering.....	2G-3
Section 2G.04	Arrangement and Size of Signs.....	2G-3
Section 2G.05	Advance Signs.....	2G-6
Section 2G.06	Sign Locations.....	2G-7
Section 2G.07	State Policy.....	2G-7

CHAPTER 2H. RECREATIONAL AND CULTURAL INTEREST AREA SIGNSDec., 2000

Section 2H.01	Scope	2H-1
Section 2H.02	Application of Recreational and Cultural Interest Area Signs.....	2H-1
Section 2H.03	Regulatory and Warning Signs.....	2H-2
Section 2H.04	General Design Requirements for Recreational and Cultural Interest Area Symbol Signs.....	2H-2
Section 2H.05	Symbol Sign Sizes.....	2H-4
Section 2H.06	Use of Educational Plaques.....	2H-4

Section 2H.07 Use of Prohibitive Slash.....2H-4
 Section 2H.08 Placement of Recreational and Cultural Interest Area Symbol Signs 2H-6
 Section 2H.09 Destination Guide Signs.....2H-12

CHAPTER 2I. EMERGENCY MANAGEMENT SIGNINGDec., 2000

Section 2I.01 Emergency Management.....2I-1
 Section 2I.02 Design of Emergency Management Signs.....2I-1
 Section 2I.03 EVACUATION ROUTE Sign (EM-1)2I-2
 Section 2I.04 AREA CLOSED Sign (EM-2).....2I-4
 Section 2I.05 TRAFFIC CONTROL POINT Sign (EM-3)2I-4
 Section 2I.06 MAINTAIN TOP SAFE SPEED Sign (EM-4).....2I-5
 Section 2I.07 ROAD (AREA) USE PERMIT REQUIRED FOR THRU TRAFFIC Sign (EM-5).....2I-5
 Section 2I.08 Emergency Aid Center Signs (EM-6 Series).....2I-6
 Section 2I.09 Shelter Directional Signs (EM-7 Series)2I-6

FIGURES

CHAPTER 2A. GENERAL

Figure 2A-1 Height and Lateral Location of Signs for Typical Installations.....2A-12
 Figure 2A-2 Typical Locations for Signs at Intersections2A-13
 Figure 2A-3 Typical ONE WAY Sign for Divided Highways With Medians Less Than 9 m (30 ft)2A-14
 Figure 2A-4 Typical ONE WAY Sign for Divided Highways With Medians Greater Than 9 m (30 ft)2A-15
 Figure 2A-5 Typical Locations of ONE WAY Signs2A-16
 Figure 2A-6 Typical Locations of ONE WAY Signs2A-17
 Figure 2A-7 Typical Application of Warning Signs2A-18

CHAPTER 2B. REGULATORY SIGNS

Figure 2B-1 Location of Reversible Two-Way Left-Turn Signs2B-25
 Figure 2B-2 Typical Wrong-Way Sign for Divided Highways2B-33

CHAPTER 2D. GUIDE SIGNS - CONVENTIONAL ROADS

Figure 2D-1 Arrows for Use on Guide Signs2D-4
 Figure 2D-2 Illustration of Directional Assemblies and Other Route Signs2D-18
 Figure 2D-3 Typical Weigh Station Signing2D-36

CHAPTER 2E. GUIDE SIGNS - FREEWAYS AND EXPRESSWAYS

Figure 2E-1 Example of Guide Sign Spreading2E-7
 Figure 2E-2 Pull-Through Signs2E-7
 Figure 2E-3 Diagrammatic Sign for Single-Lane Left Exit2E-21

Figure 2E-4 Diagrammatic Signs for Split With Dedicated Lanes2E-23

Figure 2E-5 Diagrammatic Signs for Split With Optional Lane2E-24

Figure 2E-6 Diagrammatic Signs for Two-Lane Exit with Optional Lane and Route
Discontinuity2E-25

Figure 2E-7 Diagrammatic Signs for Two-Lane Exit with Optional Lane2E-26

Figure 2E-8 EXIT 27 ONLY on Left with Diagrammatic Sign for Left
Lane Dropped at Interchange2E-27

Figure 2E-9 EXIT ONLY Panels for Right Lane Dropped at an Interchange.....2E-29

Figure 2E-10 Typical Interchange Numbering for Mainline and Circumferential
Routes2E-38

Figure 2E-11 Typical Interchange Numbering for Mainline, Loop, and Spur
Routes2E-39

Figure 2E-12 Typical Interchange Numbering If Routes Overlap2E-40

Figure 2E-13 Typical Interchange Advance Guide Signs.....2E-42

Figure 2E-14 Next Exit Supplemental Advance Guide Signs2E-44

Figure 2E-15 Supplemental Guide Signs for Multi-Exit Interchanges2E-46

Figure 2E-16 Supplemental Guide Sign for a Park and Ride Facility (Route
without Exit Numbering)2E-46

Figure 2E-17 Supplemental Guide Sign for a Park and Ride Facility (Route
with Exit Numbering)2E-47

Figure 2E-18 Interchange Exit Direction Sign2E-47

Figure 2E-19 Exit Gore Signs2E-50

Figure 2E-20 Post-Interchange Distance Sign2E-51

Figure 2E-21 Signing of Closely-Spaced Interchanges Using Interchange
Sequence Signs2E-53

Figure 2E-22 Interchange Sequence Sign.....2E-54

Figure 2E-23 Community Interchanges Identification Sign.....2E-54

Figure 2E-24 NEXT EXITS Sign2E-54

Figure 2E-25 Typical Freeway-to-Freeway Interchange Guide Signs2E-58

Figure 2E-26 Typical Guide Signs for Full Cloverleaf Interchange2E-60

Figure 2E-27 Typical Partial Cloverleaf Interchange Guide Signs2E-62

Figure 2E-28 Typical Diamond Interchange Guide Signs.....2E-63

Figure 2E-29 Typical Urban Diamond Interchange Guide Signs.....2E-65

Figure 2E-30 Typical Minor Interchange Guide Signs.....2E-67

Figure 2E-31 Typical Regulatory Signing and Pavement Markings at Exit
Ramp Termination to Deter Wrong-Way Entry2E-69

Figure 2E-32 Typical Regulatory Signing and Pavement Markings at
Entrance Ramp Terminal Where Design Does Not Clearly
Indicate the Direction of Flow2E-70

Figure 2E-33 Typical General Service Signs (without Exit Numbering).....2E-72

Figure 2E-34 Typical General Service Signs (with Exit Numbering).....2E-72

Figure 2E-35 Typical Next Services Sign.....2E-72

Figure 2E-36 Typical Rest Area Gore Sign2E-72

CHAPTER 2F. SPECIFIC SERVICE SIGNS

Figure 2F-1 Typical Specific Service Signs.....2F-4

Figure 2F-2 Typical Specific Service Sign Locations2F-5

CHAPTER 2G. TOURIST-ORIENTED DIRECTIONAL SIGNS

Figure 2G-1	Typical Tourist-Oriented Directional Signs	2G-4
Figure 2G-2	Typical Intersection Approach Signs and Advance Signs for Tourist-Oriented Directional Signs	2G-5

**CHAPTER 2H. RECREATIONAL AND CULTURAL INTEREST
AREA SIGNS**

Figure 2H-1	Typical Use of Educational Plaques, Prohibitory Slashes, and Arrows	2H-5
Figure 2H-2	Typical General Directional Guide Signs for Conventional Roads	2H-7
Figure 2H-3	Height and Lateral Position of Signs Located Within Recreational and Cultural Interest Areas	2H-8
Figure 2H-4	Typical Symbol Signing Layout.....	2H-9
Figure 2H-5	Modifications to Existing Symbols	2H-10
Figure 2H-6	New Recreational and Cultural Interest Area Symbols	2H-11

TABLES**CHAPTER 2A. GENERAL**

Table 2A-1	Illumination of Sign Elements	2A-6
Table 2A-2	Retroreflection of Sign Elements	2A-6
Table 2A-3	Use of Sign Shapes.....	2A-7
Table 2A-4	Common Uses of Sign Colors.....	2A-9

CHAPTER 2B. REGULATORY SIGNS

Table 2B-1	Regulatory Sign Sizes.....	2B-2
Table 2B-2	Meanings of Symbols and Legends on Reversible Lane Control Signs	2B-26

CHAPTER 2C. WARNING SIGNS

Table 2C-1	Application of Warning Signs	2C-2
Table 2C-2	Warning Sign Sizes.....	2C-4
Table 2C-3	Minimum Size of Supplemental Warning Plaques.....	2C-5
Table 2C-4	Guidelines for Advance Placement of Warning Signs	2C-6
Table 2C-5	Horizontal Alignment Sign Usage.....	2C-10

CHAPTER 2E. GUIDE SIGNS - FREEWAYS AND EXPRESSWAYS

Table 2E-1	Minimum Letter and Numeral Sizes for Expressway Guide Signs According to Interchange Classification	2E-10
------------	--	-------

Table 2E-2	Minimum Letter and Numeral Sizes for Expressway Guide Signs According to Sign Type	2E-12
Table 2E-3	Minimum Letter and Numeral Sizes for Freeway Guide Signs According to Interchange Classification	2E-14
Table 2E-4	Minimum Letter and Numeral Sizes for Freeway Guide Signs According to Sign Type	2E-16

**CHAPTER 2H. RECREATIONAL AND CULTURAL INTEREST
AREA SIGNS**

Table 2H-1	Category Chart for Symbols.....	2H-3
------------	---------------------------------	------

CHAPTER 2A. GENERAL

Section 2A.01 Function and Purpose of Signs

Support:

This Manual contains Standards, Guidance, and Options for the signing within the right-of-way of all types of highways open to public travel. The functions of signs are to provide regulations, warnings, and guidance information for road users. Both words and symbols are used to convey the messages. Signs are not typically used to confirm rules of the road.

Detailed sign requirements are located in the following Chapters of Part 2:

- Chapter 2B – Regulatory Signs
- Chapter 2C – Warning Signs
- Chapter 2D – Guide Signs (Conventional Roads)
- Chapter 2E – Guide Signs (Freeways and Expressways)
- Chapter 2F – Specific Service (Logo) Signs
- Chapter 2G – Tourist-Oriented Direction Signs
- Chapter 2H – Recreational and Cultural Interest Area Signs
- Chapter 2I – Emergency Management Signs

Standard:

Because the requirements and standards for signs depend on the particular type of highway upon which they are to be used, the following definitions shall apply:

- A. Freeway - a divided highway with full control of access.**
- B. Expressway - a divided highway with partial control of access.**
- C. Conventional Road - a street or highway other than a low-volume road (as defined in Section 5A.01), a freeway, or an expressway.**
- D. Special Purpose Road - a low-volume, low-speed road that serves recreational areas or resource development activities, or that provides local access.**

Section 2A.02 Definitions

Support:

Definitions that are applicable to signs are given in Sections 1A.13 and 2A.01.

Section 2A.03 Standardization of Application

Support:

It is recognized that urban traffic conditions differ from those in rural environments, and in many instances signs are applied and located differently. Where pertinent and practical, this Manual sets forth separate recommendations for urban and rural conditions.

Guidance:

Signs should be used only where justified by engineering judgment or studies, as noted in Section 1A.09.

Results from traffic engineering studies of physical and traffic factors should indicate the locations where signs are deemed necessary or desirable.

Roadway geometric design and sign application should be coordinated so that signing can be effectively placed to give the road user any necessary regulatory, warning, guidance, and other information.

Standard:

Each standard sign shall be displayed only for the specific purpose as prescribed in this Manual. Determination of the particular signs to be applied to a specific condition shall be made in accordance with the criteria set forth in Part 2. Before any new highway, detour, or temporary route is opened to traffic, all necessary signs shall be in place. Signs required by road conditions or restrictions shall be removed when those conditions cease to exist or the restrictions are withdrawn.

Section 2A.04 Excessive Use of Signs

Guidance:

Regulatory and warning signs should be used conservatively because these signs, if used to excess, tend to lose their effectiveness. If used, route signs and directional signs should be used frequently because they promote safe and efficient operations by keeping road users informed of their location.

Section 2A.05 Classification of Signs**Standard:**

Signs shall be defined by their function as follows:

- A. Regulatory signs give notice of traffic laws or regulations.**
- B. Warning signs give notice of a situation that might not be readily apparent.**
- C. Guide signs show route designations, destinations, directions, distances, services, points of interest, and other geographical, recreational, or cultural information.**

Section 2A.06 Design of Signs**Support:**

This Manual shows many typical standard signs approved for use on streets, highways, bikeways, and pedestrian crossings.

In the specifications for individual signs, the legend, color, and size are shown in the accompanying tables and illustrations, and are not always detailed in the text.

Detailed drawings of standard signs and alphabets are shown in the "Standard Highway Signs" book, and in the "Standard Alphabets for Highway Signs and Pavement Markings." Section 1A.11 contains information regarding how to obtain these publications.

The basic requirements of a highway sign are that it be legible to those for whom it is intended and that it be understandable in time to permit a proper response. Desirable attributes include:

- A. High visibility by day and night, and
- B. High legibility (adequately sized letters or symbols, and a short legend for quick comprehension by a road user approaching a sign).

Standardized colors and shapes are specified so that the several classes of traffic signs can be promptly recognized. Simplicity and uniformity in design, position, and application are important.

Standard:

The term legend shall include all word messages and symbol designs that are intended to convey specific meanings.

Uniformity in design shall include shape, color, dimensions, legends, borders, and illumination or retroreflectivity.

Where a word message is applicable, the wording shall be as herein provided. Standardization of these designs does not preclude further improvement by minor changes in the proportion or orientation of symbols, width of borders, or layout of word messages, but all shapes and colors shall be as indicated.

In situations where word messages are required other than those herein provided, the signs shall be of the same shape and color as standard signs of the same functional type.

Option:

State and local highway agencies may develop special word message signs in situations where roadway conditions make it necessary to provide road users with additional regulatory, warning, or guidance information.

Section 2A.07 Changeable Message Signs

Standard:

Changeable message signs, which are traffic control devices designed to display variable messages, shall conform to the principles established in this Manual, and to the extent practical, with the design and applications prescribed in Sections 6F.02 and 6F.55.

Guidance:

Changeable message signs should not be used to display information other than regulatory, warning, and guidance information related to traffic control.

Support:

Changeable message signs, with more sophisticated technologies, are gaining widespread use to inform road users of variable situations, particularly along congested traffic corridors. Highway and transportation organizations are encouraged to develop and experiment (see Section 1A.10) with changeable message signs and to carefully evaluate such installations so that additional standards may be adopted in the future.

Information regarding the design and application of portable changeable message signs in temporary traffic control zones is contained in Section 6F.02.

Section 2A.08 Retroreflectivity and Illumination**Support:**

There are many materials currently available for retroreflection and various methods currently available for the illumination of signs. New materials and methods continue to emerge. New materials and methods can be used as long as the signs meet the standard requirements for color, both by day and night.

Standard:

Regulatory, warning, and guide signs shall be retroreflective or illuminated to show the same shape and similar color by both day and night, unless specifically stated otherwise in the text discussion in this Manual of a particular sign or group of signs.

The requirements for sign illumination shall not be considered to be satisfied by street, highway, or strobe lighting.

Guidance:

All overhead sign installations should be illuminated unless an engineering study shows that retroreflection will perform effectively without illumination.

Option:

Different sign elements may be illuminated by the means shown in Table 2A-1.

Retroreflection of different sign elements may be by the means shown in Table 2A-2.

Section 2A.09 Minimum Retroreflectivity Levels**Support:**

(This section is reserved for future text based on FHWA rulemaking.)

Section 2A.10 Shapes**Standard:**

Particular shapes, as shown in Table 2A-3, shall be used exclusively for specific signs or series of signs, unless specifically stated otherwise in the text discussion in this Manual for a particular sign or class of signs.

Table 2A-1. Illumination of Sign Elements

Means of Illumination	Sign Element to be Illuminated
Light behind the sign face	<ul style="list-style-type: none"> • Symbol or message • Background • Symbol, message, and background (through a translucent material)
Attached or independently-mounted light source designed to direct essentially uniform illumination onto the sign face	<ul style="list-style-type: none"> • Entire sign face
<p>Other devices, or treatments that highlight the sign shape, color, or message at night:</p> <p>Luminous tubing</p> <p>Fiber optics (shaped to the lettering or symbol)</p> <p>Patterns of incandescent light bulbs</p> <p>Luminescent panels</p>	<ul style="list-style-type: none"> • Symbol or message • Entire sign face

Table 2A-2. Retroreflection of Sign Elements

Means of Retroreflection	Sign Element
Reflector "buttons" or similar units	<p>Symbol</p> <p>Word message</p> <p>Border</p>
A material that has a smooth, sealed outer surface over a microstructure that reflects light	<p>Symbol</p> <p>Word message</p> <p>Border</p> <p>Background</p>

Table 2A-3. Use of Sign Shapes

Shape	Signs
Octagon	* Stop
Equilateral Triangle (1 point down)	* Yield
Circle	Highway-Rail Grade Crossing (Advance Warning) Emergency Evacuation Route Marker
Pennant Shape / Isosceles Triangle (longer axis horizontal)	* No Passing
Pentagon (pointed up)	* School Crossing Series * County Route Sign
Crossbuck (two rectangles in an "X" configuration)	* Highway-Rail Grade Crossing
Diamond	Warning Series
Rectangle	Regulatory Series ** Guide Series Warning Series
Trapezoid	* Recreational Series

* Indicates exclusive use

** Guide series includes general service, specific service, and recreation signs

Section 2A.11 Sign Colors

Standard:

The colors to be used on standard signs and their specific use on these signs shall be as indicated in the specific Sections of Part 2. The color coordinates and values shall be as described in the "Standard Highway Signs" book.

Support:

As a quick reference, common uses of sign colors are shown in Table 2A-4. Color schemes on specific signs are shown in the illustrations located in each appropriate Section.

Whenever white is specified herein as a color, it is understood to include silver-colored retroreflective coatings or elements that reflect white light.

The colors purple, light blue, and coral are being reserved for uses that will be determined in the future by the Federal Highway Administration.

Section 2A.12 Dimensions

Support:

Sign sizes for use on the different classes of highways are shown in Sections 2B.03 and 2C.04 and in the "Standard Highway Signs" book.

Standard:

The standard sign dimensions prescribed in this Manual and in the "Standard Highway Signs" book shall be used unless engineering judgment determines that other sizes are appropriate. Where engineering judgment determines that sizes smaller than the standard dimensions are appropriate for use, the sign dimensions shall not be less than the minimum dimensions specified in this Manual and in the "Standard Highway Signs" book. Where engineering judgment determines that sizes larger than the standard dimensions are appropriate for use, standard shapes and colors shall be used and standard proportions shall be retained as much as practical.

Guidance:

Increases above standard sizes should be used where greater legibility or emphasis is needed. Wherever practical, the overall sign dimensions should be increased in 150 mm (6 in) increments.

Table 2A-4. Common Uses of Sign Colors

Type of Sign	Legend					Background								
	Black	Green	Red	White	Yellow	Black	Blue	Brown	Green	Orange	Red	White	Yellow	FYG*
Regulatory	X		X	X		X					X	X		
Prohibitive			X	X							X	X		
Permissive		X										X		
Warning	X												X	
Pedestrian	X												X	X
Bicycle	X												X	X
Guide				X					X					
Interstate Route				X			X				X			
State Route	X											X		
US Route	X											X		
County Route					X		X							
Forest Route				X				X						
Evacuation Route				X			X							
Information				X			X		X					
Milepost Signs				X					X					
Road User Service				X			X							
Recreational				X				X	X					
Street Name				X					X					
Destination				X					X					
Temporary Traffic Control	X									X				
School	X												X	X

*FYG is fluorescent yellow-green

Section 2A.13 Symbols

Support:

Sometimes a change from word messages to symbols requires significant time for public education and transition. Therefore, this Manual includes the practice of using educational plaques to accompany some new symbol signs.

Standard:

Symbol designs shall in all cases be unmistakably similar to those shown in this Manual and the "Standard Highway Signs" book. New symbol designs shall be adopted by the Federal Highway Administration based on research evaluations to determine road user comprehension, sign conspicuity, and sign legibility.

Guidance:

New warning or regulatory symbol signs not readily recognizable by the public should be accompanied by an educational plaque.

Option:

State and/or local highway agencies may conduct research studies to determine road user comprehension, sign conspicuity, and sign legibility.

Educational plaques may be left in place as long as they are in serviceable condition.

Although most standard symbols are oriented facing left, mirror images of these symbols may be used where the reverse orientation might better convey to road users a direction of movement.

Section 2A.14 Word Messages

Standard:

Except as noted in Section 2A.06, all word messages shall use standard wording and letters as shown in this Manual, the "Standard Highway Signs" book, and the "Standard Alphabets for Highway Signs and Pavement Markings."

Guidance:

Word messages should be as brief as possible and the lettering should be large enough to provide the necessary legibility distance. A specific ratio, such as 25 mm (1 in) of letter height per 12 m (40 ft) of legibility distance, should be used.

Abbreviations (see Section 1A.14) should be kept to a minimum, and should include only those that are commonly recognized and understood, such as AVE (for Avenue), BLVD (for Boulevard), N (for North), or JCT (for Junction).

Standard:

All sign lettering shall be in capital letters as provided in the "Standard Alphabets for Highway Signs and Pavement Markings," except as indicated in the Option below.

Option:

Word messages on street name signs and destinations on guide signs may be composed of a combination of lower-case letters with initial upper-case letters.

Section 2A.15 Sign Borders

Standard:

Unless specifically stated otherwise, each sign illustrated herein shall have a border of the same color as the legend, at or just inside the edge.

The corners of the sign panel and border shall be rounded, except for STOP signs.

Guidance:

A dark border on a light background should be set in from the edge, while a light border on a dark background should extend to the edge of the panel. A border for 750 mm (30 in) signs with a light background should be from 13 to 19 mm (0.5 to 0.75 in) in width, 13 mm (0.5 in) from the edge. For similar signs with a light border, a width of 25 mm (1 in) should be used. For other sizes, the border width should be of similar proportions, but should not exceed the stroke-width of the major lettering of the sign. On signs exceeding 1800 x 3000 mm (72 x 120 in) in size, the border should be 50 mm (2 in) wide, or on larger signs, 75 mm (3 in) wide.

Section 2A.16 Standardization of Location

Support:

Standardization of position cannot always be attained in practice. Locations for a number of typical signs are illustrated in Figures 2A-1 to 2A-7.

Figure 2A-1. Height and Lateral Location of Signs for Typical Installations

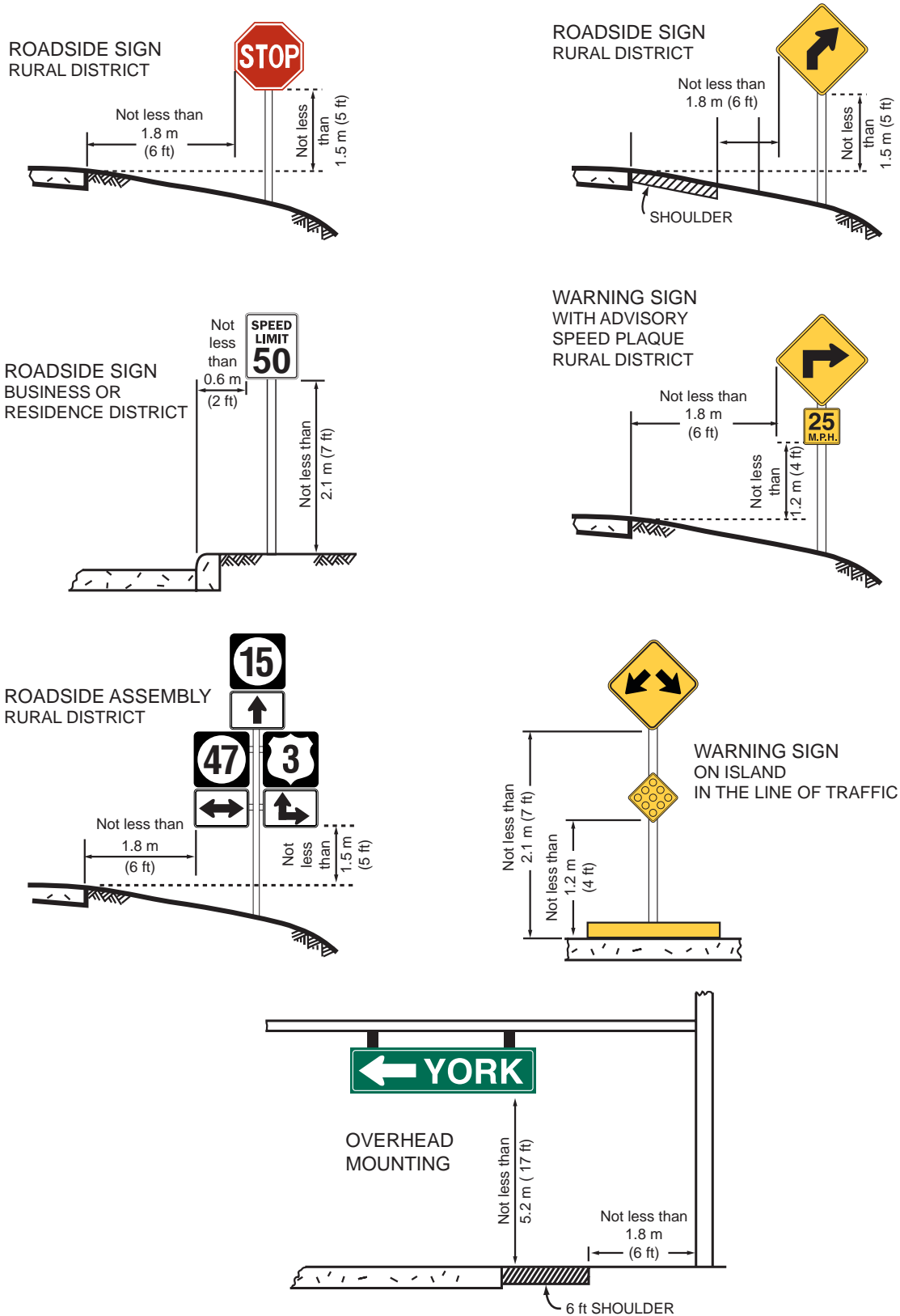

Figure 2A-2. Typical Locations for Signs at Intersections

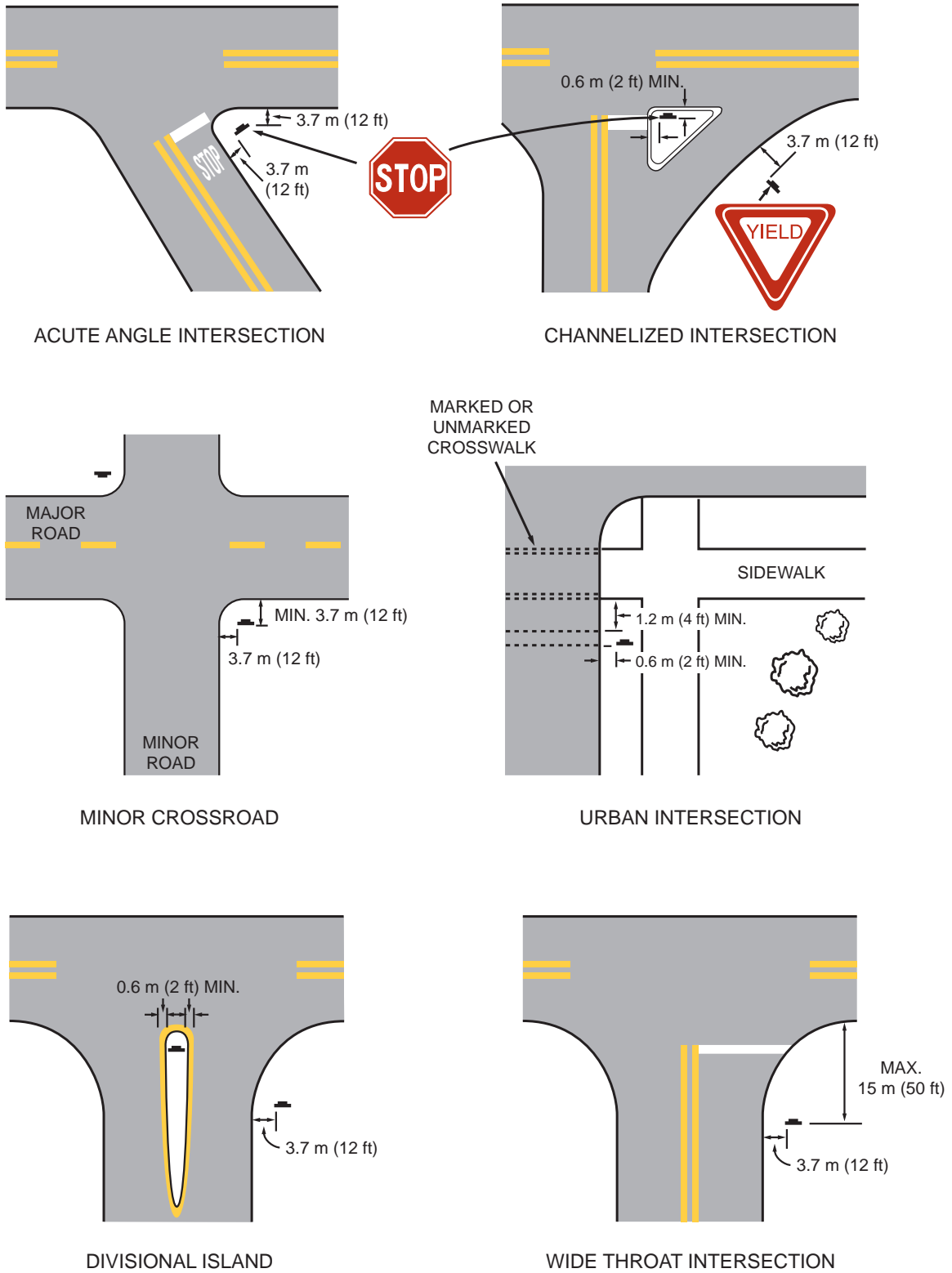
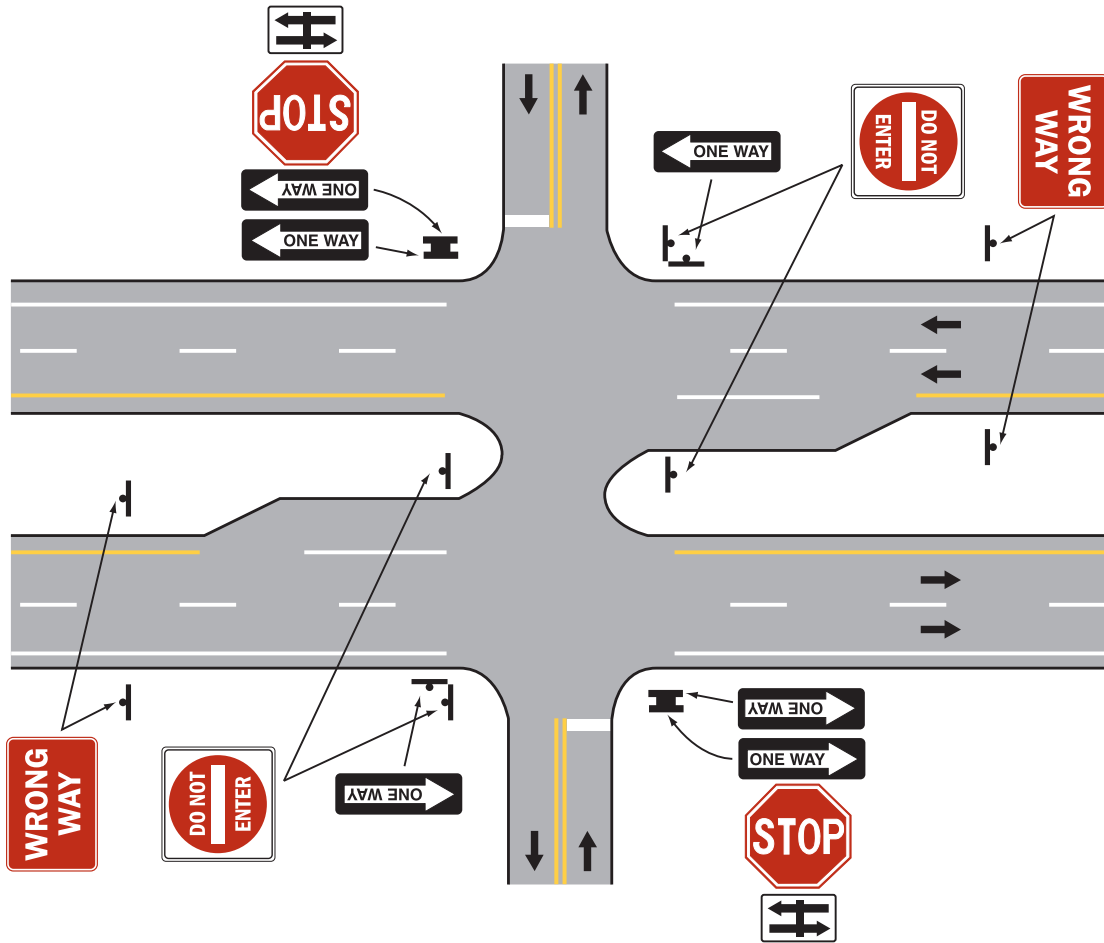

Figure 2A-3. Typical ONE WAY Signing for Divided Highways with Medians Less Than 9 m (30 ft)



Note: All signs shown are optional except the STOP signs

Legend

→ Direction of travel



Typical Mounting

Figure 2A-4. Typical ONE WAY Signing for Divided Highways with Medians Greater Than 9 m (30 ft)

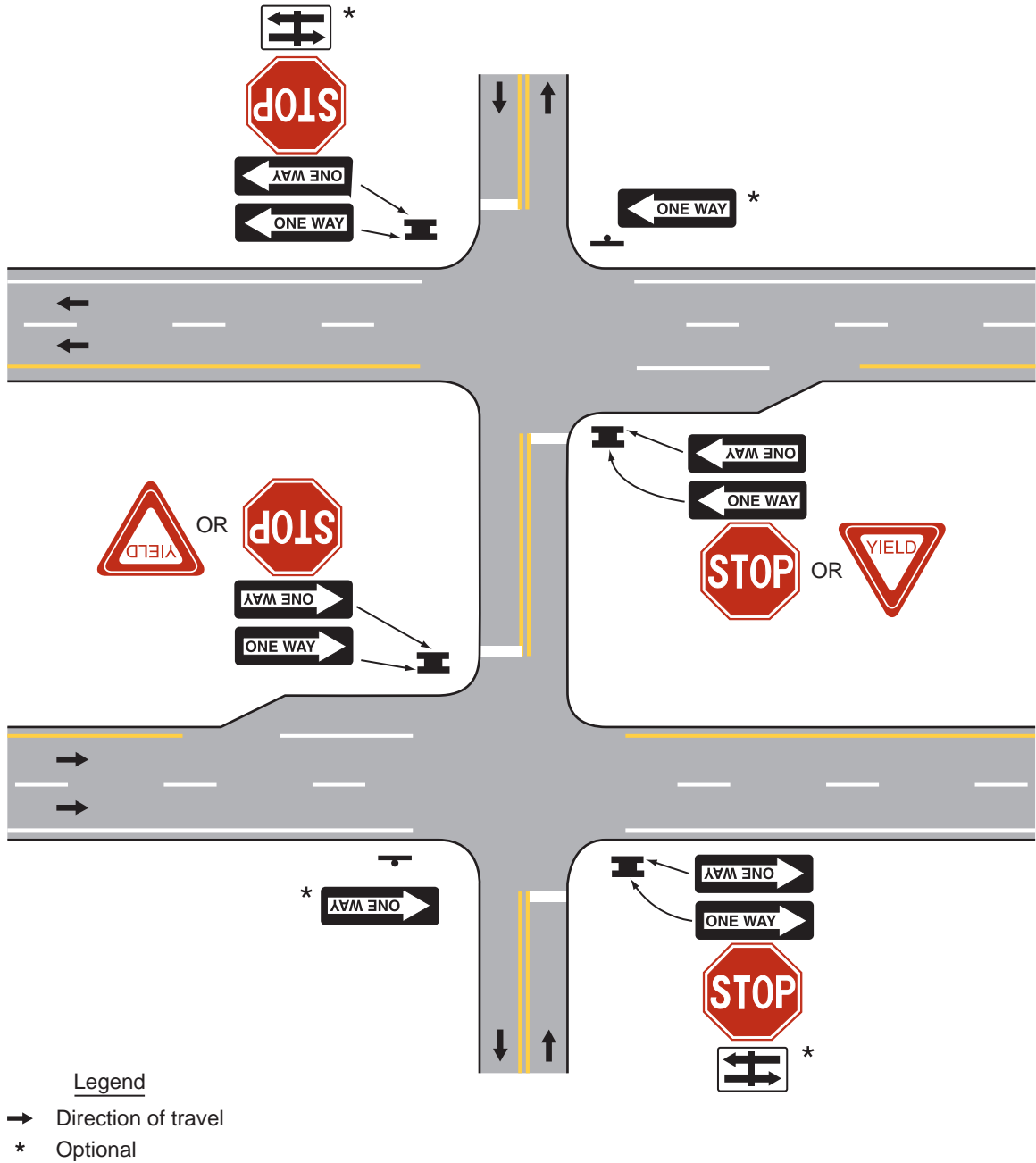
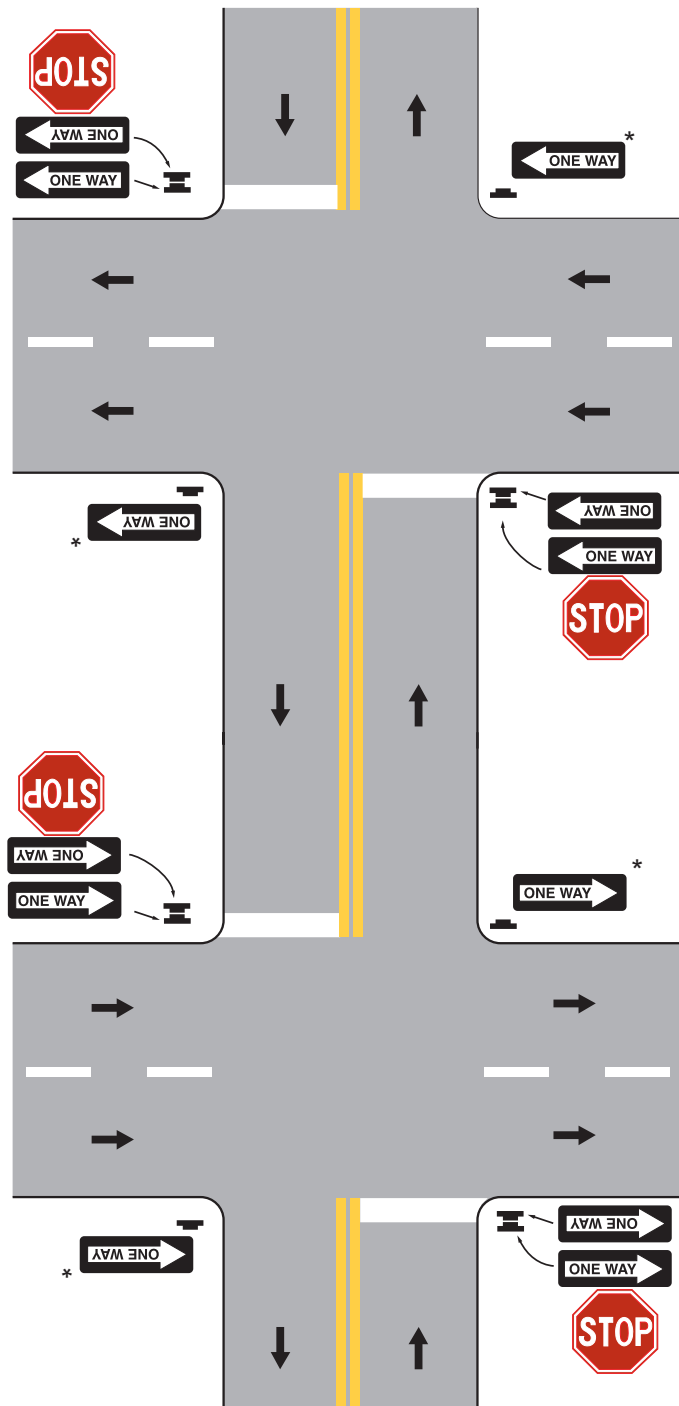
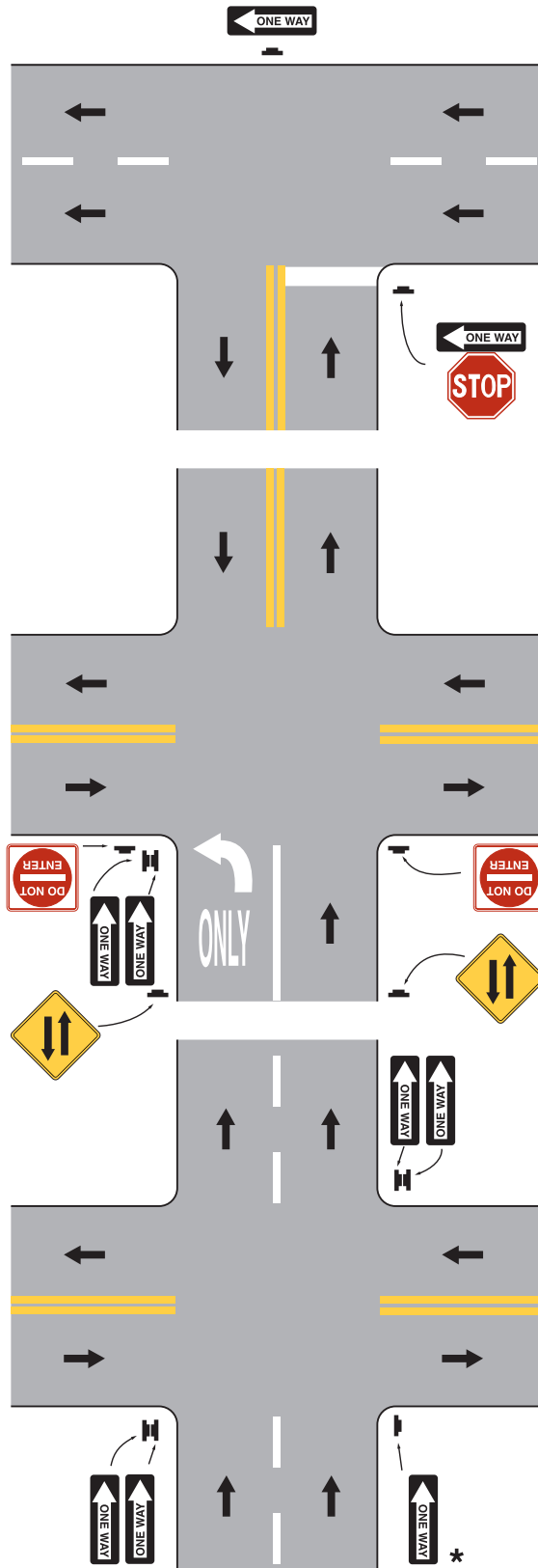

Figure 2A-5. Typical Locations of ONE WAY Signs



- Legend
- Direction of travel
 - * Optional

Figure 2A-6. Typical Locations of ONE WAY Signs



- Legend
- Direction of travel
 - * Optional

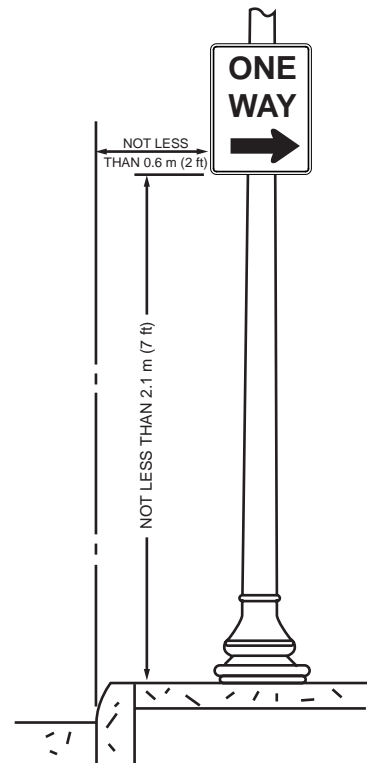
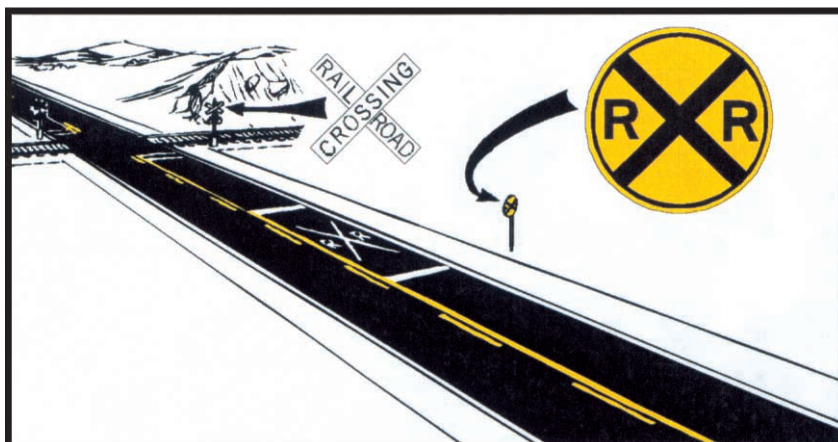
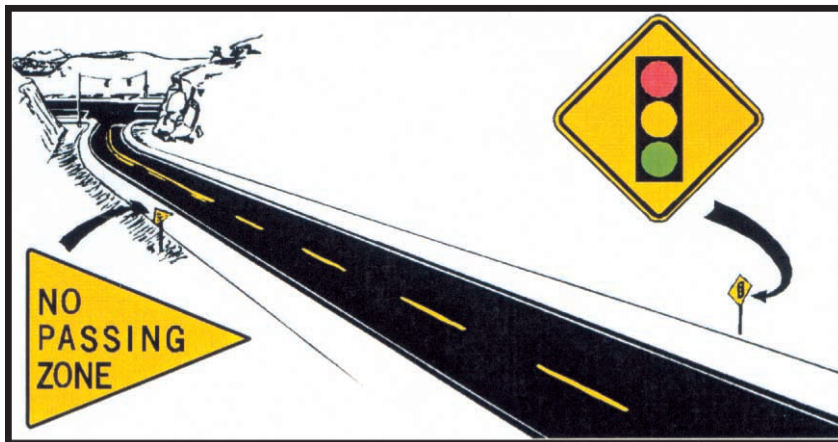
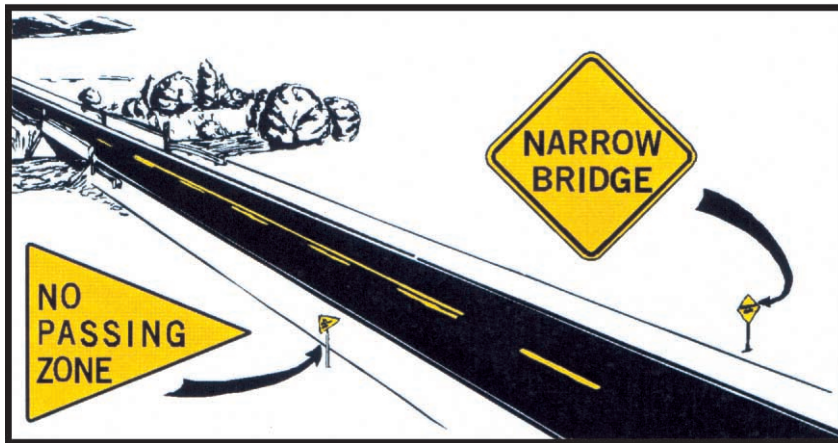

Figure 2A-7. Typical Applications of Warning Signs



Standard:

Signs requiring different decisions by the road user shall be spaced sufficiently far apart for the required decisions to be made safely. One of the factors considered when determining the appropriate spacing shall be the posted or 85th-percentile speed.

Guidance:

Signs should be located on the right side of the roadway where they are easily recognized and understood by road users. Signs in other locations should be considered only as supplementary to signs in the normal locations, except as otherwise indicated.

Signs should be individually installed on separate posts or mountings except where one sign supplements another or where route or directional signs must be grouped. Signs should be located so that they:

- A. Are outside the clear zone unless placed on a breakaway or yielding support (see Section 2A.19);
- B. Optimize nighttime visibility;
- C. Minimize the effects of mud splatter and debris;
- D. Do not obscure each other; and
- E. Are not hidden from view.

Support:

The clear zone is the total roadside border area, starting at the edge of the traveled way, available for use by errant vehicles. The desired width is dependent upon traffic volumes, speeds, and roadside geometry. Additional information can be found in the "AASHTO Roadside Design Guide" (see Page i for AASHTO's address).

Guidance:

With the increase in traffic volumes and the desire to provide road users regulatory, warning, and guidance information, an order of priority for sign installation should be established.

Support:

An order of priority is especially critical where space is limited for sign installation and there is a demand for several different types of signs. Overloading road users with too much information is not desirable.

Guidance:

Because regulatory and warning information is more critical to the road user than guidance information, regulatory and warning signing whose location is critical should be displayed rather than guide signing in cases where conflicts occur. Information of a less critical nature should be moved to less critical locations or omitted.

Option:

Under some circumstances, such as on curves to the right, signs may be placed on median islands or on the left side of the road. A supplementary sign located on the left of the roadway may be used on a multi-lane road where traffic in the right lane might obstruct the view to the right.

Guidance:

In urban areas where crosswalks exist, signs should not be placed within 1.2 m (4 ft) in advance of the crosswalk.

Section 2A.17 Overhead Sign Installations**Guidance:**

Overhead signs should be used on expressways, where some degree of lane-use control is desirable, or where space is not available at the roadside.

Support:

The operational requirements of the present highway system are such that overhead signs have value at many locations. The factors to be considered for the installation of overhead sign displays are not definable in specific numerical terms.

Option:

The following conditions (not in priority order) may be considered in an engineering study to determine if overhead signs should be used:

- A. Traffic volume at or near capacity
- B. Complex interchange design
- C. Three or more lanes in each direction
- D. Restricted sight distance
- E. Closely-spaced interchanges

- F. Multi-lane exits
- G. Large percentage of trucks
- H. Street lighting background
- I. High-speed traffic
- J. Consistency of sign message location through a series of interchanges
- K. Insufficient space for ground-mounted signs
- L. Junction of two freeways
- M. Left exit ramps

Over-crossing structures may serve for the support of overhead signs, and under some circumstances, may be the only practical solution that will provide adequate viewing distance. Use of such structures as sign supports may eliminate the need for the foundations and sign supports along the roadside.

On freeways and expressways, signs may be placed on bridges, where feasible, to enhance safety and economy.

Section 2A.18 Mounting Height

Standard:

Signs installed at the side of the road in rural districts shall be at least 1.5 m (5 ft), measured from the bottom of the sign to the near edge of the pavement. Where parking or pedestrian movements occur, the clearance to the bottom of the sign shall be at least 2.1 m (7 ft).

Directional signs on expressways and freeways shall be installed with a minimum height of 2.1 m (7 ft). If a secondary sign is mounted below another sign, the major sign shall be installed at least 2.4 m (8 ft) and the secondary sign at least 1.5 m (5 ft) above the level of the pavement edge. All route signs, warning signs, and regulatory signs on expressways and freeways shall be at least 2.1 m (7 ft) above the level of the pavement edge.

Overhead signs shall provide a vertical clearance of not less than 5.1 m (17 ft) to the sign, light fixture, or sign bridge, over the entire width of the pavement and shoulders except where a lesser vertical clearance is used for the design of other structures. The vertical clearance to overhead sign structures or supports shall not be greater than 0.3 m (1 ft) in excess of the minimum clearance of other structures.

Option:

The height to the bottom of a secondary sign mounted below another sign may be 0.3 m (1 ft) less than the height specified above.

Where signs are placed 9 m (30 ft) or more from the edge of the traveled way, the height to the bottom of such signs may be 1.5 m (5 ft) above the level of the pavement edge.

A route sign assembly consisting of a route sign and auxiliary signs (see Section 2D.27) may be treated as a single sign for the purposes of this section.

The mounting height may be adjusted when supports are located near the edge of the right-of-way on a steep backslope.

Support:

Without this flexibility regarding steep backslopes, some agencies might decide to relocate the sign closer to the road, which might be less desirable.

Option:

In special cases it may be necessary to reduce the clearance to overhead signs because of substandard dimensions in tunnels and other major structures such as double-deck bridges.

Support:

Figure 2A-1 illustrates some of the mounting height requirements contained in this Section.

Section 2A.19 Lateral Offset**Standard:**

The minimum lateral offset from the edge of the shoulder (or if no shoulder exists, from the edge of the pavement) to the near edge of a roadside-mounted sign shall be 1.8 m (6 ft). Roadside-mounted sign supports shall be breakaway, yielding, or shielded with a longitudinal barrier or crash cushion if within the clear zone.

The minimum lateral offset from the edge of the shoulder (or if no shoulder exists, from the edge of the pavement) to the near edge of overhead sign supports (cantilever or sign bridges) shall be 1.8 m (6 ft). Overhead sign supports shall have a barrier or crash cushion to shield them if they are within the clear zone.

Support:

The minimum lateral offset is intended to keep trucks and cars that use the shoulders from striking the signs or supports. The minimum lateral offset is only a small portion of the clear zone available for the use of errant vehicles.

Guidance:

All supports should be located as far as practical from the edge of the shoulder. Advantage should be taken to place signs behind existing roadside barriers, on over-crossing structures, or other locations that minimize the exposure of the traffic to sign supports.

Option:

Where permitted, signs may be placed on existing supports used for other purposes, such as traffic signal supports, highway lighting supports, and utility poles.

Standard:

If signs are placed on existing supports, they shall meet other placement criteria contained in this Manual.

Option:

Lesser lateral offsets may be used on connecting roadways or ramps at interchanges, but not less than 1.8 m (6 ft) from the edge of the traveled way.

In urban areas where lateral offsets are limited, a minimum lateral offset of 0.6 m (2 ft) may be used.

A minimum offset of 0.3 m (1 ft) from the face of the curb may be used in urban areas where sidewalk width is limited or where existing poles are close to the curb.

Support:

Figure 2A-1 illustrates some of the lateral offset requirements contained in this Section.

Section 2A.20 Position of Signs**Support:**

Detailed specifications for sign locations are given in other Sections of this Manual dealing with an individual sign or class of signs.

Figures 2A-2 through 2A-7 show typical placements of signs.

Section 2A.21 Orientation

Guidance:

Signs should be vertically-mounted at right angles to the direction of, and facing, the traffic that they are intended to serve.

Where mirror reflection from the sign face is encountered to such a degree as to reduce legibility, the sign should be turned slightly away from the road. Signs that are placed 9 m (30 ft) or more from the pavement edge should be turned toward the road. On curved alignments, the angle of placement should be determined by the direction of approaching traffic rather than by the roadway edge at the point where the sign is located.

Option:

On grades, sign faces may be tilted forward or back from the vertical position to improve the viewing angle.

Section 2A.22 Posts and Mountings

Standard:

Sign posts, foundations, and mountings shall be so constructed as to hold signs in a proper and permanent position, and to resist swaying in the wind or displacement by vandalism.

Support:

The latest edition of AASHTO's "Specifications for Structural Supports for Highway Signs, Luminaires, and Traffic Signals" contains additional information regarding posts and mounting (see Page i for AASHTO's address).

Section 2A.23 Maintenance

Guidance:

All traffic signs should be kept in proper position, clean, legible, and with adequate retroreflectivity. Damaged or deteriorated signs should be replaced.

To assure adequate maintenance, a schedule for inspecting (both day and night), cleaning, and replacing signs should be established. Employees of highway agencies, police, and other public agencies whose duties require that they travel on the roadways

should be encouraged to report any damaged, deteriorated, or obscured signs at the first opportunity.

Steps should be taken to see that weeds, trees, shrubbery, and construction, maintenance, and utility materials and equipment do not obscure the face of any sign.

A regular schedule of replacement of lighting elements for illuminated signs should be maintained.

Section 2A.24 Wrong-Way Traffic Control

Standard:

Where divided highways are separated by median widths of 9 m (30 ft) or more, the intersections with crossroads shall be signed as two separate intersections.

Guidance:

Engineering studies should be conducted to identify and suggest practical corrections at intersections on divided highways where wrong-way usage is being experienced or where a wide median, a rural unlighted environment, or other contributing factors indicate the likelihood of wrong-way movements.

If used, DO NOT ENTER signs should be placed on divided highways at locations directly in view of a driver making a wrong-way entry from the crossroad, and WRONG WAY signs should be placed further from the crossroad than the DO NOT ENTER signs (see Figure 2A-3).

CHAPTER 2B. REGULATORY SIGNS

Section 2B.01 Application of Regulatory Signs

Standard:

Regulatory signs shall be used to inform road users of selected traffic laws or regulations and indicate the applicability of the legal requirements.

Regulatory signs shall be installed at or near where the regulations apply. The signs shall clearly indicate the requirements imposed by the regulations and shall be designed and installed to provide adequate visibility and legibility in order to obtain compliance.

Regulatory signs shall be retroreflective or illuminated to show the same shape and similar color by both day and night, unless specifically stated otherwise in the text discussion of a particular sign or group of signs (see Section 2A.08).

The requirements for sign illumination shall not be considered to be satisfied by street, highway, or strobe lighting.

Section 2B.02 Design of Regulatory Signs

Support:

Most regulatory signs are rectangular, with the longer dimension vertical. The shapes and colors of regulatory signs are listed in Tables 2A-3 and 2A-4, respectively. Exceptions are specifically noted in the following Sections.

The use of educational plaques to supplement symbol signs is described in Section 2A.13.

Section 2B.03 Size of Regulatory Signs

Support:

The "Standard Highway Signs" book contains sign sizes and letter heights for regulatory signs used on conventional roads, expressways, freeways, low-volume roads, and under special conditions.

Standard:

The sizes for regulatory signs shall be as shown in Table 2B-1.

Table 2B-1. Regulatory Sign Sizes (Sheet 1 of 4)

Sign	MUTCD Code	Section	Conventional Roads	Expressways	Freeways	Minimum	Oversized
Stop	R1-1	2B.04	750 x 750 (30 x 30)	900 x 900 (36 x 36)	—	600 x 600 (24 x 24)	1200 x 1200 (48 x 48)
Yield	R1-2	2B.08	900 x 900 x 900 (36 x 36 x 36)	1200 x 1200 x 1200 (48 x 48 x 48)	1500 x 1500 x 1500 (60 x 60 x 60)	750 x 750 x 750 (30 x 30 x 30)	—
4-Way	R1-3	2B.04	300 x 150 (12 x 6)	—	—	—	—
All Way	R1-4	2B.04	450 x 150 (18 x 6)	—	—	—	—
Speed Limit	R2-1	2B.11	600 x 750 (24 x 30)	900 x 1200 (36 x 48)	1200 x 1500 (48 x 60)	—	—
Truck Speed Limit	R2-2	2B.12	600 x 600 (24 x 24)	900 x 900 (36 x 36)	1200 x 1200 (48 x 48)	—	—
Night Speed Limit	R2-3	2B.13	600 x 600 (24 x 24)	900 x 900 (36 x 36)	1200 x 1200 (48 x 48)	—	—
Minimum Speed Limit	R2-4	2B.14	600 x 750 (24 x 30)	900 x 1200 (36 x 48)	1200 x 1500 (48 x 60)	—	—
Combined Speed Limit	R2-4a	2B.14	600 x 1200 (24 x 48)	900 x 1800 (36 x 72)	1200 x 2400 (48 x 96)	—	—
Reduced Speed Ahead	R2-5 series	2B.16	600 x 750 (24 x 30)	—	—	—	—
Turn Prohibition	R3-1,2,3,4	2B.17	600 x 600 (24 x 24)	900 x 900 (36 x 36)	—	—	1200 x 1200 (48 x 48)
Mandatory Movement Lane Control	R3-5 series	2B.19	750 x 900 (30 x 36)	—	—	—	—
Optional Movement Lane Control	R3-6	2B.20	750 x 900 (30 x 36)	—	—	—	—
Mandatory Movement Lane Control	R3-7	2B.19	750 x 750 (30 x 30)	—	—	—	—
Advance Intersection Lane Control	R3-8,8a,8b	2B.21	variable x 750 (variable x 30)	—	—	—	—
Two-Way Left Turn Only (overhead mounted)	R3-9a	2B.22	750 x 900 (30 x 36)	—	—	—	—
Two-Way Left Turn Only (ground mounted)	R3-9b	2B.22	600 x 900 (24 x 36)	—	—	—	900 x 1200 (36 x 48)
Reversible Lane Control (symbol)	R3-9c,9d	2B.23	2700 x 1200 (108 x 48)	—	—	—	—
Reversible Lane Control	R3-9e	2B.23	3000 x 1500 (120 x 60)	—	—	—	—
Reversible Lane Control (ground mounted)	R3-9f	2B.23	750 x 1050 (30 x 42)	—	—	—	—
Advance Reversible Lane Control Transition Signing	R3-9g,9h	2B.23	2700 x 900 (108 x 36)	—	—	—	—
End Reverse Lane	R3-9i	2B.23	2700 x 1200 (108 x 48)	—	—	—	—
HOV 2+ Lane Ahead (ground mounted)	R3-10 series	2B.48	750 x 1050 (30 x 42)	900 x 1500 (36 x 60)	1200 x 1100 (48 x 84)	—	—
Center Lane HOV 2+ Only (post mounted)	R3-11 series	2B.48	750 x 1050 (30 x 42)	—	1400 x 1100 (54 x 84)	—	—
HOV 2+ Lane Ends (post mounted)	R3-12	2B.48	750 x 1050 (30 x 42)	900 x 1500 (36 x 60)	1200 x 1100 (48 x 84)	—	—
HOV 2+ Lane Ahead (overhead mounted)	R3-13	2B.48	1650 x 900 (66 x 36)	2100 x 1200 (84 x 48)	2550 x 1500 (102 x 60)	—	—
HOV 2+ Only (overhead mounted)	R3-14 series	2B.48	1800 x 1500 (72 x 60)	2400 x 1800 (96 x 72)	2700 x 1100 (108 x 84)	—	—
HOV 2+ Lane Ends (overhead mounted)	R3-15	2B.48	1650 x 900 (66 x 36)	2100 x 1200 (84 x 48)	2550 x 1500 (102 x 60)	—	—

Table 2B-1. Regulatory Sign Sizes (Sheet 2 of 4)

Sign	MUTCD Code	Section	Conventional Roads	Expressways	Freeways	Minimum	Oversized
Bicycle Lane Ahead (symbol)	R3-16	9B.04	600 x 750 (24 x 30)	—	—	—	—
Bicycle Lane Ends (symbol)	R3-16a	9B.04	600 x 750 (24 x 30)	—	—	—	—
Right Lane Bicycle Only (symbol)	R3-17	9B.04	600 x 750 (24 x 30)	—	—	—	—
Bicycle Lane with Vehicle Parking (symbol)	R3-17a	9B.04	600 x 750 (24 x 30)	—	—	—	—
Do Not Pass	R4-1	2B.24	600 x 750 (24 x 30)	900 x 1200 (36 x 48)	1200 x 1500 (48 x 60)	450 x 600 (18 x 24)	—
Pass With Care	R4-2	2B.25	600 x 750 (24 x 30)	900 x 1200 (36 x 48)	1200 x 1500 (48 x 60)	450 x 600 (18 x 24)	—
Slower Traffic Keep Right	R4-3	2B.26	600 x 750 (24 x 30)	900 x 1200 (36 x 48)	1200 x 1500 (48 x 60)	—	—
Trucks Use Right Lane	R4-5	2B.27	600 x 750 (24 x 30)	900 x 1200 (36 x 48)	1200 x 1500 (48 x 60)	—	—
Truck Lane 500 Feet	R4-6	2B.27	600 x 750 (24 x 30)	900 x 1200 (36 x 48)	1200 x 1500 (48 x 60)	—	—
Keep Right	R4-7,7a,7b	2B.28	600 x 750 (24 x 30)	900 x 1200 (36 x 48)	1200 x 1500 (48 x 60)	450 x 600 (18 x 24)	—
Keep Left	R4-8	2B.28	600 x 750 (24 x 30)	900 x 1200 (36 x 48)	1200 x 1500 (48 x 60)	450 x 600 (18 x 24)	—
Do Not Enter	R5-1	2B.29	750 x 750 (30 x 30)	900 x 900 (36 x 36)	1200 x 1200 (48 x 48)	—	—
Wrong Way	R5-1a	2B.30	900 x 600 (36 x 24)	900 x 600 (36 x 24)	1050 x 750 (42 x 30)	—	—
No Trucks	R5-2	2B.31	600 x 600 (24 x 24)	750 x 750 (30 x 30)	900 x 900 (36 x 36)	—	1200 x 1200 (48 x 48)
Motor Vehicle Prohibition	R5-3	2B.31	600 x 600 (24 x 24)	—	—	—	—
Commercial Vehicles Excluded	R5-4	2B.31	600 x 750 (24 x 30)	900 x 1200 (36 x 48)	1200 x 1500 (48 x 60)	—	—
Vehicles with Lugs Prohibited	R5-5	2B.31	600 x 750 (24 x 24)	900 x 1200 (36 x 48)	1200 x 1500 (48 x 60)	—	—
No Bicycles	R5-6	2B.31	600 x 600 (24 x 24)	750 x 750 (30 x 30)	900 x 900 (36 x 36)	—	1200 x 1200 (48 x 48)
Non-Motorized Traffic Prohibited	R5-7	2B.31	750 x 600 (30 x 24)	1050 x 600 (42 x 24)	1200 x 750 (48 x 30)	—	—
Motor Driven Cycles Prohibited	R5-8	2B.31	750 x 600 (30 x 24)	1050 x 600 (42 x 24)	1200 x 750 (48 x 30)	—	—
Pedestrians, Bicycles, Motor Driven Cycles Prohibited	R5-10a	2B.31	750 x 900 (30 x 36)	—	—	—	—
Pedestrians and Bicycles Prohibited	R5-10b	2B.31	750 x 450 (30 x 18)	—	—	—	—
Pedestrians Prohibited	R5-10c	2B.31	600 x 300 (24 x 12)	—	—	—	—
One Way	R6-1	2B.32	900 x 300 (36 x 12)	—	—	—	—
One Way	R6-2	2B.32	450 x 600 (18 x 24)	—	—	—	600 x 750 (24 x 30)
Divided Highway Crossing	R6-3,3a	2B.33	600 x 450 (24 x 18)	—	—	—	—
No Parking	R7-1,2,2a,3,4,5,6,7,8,8a,9,9a,107,108	2B.34	300 x 450 (12 x 18)	—	—	—	—
No Parking (with transit logo)	R7-107a	2B.34	300 x 750 (12 x 30)	—	—	—	—

Table 2B-1. Regulatory Sign Sizes (Sheet 3 of 4)

Sign	MUTCD Code	Section	Conventional Roads	Expressways	Freeways	Minimum	Oversized
No Parking / Restricted Parking (combined sign)	R7-200	2B.34	500 x 450 (20 x 18)	—	—	—	—
Tow Away Zone	R7-201,201a	2B.34	300 x 150 (12 x 6)	—	—	—	—
This Side of Sign	R7-202	2B.34	300 x 165 (12 x 6.5)	—	—	—	—
No Parking on Pavement	R8-1	2B.34	600 x 750 (24 x 30)	900 x 1200 (36 x 48)	1200 x 1500 (48 x 60)	—	—
No Parking Except on Shoulder	R8-2	2B.34	600 x 750 (24 x 30)	900 x 1200 (36 x 48)	1200 x 1500 (48 x 60)	—	—
No Parking	R8-3	2B.34	600 x 750 (24 x 30)	900 x 900 (36 x 36)	1200 x 1200 (48 x 48)	450 x 600 (18 x 24)	—
No Parking (symbol)	R8-3a	2B.34	600 x 600 (24 x 24)	900 x 900 (36 x 36)	1200 x 1200 (48 x 48)	300 x 300 (12 x 12)	—
Emergency Parking Only	R8-4	2B.37	750 x 600 (30 x 24)	750 x 600 (30 x 24)	1200 x 900 (48 x 36)	—	—
No Stopping on Pavement	R8-5	2B.34	600 x 750 (24 x 30)	900 x 1200 (36 x 48)	1200 x 1500 (48 x 60)	—	—
No Stopping Except on Shoulder	R8-6	2B.34	600 x 750 (24 x 30)	900 x 1200 (36 x 48)	1200 x 1500 (48 x 60)	—	—
Emergency Stopping Only	R8-7	2B.37	750 x 600 (24 x 30)	1200 x 900 (48 x 36)	—	—	—
Do Not Stop on Tracks	R8-8	2B.37	750 x 600 (24 x 30)	900 x 1200 (36 x 48)	1200 x 1500 (48 x 60)	—	—
Walk on Left Facing Traffic	R9-1	2B.38	450 x 600 (18 x 24)	—	—	—	—
Cross Only At Crosswalks	R9-2	2B.39	300 x 450 (12 x 18)	—	—	—	—
Pedestrians Prohibited	R9-3	2B.39	300 x 450 (12 x 18)	—	—	—	—
Pedestrian Prohibition (symbol)	R9-3a	2B.39	450 x 450 (18 x 18)	600 x 600 (24 x 24)	750 x 750 (30 x 30)	—	—
Use Crosswalk	R9-3b	2B.39	450 x 300 (18 x 12)	—	—	—	—
No Hitch Hiking	R9-4	2B.38	450 x 600 (18 x 24)	—	—	450 x 450 (18 x 18)	—
Hitch Hiking Prohibition (symbol)	R9-4a	2B.38	450 x 450 (18 x 18)	—	—	—	—
Bicyclists (symbol) Use Ped Signal	R9-5	9B.09	300 x 450 (12 x 18)	—	—	—	—
Bicyclists (symbol) Yield to Peds	R9-6	9B.09	300 x 450 (12 x 18)	—	—	—	—
Keep Left/Right to Pedestrians & Bicyclists (symbols) – Travel-path Restriction	R9-7	9B.10	300 x 450 (12 x 18)	—	—	—	—
Pedestrian Crosswalk	R9-8	6F.12	600 x 300 (24 x 12)	—	—	—	—
Sidewalk Closed	R9-9	6F.13	600 x 300 (24 x 12)	—	—	—	—
Sidewalk Closed, Use Other Side	R9-10	6F.13	600 x 300 (24 x 12)	—	—	—	—
Sidewalk Closed Ahead, Cross Here	R9-11	6F.13	600 x 300 (24 x 12)	—	—	—	—
Pedestrian Traffic Signal Signs	R10-1	2B.40	300 x 450 (12 x 18)	—	—	—	—

Table 2B-1. Regulatory Sign Sizes (Sheet 4 of 4)

Sign	MUTCD Code	Section	Conventional Roads	Expressways	Freeways	Minimum	Oversized
Pedestrian Traffic Signal Signs	R10-2, 2a,3,3a,3b 3c,4,4a,4b	2B.40	225 x 300 (9 x 12)	—	—	—	—
Left on Green Arrow Only	R10-5	2B.40	600 x 750 (24 x 30)	—	—	—	1200 x 1500 (48 x 60)
Stop Here on Red	R10-6,6a	2B.40	600 x 900 (24 x 36)	—	—	600 x 750 (24 x 30)	—
Do Not Block Intersection	10-7	2B.40	600 x 750 (24 x 30)	—	—	—	—
Use Lane With Green Arrow	R10-8	2B.40	600 x 750 (24 x 30)	900 x 1050 (36 x 42)	—	—	1500 x 1800 (60 x 72)
Left (Right) Turn Signal	R10-10	2B.40	600 x 750 (24 x 30)	—	—	—	—
No Turn on Red	R10-11a, 11c,11d	2B.40	600 x 750 (24 x 30)	—	—	—	1200 x 1200 (48 x 48)
No Turn on Red	R10-11b	2B.40	600 x 600 (24 x 24)	—	—	—	750 x 750 (30 x 30)
Left Turn Yield On (symbolic green ball)	R10-12	2B.40	600 x 750 (24 x 30)	—	—	—	—
Emergency Signal	R10-13	2B.40	900 x 600 (36 x 24)	—	—	—	—
Keep Off Median	R11-1	2B.41	600 x 750 (24 x 30)	—	—	—	—
Road Closed	R11-2	2B.42	1200 x 750 (48 x 30)	—	—	—	—
Road Closed - Local Traffic Only	R11-3a,3b,4	2B.42	1500 x 750 (60 x 30)	—	—	—	—
Weight Limit	R12-1,2	2B.43	600 x 750 (24 x 30)	—	—	—	900 x 1200 (36 x 48)
Weight Limit	R12-3	2B.43	600 x 900 (24 x 36)	—	—	—	—
Weight Limit	R12-4	2B.43	750 x 600 (30 x 24)	—	—	—	—
Weight Limit	R12-5	2B.43	600 x 900 (24 x 36)	900 x 1200 (36 x 48)	1200 x 1500 (48 x 60)	—	—
Weigh Station	R13-1	2B.44	1800 x 1200 (72 x 48)	2400 x 1650 (96 x 66)	3000 x 1100 (120 x 84)	—	—
Truck Route	R14-1	2B.45	600 x 450 (24 x 18)	—	—	—	—
Hazardous Cargo	R14-2,3	2B.46	600 x 600 (24 x 24)	750 x 750 (30 x 30)	900 x 900 (36 x 36)	—	1050 x 1050 (42 x 42)
National Network	R14-4,5	2B.47	600 x 600 (24 x 24)	750 x 750 (30 x 30)	900 x 900 (36 x 36)	—	1050 x 1050 (42 x 42)
Seat Belt Symbol	R16-1	2B.51	375 x 500 (15 x 20)	—	—	—	—

- Notes: 1. Larger signs may be used when appropriate
2. Dimensions are shown in millimeters followed by inches in parentheses and are shown as width x height

Guidance:

The Expressway and Freeway sizes should be used for higher-speed applications to provide larger signs for increased visibility and recognition.

Option:

The Minimum size may be used on low-speed roadways where reduced legend size would be adequate for the regulation or where physical conditions preclude the use of the other sizes.

The Oversized size may be used for those special applications that require increased emphasis, improved recognition, or increased legibility.

Section 2B.04 STOP Sign (R1-1)**Standard:**

When a sign is used to indicate that traffic is always required to stop, a STOP (R1-1) sign shall be used.

The STOP sign shall be an octagon with a white legend and border on a red background. Secondary legends shall not be used on STOP sign faces. If appropriate, a supplemental plaque (R1-3 or R1-4) shall be used to display a secondary legend. Such plaques shall have a white legend and border on a red background. If the number of approach legs controlled by STOP signs at an intersection is three or more, the numeral on the supplemental plaque, if used, shall correspond to the actual number of legs controlled by STOP signs.

At intersections where all approaches are controlled by STOP signs (see Section 2B.07), a supplemental plaque (R1-3 or R1-4) shall be mounted below each STOP sign.

Option:

The ALL WAY (R1-4) supplemental plaque may be used instead of the 4-WAY (R1-3) supplemental plaque.

Support:

The design and application of Stop Beacons are described in Section 4K.05.



R1-1



R1-3



R1-4



R1-2

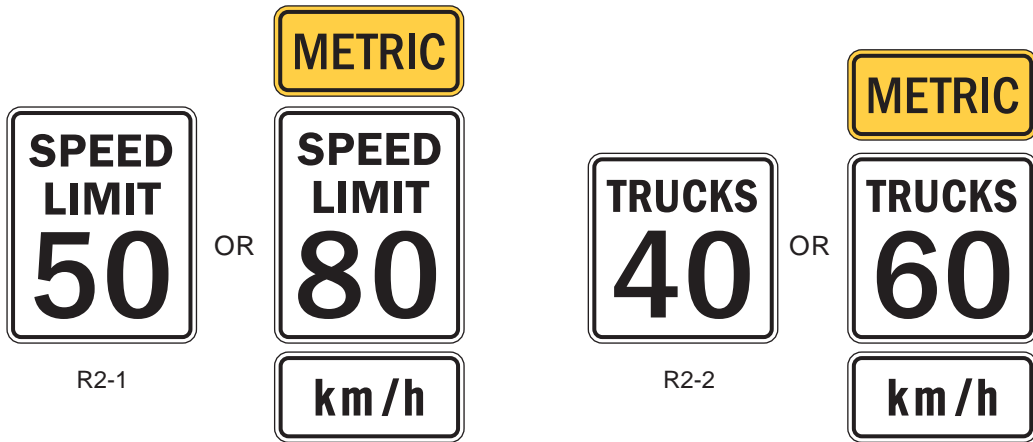

R2-1

R2-2

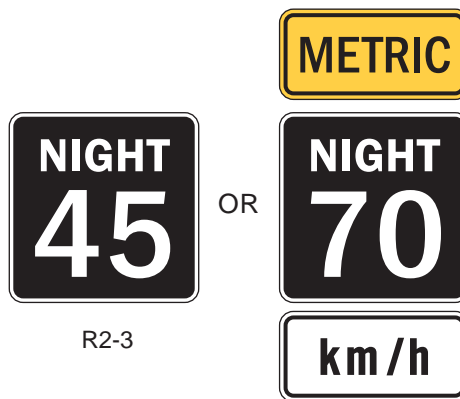

R2-3

Section 2B.05 STOP Sign Applications**Guidance:**

STOP signs should not be used unless engineering judgment indicates that one or more of the following conditions exist:

- A. Intersection of a less important road with a main road where application of the normal right-of-way rule would not be expected to provide reasonably safe operation.
- B. Street entering a through highway or street.
- C. Unsignalized intersection in a signalized area.
- D. High speeds, restricted view, or crash records indicate a need for control by the STOP sign.

Standard:

STOP signs shall not be installed at intersections where traffic control signals are installed and operating because the potential for conflicting commands could create driver confusion.

Portable or part-time STOP signs shall not be used except for emergency and temporary traffic control zone purposes.

Guidance:

STOP signs should not be used for speed control.

STOP signs should be installed in a manner that minimizes the numbers of vehicles having to stop. At intersections where a full stop is not necessary at all times, consideration should be given to using less restrictive measures such as YIELD signs (see Section 2B.08).

Once the decision has been made to install two-way stop control, the decision regarding the appropriate street to stop should be based on engineering judgment. In most cases, the street carrying the lowest volume of traffic should be stopped.

A STOP sign should not be installed on the major street unless justified by a traffic engineering study.

Support:

The following are considerations that might influence the decision regarding the appropriate street upon which to install a STOP sign where two streets with relatively equal volumes and/or characteristics intersect:

- A. Stopping the direction that conflicts the most with established pedestrian crossing activity or school walking routes;
- B. Stopping the direction that has obscured vision, dips, or bumps that already require drivers to use lower operating speeds; and
- C. Stopping the direction that has the longest distance of uninterrupted flow approaching the intersection.
- D. Stopping the direction that has the best sight distance to conflicting traffic.

The use of the STOP sign at highway-railroad grade crossings is described in Section 8B.07.

Section 2B.06 STOP Sign Placement**Standard:**

The STOP sign shall be installed on the right side of the traffic lane to which it applies. When the STOP sign is installed at this required location and the sign visibility is restricted, a Stop Ahead sign (see Section 2C.26) shall be installed in advance of the STOP sign.

The STOP sign shall be located as close as practical to the intersection it regulates, while optimizing its visibility to the road user it is intended to regulate.

STOP signs and YIELD signs shall not be mounted on the same post.

Guidance:

Stop lines, when used to supplement a STOP sign, should be located at the point where the road user should stop (see Section 3B.16).

If only one STOP sign is installed on an approach, the STOP sign should not be placed on the far side of the intersection.

Where two roads intersect at an acute angle, the STOP sign should be positioned at an angle, or shielded, so that the legend is out of view of traffic to which it does not apply.

Where there is a marked crosswalk at the intersection, the STOP sign should be installed in advance of the crosswalk line nearest to the approaching traffic.

Option:

At wide-throat intersections or where two or more approach lanes of traffic exist on the signed approach, observance of the stop control may be improved by the installation of an additional STOP sign on the left side of the road and/or the use of a stop line. At channelized intersections, the additional STOP sign may be effectively placed on a channelizing island.

Support:

Figure 2A-2 shows some typical placements of STOP signs.

Section 2B.07 Multi-Way Stop Applications

Support:

Multi-way stop control can be useful as a safety measure at intersections if certain traffic conditions exist. Safety concerns associated with multi-way stops include pedestrians, bicyclists, and all road users expecting other road users to stop. Multi-way stop control is used where the volume of traffic on the intersecting roads is approximately equal.

The restrictions on the use of STOP signs described in Section 2B.05 also apply to multi-way stop applications.

Guidance:

The decision to install multi-way stop control should be based on an engineering study.

The following criteria should be considered in the engineering study for a multi-way STOP sign installation:

- A. Where traffic control signals are justified, the multi-way stop is an interim measure that can be installed quickly to control traffic while arrangements are being made for the installation of the traffic control signal.
- B. A crash problem, as indicated by five or more reported crashes in a 12-month period that are susceptible to correction by a multi-way stop installation. Such crashes include right- and left-turn collisions as well as right-angle collisions.
- C. Minimum volumes:
 1. The vehicular volume entering the intersection from the major street

approaches (total of both approaches) averages at least 300 vehicles per hour for any 8 hours of an average day, and

2. The combined vehicular, pedestrian, and bicycle volume entering the intersection from the minor street approaches (total of both approaches) averages at least 200 units per hour for the same 8 hours, with an average delay to minor-street vehicular traffic of at least 30 seconds per vehicle during the highest hour, but
 3. If the 85th-percentile approach speed of the major-street traffic exceeds 65 km/h (40 mph), the minimum vehicular volume warrants are 70 percent of the above values.
- D. Where no single criterion is satisfied, but where Criteria B, C.1, and C.2 are all satisfied to 80 percent of the minimum values. Criterion C.3 is excluded from this condition.

Option:

Other criteria that may be considered in an engineering study include:

- A. The need to control left-turn conflicts.
- B. The need to control vehicle/pedestrian conflicts near locations that generate high pedestrian volumes.
- C. Locations where a road user, after stopping, cannot see conflicting traffic and is not able to safely negotiate the intersection unless conflicting cross traffic is also required to stop.
- D. An intersection of two residential neighborhood collector (through) streets of similar design and operating characteristics where multi-way stop control would improve traffic operational characteristics of the intersection.

Section 2B.08 YIELD Sign (R1-2)

Standard:

The YIELD (R1-2) sign shall be a downward-pointing equilateral triangle with a wide red border and the legend YIELD in red on a white background.

Support:

The YIELD sign assigns right-of-way to traffic on certain approaches to an intersection. Vehicles controlled by a YIELD sign need to slow down or stop when necessary to avoid interfering with conflicting traffic.

Section 2B.09 YIELD Sign Applications

Option:

YIELD signs may be installed:

- A. When the ability to see all potentially conflicting traffic is sufficient to allow a road user traveling at the posted speed, the 85th-percentile speed, or the statutory speed to pass through the intersection or to stop in a safe manner.
- B. If controlling a merge-type movement on the entering roadway where acceleration geometry and/or sight distance is not adequate for merging traffic operation.
- C. At the second crossroad of a divided highway, where the median width is 9 m (30 ft) or greater. A STOP sign may be installed at the entrance to the first roadway of a divided highway and a YIELD sign may be installed at the entrance to the second roadway.
- D. At an intersection where a special problem exists and where engineering judgment indicates the problem to be susceptible to correction by the use of the YIELD sign.

Section 2B.10 YIELD Sign Placement

Standard:

The YIELD sign shall be installed on the right side of the traffic lane to which it applies. When the YIELD sign is installed at this required location and the sign visibility is restricted, a Yield Ahead sign (see Section 2C.26) shall be installed in advance of the YIELD sign.

The YIELD sign shall be located as close as practical to the intersection it regulates, while optimizing its visibility to the road user it is intended to regulate.

YIELD signs and STOP signs shall not be mounted on the same post.

Guidance:

YIELD lines, when used to supplement a YIELD sign, should be located at a point where the road user should yield (see Section 3B.16).

Where two roads intersect at an acute angle, the YIELD sign should be positioned at an angle, or shielded, so that the legend is out of view of traffic to which it does not apply.

Where there is a marked crosswalk at the intersection, the YIELD sign should be installed in advance of the crosswalk line nearest to the approaching traffic.

Section 2B.11 Speed Limit Sign (R2-1)**Standard:**

After an engineering study has been made in accordance with established traffic engineering practices, the Speed Limit (R2-1) sign shall display the limit established by law, ordinance, regulation, or as adopted by the authorized agency. The speed limits shown shall be in multiples of 10 km/h (5 mph).

If a metric speed limit is displayed, the METRIC supplemental plaque shall be placed above the sign and the km/h supplemental plaque shall be placed below.

Support:

The METRIC supplemental plaque, which has a yellow background with a black legend and border, indicates to road users that the metric system is being used.

Guidance:

No more than three speed limits should be displayed on any one Speed Limit sign or assembly.

When a speed limit is to be posted, it should be the 85th-percentile speed of free-flowing traffic, rounded up to the nearest 10 km/h (5 mph) increment.

Option:

Other factors that may be considered when establishing speed limits are the following:

- A. Road characteristics, shoulder condition, grade, alignment, and sight distance.
- B. The pace speed.
- C. Roadside development and environment.
- D. Parking practices and pedestrian activity.
- E. Reported crash experience for at least a 12-month period.

Two types of Speed Limit signs may be used: one to designate passenger car speeds, including any nighttime information or minimum speed limit that might apply; and the other to show any special speed limits for trucks and other vehicles.

A changeable message sign that changes for traffic and ambient conditions may be installed provided that the appropriate speed limit is shown at the proper times.

Support:

Advisory Speed signs are discussed in Sections 2C.33 and 2C.42 and Temporary Traffic Control Zone Speed signs are discussed in Part 6.

Section 2B.12 Truck Speed Limit Sign (R2-2)

Standard:

Where a special speed limit applies to trucks or other vehicles, the legend TRUCKS XX or such similar legend shall be shown on the same panel as the Speed Limit sign or on a separate sign (R2-2) below the standard legend.

Section 2B.13 Night Speed Limit Sign (R2-3)

Standard:

Where different speed limits are prescribed for day and night, both limits shall be posted.

Guidance:

A Night Speed Limit (R2-3) sign should be reversed using a white retroreflectorized border and legend on a black background.

Option:

Posting day and night speed limits may be done in any of the following ways:

- A. A Night Speed Limit sign may be combined with or installed below the standard Speed Limit (R2-1) sign.
- B. A changeable message sign may be used for day/night speed limits provided that the appropriate speed limit is shown at the proper times.

Section 2B.14 Minimum Speed Limit Sign (R2-4)

Standard:

A Minimum Speed Limit (R2-4) sign shall be displayed only in combination with a Speed Limit sign.

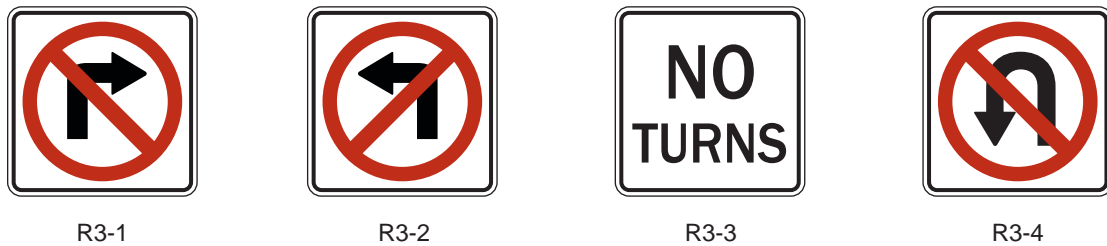
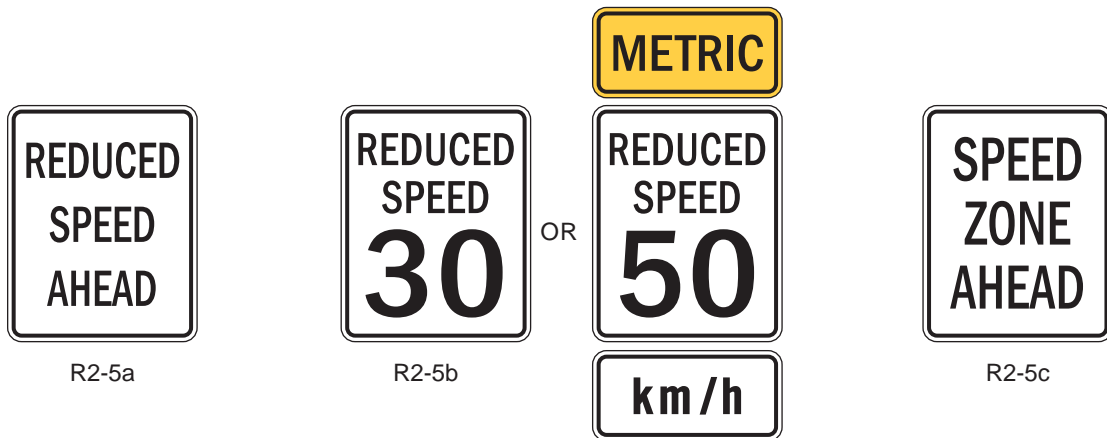
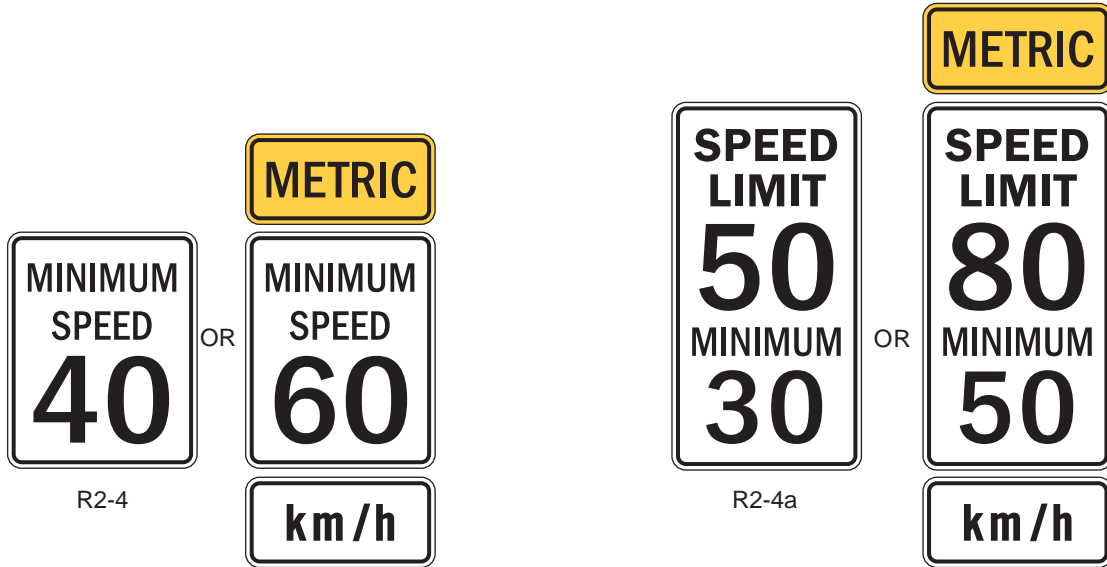

Option:

Where engineering judgment determines that slow speeds on a highway might impede the normal and reasonable movement of traffic, the Minimum Speed Limit sign may be installed below a Speed Limit (R2-1) sign to indicate the minimum legal speed. If desired, these two signs may be combined on the R2-4a sign.

Section 2B.15 Location of Speed Limit Signs

Standard:

Speed Limit (R2-1) signs, indicating speed limits for which posting is required by law, shall be located at the points of change from one speed limit to another.

At the end of the section to which a speed limit applies, a Speed Limit sign showing the next speed limit shall be installed. Additional Speed Limit signs shall be installed beyond major intersections and at other locations where it is necessary to remind road users of the speed limit that is applicable.

Speed Limit signs indicating the statutory speed limits shall be installed at entrances to the State and at jurisdictional boundaries of metropolitan areas.

Section 2B.16 Reduced Speed Ahead Signs (R2-5 Series)

Guidance:

The Reduced Speed Ahead (R2-5 series) signs should be used to inform road users of a reduced speed zone when engineering judgment indicates the need for advance notice to comply with the speed limit posted ahead.

Guidance:

This sign should not be used in urban areas where speeds are relatively low.

Standard:

The Reduced Speed Ahead (R2-5 series) signs shall be followed by a Speed Limit (R2-1) sign installed at the beginning of the zone where the speed limit applies.

Option:

The following methods may be used to provide road users with advance notice of a change in the speed limit:

- A. Any of the R2-5 series of signs may be displayed.
- B. An assembly consisting of the Speed Limit (R2-1) sign with a supplemental legend plaque BEGIN mounted above the R2-1 sign and a supplemental distance plaque, such as 1/6 km or 1/4 mi, mounted below the R2-1 sign may be displayed.

Guidance:

When used with Speed Limit assemblies, the supplemental plaques should have a white background with a black legend and border, except for the METRIC plaque (see Section 2B.11).

Section 2B.17 Turn Prohibition Signs (R3-1 through R3-4)

Standard:

Except as noted in the Option, where turns are prohibited, Turn Prohibition signs shall be installed.

Guidance:

Turn Prohibition signs should be placed where they will be most easily seen by road users who might be intending to turn.

If No Right Turn (R3-1) signs are used, at least one should be placed either over the roadway or at a right corner of the intersection.

If No Left Turn (R3-2) signs are used, at least one should be placed either over the roadway, at a left corner of the intersection, on a median, or in conjunction with the STOP sign or YIELD sign located on the near right corner.

Except as noted in the Option, if NO TURNS (R3-3) signs are used, two signs should be used, one at a location specified for a No Right Turn sign and one at a location specified for a No Left Turn sign.

If No U-Turn (R3-4) signs are used, at least one should be used at a location specified for No Left Turn signs.

Option:

If signals are present:

- A. The No Right Turn sign may be installed adjacent to a signal face viewed by road users in the right lane.

- B. The No Left Turn (or No U-Turn) sign may be installed adjacent to a signal face viewed by road users in the left lane.
- C. A NO TURNS sign may be placed adjacent to a signal face viewed by all road users on that approach, or two signs may be used.

If signals are present, an additional Turn Prohibition sign may be post mounted to supplement the sign mounted overhead.

Where ONE WAY signs are used, Turn Prohibition signs may be omitted (see Section 2B.32).

When the movement restriction applies during certain time periods only, the following Turn Prohibition signing alternatives may be used and are listed in order of preference:

- A. Changeable message signs, especially at signalized intersections.
- B. Permanently mounted signs incorporating a supplementary legend showing the hours and days during which the prohibition is applicable.
- C. Portable signs, installed by proper authority, located off the roadway at each corner of the intersection. The portable signs are only to be used during the time that the turn prohibition is applicable.

Turn Prohibition signs may be omitted at a ramp entrance to an expressway or a channelized intersection where the design is such as to indicate clearly the one-way traffic movement on the ramp or turning lane.

Section 2B.18 Intersection Lane Control Signs (R3-5 through R3-8)

Standard:

Intersection Lane Control signs, if used, shall require road users in certain lanes to turn, shall permit turns from a lane where such turns would otherwise not be permitted, shall require a road user to stay in the same lane and proceed straight through an intersection, or shall indicate permitted movements from a lane.

Intersection Lane Control signs shall have three applications:

- A. Mandatory Movement Lane Control (R3-5, R3-5a, and R3-7) signs**
- B. Optional Movement Lane Control (R3-6) sign**
- C. Advance Intersection Lane Control (R3-8 series) signs**



R3-5



R3-5a

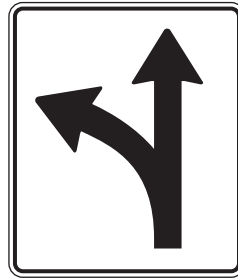

R3-6



R3-7



R3-5b
Supplemental Plaque



*R3-5c
Supplemental Plaque



R3-5d
Supplemental Plaque

* - The diamond symbol may be used instead of the word message "HOV."
The minimum vehicle occupancy level may vary, such as 2+, 3+, 4+.
The words "LANE" or "ONLY" may be used with this sign when appropriate.



R3-8

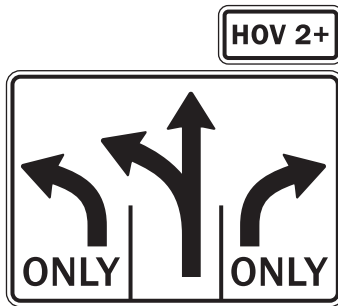

R3-8a

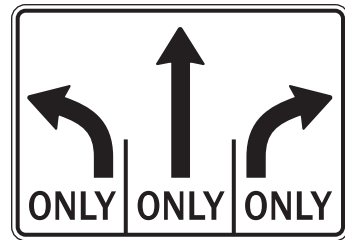

R3-8b

Guidance:

When used, Intersection Lane Control signs should be mounted overhead, and each sign should be placed over a projection of the lane to which it applies.

Standard:

Use of an overhead sign for one approach lane shall not require installation of overhead signs for the other lanes of that approach.

Option:

Where the number of through lanes on an approach is two or less, the Intersection Lane Control signs (R3-5, R3-6, or R3-8) may be overhead or ground mounted.

Intersection Lane Control signs may be omitted where:

- A. Turning bays have been provided by physical construction or pavement markings, and
- B. Only the road users using such turning bays are permitted to make a similar turn.

Section 2B.19 Mandatory Movement Lane Control Signs (R3-5, R3-5a, and R3-7)**Standard:**

If used, Mandatory Movement Lane Control signs (R3-5, R3-5a, and R3-7) shall indicate only those vehicle movements that are required from each lane and shall be located where the regulation applies. When the mandatory movement applies to lanes exclusively designated for HOV traffic, the R3-5c supplemental plaque shall be used. When the mandatory movement applies to lanes that are not HOV facilities, but are lanes exclusively designated for buses and/or taxis, the word message R3-5d supplemental plaque BUS (and/or TAXI) LANE shall be used. The R3-7 word message sign shall be for ground mounting only.

If the R3-5 sign is ground mounted on a multi-lane approach, a supplemental plaque, such as LEFT LANE (R3-5b), HOV 2+ (R3-5c), TAXI LANE (R3-5d), CENTER LANE, RIGHT LANE, or LEFT 2 LANES, indicating the lane with the appropriate movement shall be added below.

The Mandatory Movement Lane Control (R3-7) sign shall include the legend RIGHT (LEFT) LANE MUST TURN RIGHT (LEFT). The Mandatory Movement Lane Control symbol signs (R3-5 and R3-5a) shall include the legend ONLY.

Guidance:

If used, Mandatory Movement Lane Control signs should be accompanied by lane control pavement markings, especially where traffic volumes are high, where there is a high percentage of commercial vehicles, or where other distractions exist.

Option:

The Straight Through Only (R3-5a) sign may be used to require a road user in a particular lane to proceed straight through an intersection.

When the Mandatory Movement Lane Control sign for a left-turn lane is installed back-to-back with a Keep Right (R4-7) sign, the dimensions of the Mandatory Movement Lane Control (R3-5) sign may be the same as the Keep Right sign.

Except for the R3-7 sign, Mandatory Movement Lane Control signs may be overhead or ground mounted.

The diamond symbol may be used instead of the word message HOV on the R3-5c supplemental plaque.

Section 2B.20 Optional Movement Lane Control Sign (R3-6)**Standard:**

If used, the Optional Movement Lane Control (R3-6) sign shall be used for two or more movements from a specific lane or to emphasize permitted movements. If used, the Optional Movement Lane Control sign shall be located at the intersection.

If used, the Optional Movement Lane Control sign shall indicate all permissible movements from specific lanes.

Optional Movement Lane Control signs shall be used for two or more movements from a specific lane where a movement, not normally allowed, is permitted.

The Optional Movement Lane Control sign shall not be used alone to effect a turn prohibition.

Option:

The word message OK may be used within the border in combination with the arrow symbols of the R3-6 sign.

Section 2B.21 Advance Intersection Lane Control Signs (R3-8 Series)**Option:**

Advance Intersection Lane Control (R3-8, R3-8a, and R3-8b) signs may be used to indicate the configuration of all lanes ahead.

The word messages ONLY, OK, THRU, ALL, or HOV 2+ may be used within the border in combination with the arrow symbols of the R3-8 sign series. The HOV 2+ (R3-5c) supplemental plaque may be installed at the top outside border of the R3-8 sign over the applicable lane. The diamond symbol may be used instead of the word message HOV. The minimum allowable vehicle occupancy requirement may vary based on the level established for a particular facility.

Guidance:

If used, an Advance Intersection Lane Control sign should be placed at an adequate distance in advance of the intersection so that road users can select the appropriate lane. If used, the Advance Intersection Lane Control sign should be installed either in advance of the tapers or at the beginning of the turn lane.

Section 2B.22 Two-Way Left Turn Only Signs (R3-9a, R3-9b)**Guidance:**

Two-Way Left Turn Only (R3-9a or R3-9b) signs should be used in conjunction with the required pavement markings where a non-reversible lane is reserved for the exclusive use of left-turning vehicles in either direction and is not used for passing, overtaking, or through travel.

Option:

The ground-mounted R3-9b sign may be used as an alternate to or a supplement to the overhead-mounted R3-9a sign. The legend BEGIN or END may be used within the border of the main sign itself, or on a plaque mounted immediately above it.

Support:

Signing is especially helpful to drivers in areas where the two-way left turn only maneuver is new, in areas subject to environmental conditions that frequently obscure the pavement markings, and on peripheral streets with two-way left turn only lanes leading to an extensive system of routes with two-way left turn only lanes.



R3-9a



R3-9b



R3-9c

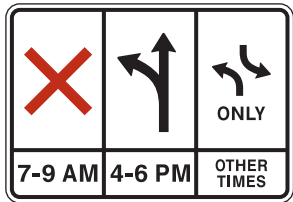

R3-9d

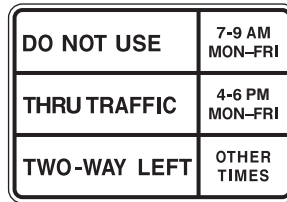

R3-9e



R3-9f

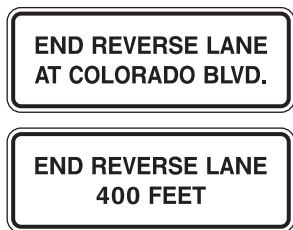

R3-9g

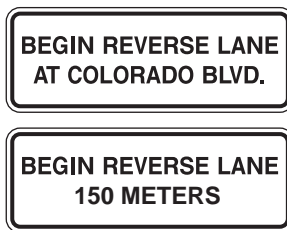

R3-9h



R3-9i

Section 2B.23 Reversible Lane Control Signs (R3-9c through R3-9i)**Option:**

A reversible lane may be used for through traffic (with left turns either permitted or prohibited) in alternating directions during different periods of the day, and the lane may be used for exclusive left turns in one or both directions during other periods of the day as well. Reversible Lane Control (R3-9c through R3-9i) signs may either be static type or changeable message type. These signs may be either ground or overhead mounted.

Standard:

Ground-mounted Reversible Lane Control signs shall be used only as a supplement to overhead signs or signals. Ground-mounted signs shall be identical in design to the overhead signs and an additional legend such as CENTER LANE shall be added to the sign (R3-9f) to indicate which lane is controlled. For both word messages and symbols, this legend shall be at the top of the sign.

Where it is determined by an engineering study that lane-use control signals or barriers are not necessary, the lane shall be controlled by overhead Reversible Lane Control signs (see Figure 2B-1).

Option:

Reversing traffic flow may be controlled with pavement markings and Reversible Lane Control signs (without the use of lane control signals), when all of the following conditions are met:

- A. Only one lane is being reversed.
- B. An engineering study indicates that sign operation alone would result in a level of safety and efficiency that is acceptable.
- C. There are no unusual or complex operations in the reversible lane pattern.

Standard:

Reversible Lane Control signs shall contain the legend or symbols designating the allowable uses of the lane and the time periods such uses are allowed. Where symbols and legend are used, their meanings shall be as shown in Table 2B-2.

Reversible Lane Control signs shall consist of a white background with a black legend and border, except for the R3-9c and R3-9d signs where the color red is used.

Symbol signs, such as the R3-9c or R3-9d signs, shall consist of the appropriate symbol in the upper portion of the sign with the appropriate times of the day and

Figure 2B-1. Location of Reversible Two-Way Left-Turn Signs

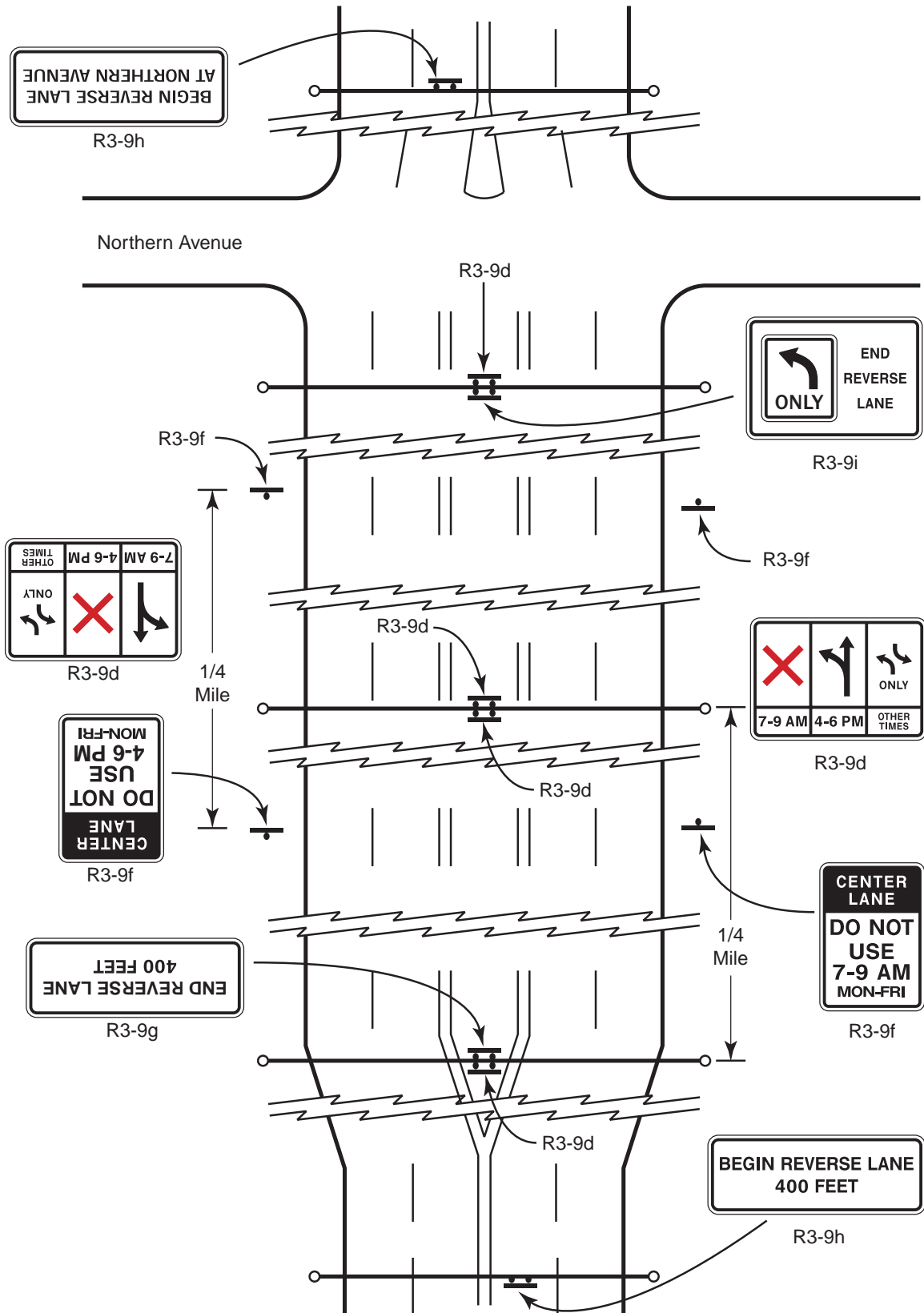

Table 2B-2. Meanings of Symbols and Legends on Reversible Lane Control Signs

Symbol / Word Message	Meaning
Red X on white background or symbolic DO NOT ENTER sign.	Lane Closed
Upward pointing black arrow on white background. If left turns are permitted, the arrow shall be modified to show left / through arrow.	Lane open for thru travel and any turns not otherwise prohibited.
Black two-way left turn arrows on white background and legend ONLY.	Lane may be used only for left turns in either direction (i.e. as a two-way left turn lane).
Black single left turn arrow on white background and legend ONLY.	Lane may be used only for left turns in one direction (without opposing left turns in the same lane).

days of the week below it. Where word message signs, such as R3-9e, are used, the times of the day and the days of the week, when appropriate, shall be on the right portion of the sign and the appropriate legend to the left. All times of the day and days of the week shall be accounted for on the sign to eliminate confusion to the road user.

In situations where more than one message is conveyed to the road user, such as on the R3-9d or R3-9e signs, the sign legend shall be arranged as follows:

- A. The prohibition or restriction message is the primary legend and shall be on the top for word message signs and to the far left for symbol signs;
- B. The permissive use message shall be shown as the second legend; and
- C. The OTHER TIMES message shall be shown at the bottom for word message signs and to the far right for symbol signs.

Option:

The symbol signs may also include a downward pointing arrow with the legend THIS LANE. The term OTHER TIMES may be used for either the symbol or word message sign.

Standard:

A Reversible Lane Control sign shall be mounted over the center of the lane that is being reversed, and shall be perpendicular to the roadway alignment.

If the vertical or horizontal alignment is curved to the degree that a driver would be unable to see at least one sign, and preferably two signs, then additional overhead signs shall be installed. The placement of the signs shall be such that the driver will have a definite indication of the lanes specifically reserved for use at any given time. Special consideration shall be given to major generators introducing traffic between the normal sign placement.

Transitions at the entry to and exit from section of roadway with reversible lanes shall be carefully reviewed, and advance signs shall be installed to notify or warn drivers of the boundaries of the reversible lane controls. The R3-9g or R3-9h signs shall be used for this purpose.

Option:

More than one sign may be used at the termination of the reversible lane to emphasize the importance of the message (R3-9i).

Standard:

Flashing beacons, if used to accentuate the overhead Reversible Lane Control signs, shall comply with the applicable requirements for flashing beacons in Chapter 4K.

When used in conjunction with Reversible Lane Control signs, the Turn Prohibition signs (R3-1 to R3-4) shall be mounted overhead and separate from the Reversible Lane Control signs. The Turn Prohibition signs shall be designed and installed in accordance with Section 2B.17.

Guidance:

For additional emphasis, a supplemental plaque stating the distance of the prohibition, such as NEXT 1.6 KM (NEXT 1 MILE), should be added to the Turn Prohibition signs that are used in conjunction with Reversible Lane Control signs.

If used, overhead signs should be located at intervals not greater than 0.4 km (0.25 mi). The bottom of the overhead Reversible Lane Control signs should not be more than 5.8 m (19 ft) above the pavement grade.

Where more than one sign is used at the termination of a reversible lane, they should be at least 75 m (250 ft) apart. Longer distances between signs are appropriate for streets with speeds over 60 km/h (35 mph), but the separation should not exceed 300 m (1,000 ft).

Left-turning vehicles have a significant impact on the safety and efficiency of a reversible lane operation. If an exclusive left-turn lane or two-way left-turn lane cannot

be incorporated into the lane-use pattern for a particular peak or off-peak period, consideration should be given to prohibiting left turns and U-turns during that time period.

Section 2B.24 DO NOT PASS Sign (R4-1)

Option:

The DO NOT PASS (R4-1) sign may be used in addition to pavement markings (see Section 3B.02) to emphasize the restriction on passing. The DO NOT PASS sign may be used at the beginning of, and at intervals within, a zone through which sight distance is restricted or where other conditions make overtaking and passing inappropriate.

If signing is needed on the left side of the roadway for additional emphasis, NO PASSING ZONE (W14-3) signs may be used (see Section 2C.32).

Support:

Standards for determining the location and extent of no-passing zone pavement markings are set forth in Section 3B.02.

Section 2B.25 PASS WITH CARE Sign (R4-2)

Guidance:

The PASS WITH CARE (R4-2) sign should be installed at the end of a no-passing zone if a DO NOT PASS sign has been installed at the beginning of the zone.

Section 2B.26 SLOWER TRAFFIC KEEP RIGHT Sign (R4-3)

Option:

The SLOWER TRAFFIC KEEP RIGHT (R4-3) sign may be used on multi-lane roadways to reduce unnecessary lane changing.

Guidance:

If used, the SLOWER TRAFFIC KEEP RIGHT (R4-3) sign should be installed just beyond the beginning of a multi-lane pavement, and at selected locations where there is a tendency on the part of some road users to drive in the left lane (or lanes) below the normal speed of traffic. This sign should not be used on the approach to an interchange or through an interchange area.



R4-1



R4-2



R4-3



R4-5



R4-6

OR

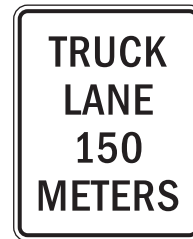

R4-7



R4-7a



R4-7b

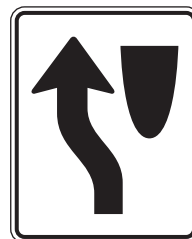

R4-8

Section 2B.27 Slow Moving Traffic Lane Signs (R4-5, R4-6)

Support:

The Slow Moving Traffic Lane signs are used to direct vehicles into an extra lane that has been provided for slow-moving vehicles.

If an extra lane has been provided for slow-moving traffic, a SLOWER TRAFFIC KEEP RIGHT (R4-3) sign, TRUCKS USE RIGHT LANE (R4-5) sign, or other appropriate sign should be installed at the beginning of the lane. A TRUCK LANE (R4-6) sign, with the appropriate distance shown, should be installed in advance of the lane.

Option:

The SLOWER TRAFFIC KEEP RIGHT sign may be used as a supplement or as an alternative to the TRUCKS USE RIGHT LANE (R4-5). Both signs may be used on multi-lane roadways to improve capacity and reduce lane changing.

Guidance:

If an extra lane has been provided for slow-moving traffic, a Lane Ends sign (see Section 2C.30) should be installed in advance of the point where the extra lane ends. Appropriate pavement markings should be installed at both the beginning and the end of the extra lane (see Section 3B.09 and Figure 3B-12).

Section 2B.28 Keep Right and Keep Left Signs (R4-7, R4-8)

Option:

The Keep Right (R4-7) sign may be used at locations where it is necessary for traffic to pass only to the right of a roadway feature or obstruction.

Guidance:

If used, the Keep Right sign should be installed as close as practical to approach ends of raised medians, parkways, islands, underpass piers, and at other locations where it is not readily apparent that traffic is required to keep to the right. The sign should be mounted on the face of or just in front of a pier or other obstruction separating opposite directions of traffic in the center of the highway.

Option:

The Keep Right sign may be omitted at intermediate ends of divisional islands and medians.

The word message KEEP RIGHT (LEFT) with an arrow (R4-7a or R4-7b) may be used instead of the R4-7 symbol sign.

Where appropriate, a Keep Left (R4-8) symbol sign may be used.

Where the obstruction obscures the Keep Right sign, the minimum placement height may be increased for better sign visibility.

Section 2B.29 DO NOT ENTER Sign (R5-1)

Standard:

The DO NOT ENTER (R5-1) sign shall be used where traffic is prohibited from entering a restricted roadway.

Guidance:

The DO NOT ENTER sign, if used, should be placed at the point where a road user could wrongly enter a one-way roadway or ramp. The sign should be mounted on the right side of the roadway, facing traffic that might enter the roadway or ramp in the wrong direction.

If the DO NOT ENTER sign would be visible to traffic to which it does not apply, the sign should be turned away from, or shielded from, the view of that traffic.

Option:

The DO NOT ENTER sign may be installed where it is necessary to emphasize the one-way traffic movement on a ramp or turning lane.

A second DO NOT ENTER sign on the left side of the roadway may be used, particularly where traffic approaches from an intersecting roadway (see Figures 2A-3 and 2B-2).

Section 2B.30 WRONG WAY Sign (R5-1a)

Option:

The WRONG WAY (R5-1a) sign may be used as a supplement to the DO NOT ENTER sign where an exit ramp intersects a crossroad or a crossroad intersects a one-way roadway in a manner that does not physically discourage or prevent wrong-way entry (see Figures 2A-3 and 2B-2).

Guidance:

If used, the WRONG WAY sign should be placed at a location along the exit ramp or the one-way roadway farther from the crossroad than the DO NOT ENTER sign (see Section 2E.50).



R5-1



R5-1a



R5-2



R5-3



R5-4



R5-5



R5-6



R5-7

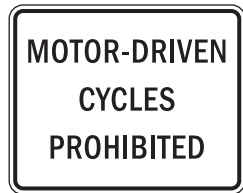

R5-8

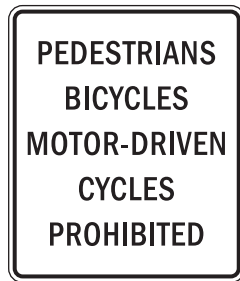

R5-10a



R5-10b



R5-10c

Figure 2B-2. Typical Wrong-Way Signing for Divided Highways

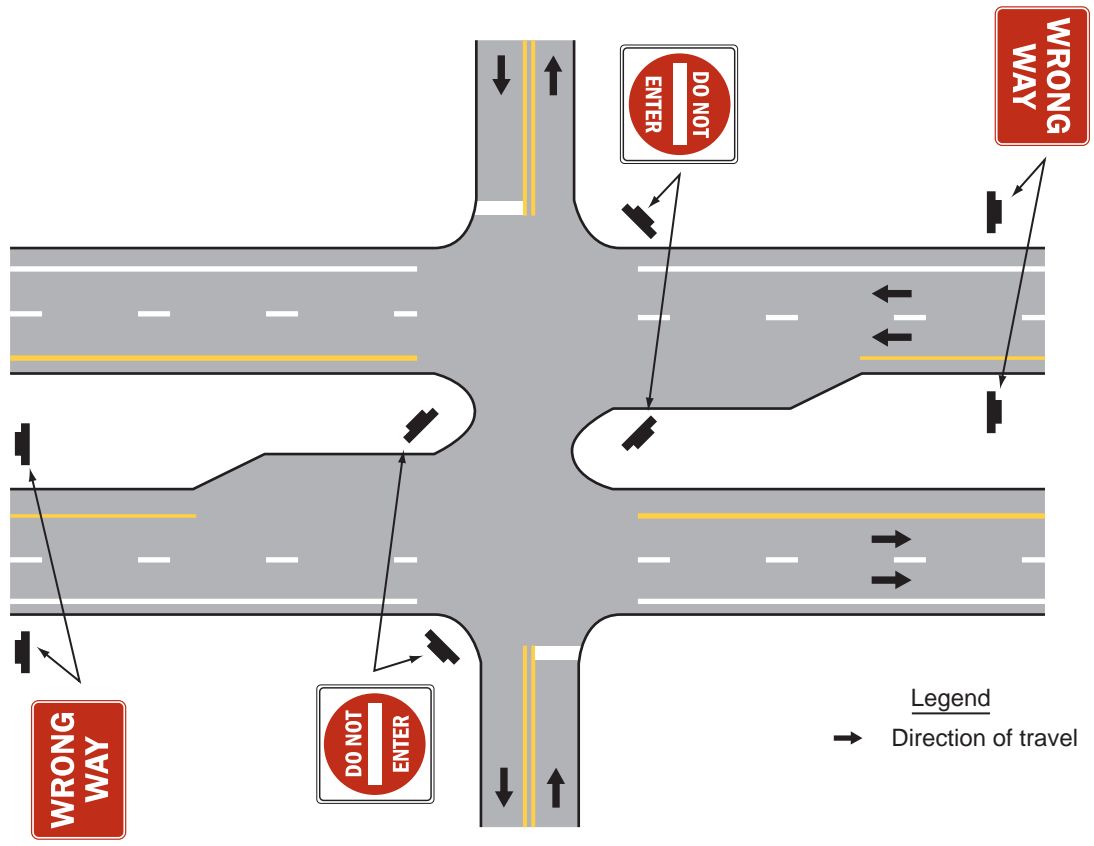

Section 2B.31 Selective Exclusion Signs**Support:**

Selective Exclusion signs give notice to road users that State or local statutes or ordinances exclude designated types of traffic from using particular roadways or facilities.

Standard:

If used, Selective Exclusion signs shall clearly indicate the type of traffic that is excluded.

Support:

Typical exclusion messages include:

No Trucks (R5-2),
NO MOTOR VEHICLES (R5-3),
COMMERCIAL VEHICLES EXCLUDED (R5-4),
TRUCKS (VEHICLES) WITH LUGS PROHIBITED (R5-5),
No Bicycles (R5-6),
NON-MOTORIZED TRAFFIC PROHIBITED (R5-7),
MOTOR-DRIVEN CYCLES PROHIBITED (R5-8), and
Hazardous Cargo Prohibited (R14-3).

Option:

Appropriate combinations or groupings of these legends into a single sign, such as PEDESTRIANS BICYCLES MOTOR-DRIVEN CYCLES PROHIBITED (R5-10a), or PEDESTRIANS AND BICYCLES PROHIBITED (R5-10b) may be used.

Guidance:

If an exclusion is governed by vehicle weight, a Weight Limit sign (see Section 2B.43) should be used instead of a Selective Exclusion sign.

The Selective Exclusion sign should be placed on the right side of the roadway at an appropriate distance from the intersection so as to be clearly visible to all road users turning into the roadway that has the exclusion. The PEDESTRIANS PROHIBITED (R5-10c or R9-3a) sign should be installed so as to be clearly visible to pedestrians at a location where an alternative route is available.

Option:

The word message NO TRUCKS may be used as an alternate to the No Trucks (R5-2) symbol sign.

The PEDESTRIAN PROHIBITED (R5-10c or R9-3a) sign may also be used at underpasses or elsewhere where pedestrian facilities are not provided.

Section 2B.32 ONE WAY Signs (R6-1, R6-2)

Standard:

Except as noted in the Option, the ONE WAY (R6-1 or R6-2) sign shall be used to indicate streets or roadways upon which vehicular traffic is allowed to travel in one direction only.

ONE WAY signs shall be placed parallel to the one-way street at all alleys and roadways that intersect one-way roadways.

Guidance:

Where divided highways are separated by median widths of 9 m (30 ft) or more, ONE WAY signs (see Section 2B.32) should be placed and visible to each crossroad approach on the near right and far left corners of each intersection with the directional roadways as shown in Figures 2A-4 and 2A-5.

Option:

ONE WAY signs may be omitted on the one-way roadways of divided highways, where the design of interchanges indicates the direction of traffic on the separate roadways.

ONE WAY signs may be omitted at intersections with divided highways that have median widths of less than 9 m (30 ft).

Support:

Figures 2A-3, 2A-4, 2A-5, and 2A-6 show examples of the application of ONE WAY signs.

Standard:

At unsignalized intersections, ONE WAY signs shall be placed on the near right and the far left corners of the intersection facing traffic entering or crossing the one-way street.

At signalized intersections, ONE WAY signs shall be placed either near the appropriate signal faces, on the poles holding the traffic signals, on the mast arm or span wire holding the signals, or at the locations specified for unsignalized intersections.



R6-1



R6-2



R6-3



R6-3a

Section 2B.33 Divided Highway Crossing Signs (R6-3, R6-3a)

Option:

The Divided Highway Crossing (R6-3 or R6-3a) sign may be used to advise road users that they are approaching an intersection with a divided highway.

Standard:

When the Divided Highway Crossing sign is used at a four-legged intersection, the R6-3 sign shall be used. When used at a T-intersection, the R6-3a sign shall be used.

Option:

The Divided Highway Crossing sign may be located on the near right corner of the intersection and may be mounted beneath a STOP or YIELD sign or on a separate support.

Section 2B.34 Parking, Standing, and Stopping Signs (R7 and R8 Series)

Support:

Signs governing the parking, stopping, and standing of vehicles cover a wide variety of regulations and only general guidance can be provided here. Typical examples of parking, stopping, and standing signs are as follows:

NO PARKING ANY TIME (R7-1),
 NO PARKING 8:30 AM to 5:30 PM (R7-2),
 NO PARKING EXCEPT SUNDAYS AND HOLIDAYS (R7-3),
 NO STANDING ANY TIME (R7-4),
 ONE HOUR PARKING 9 AM-7 PM (R7-5),
 NO PARKING LOADING ZONE (R7-6),
 NO PARKING BUS STOP (R7-7, R7-107, R7-107a),
 RESERVED PARKING for persons with disabilities (R7-8),
 NO PARKING ON PAVEMENT (R8-1),
 NO PARKING EXCEPT ON SHOULDER (R8-2),
 NO PARKING (R8-3),
 NO PARKING (R8-3a), and
 NO STOPPING ON PAVEMENT (R8-5).

Section 2B.35 Design of Parking, Standing, and Stopping Signs

Support:

Discussions of parking signs and parking regulations in this Section apply not only to parking, but also to standing and stopping.

Standard:

The legend on parking signs shall state applicable regulations. Parking signs shall conform to the standards of shape, color, and location.

Where parking is prohibited at all times or at specific times, the basic design for parking signs shall have a red legend and border on a white background (Parking Prohibition signs). Where only limited-time parking or parking in a particular manner are permitted, the signs shall have a green legend and border on a white background (Permissive Parking signs).

Guidance:

Parking signs should display the following information from top to bottom of the sign, in the order listed:



R7-1



R7-2



R7-2a



R7-3



R7-4



R7-5



R7-6



R7-7



R7-8



R7-107



R7-107a



R7-108



R7-201



R7-201a



R8-1



R8-2



R8-3



R8-3a



R8-4



R8-5



R8-6



R8-7



R8-3c
Supplemental Plaque



R8-3d
Supplemental Plaque

- A. The restriction or prohibition.
- B. The times of the day that it is applicable, if not at all hours.
- C. The days of the week that it is applicable, if not every day.

If the parking restriction applies to a limited area or zone, the limits of the restriction should be shown by arrows or supplemental plaques.

If arrows are used and if the sign is at the end of a parking zone, there should be a single-headed arrow pointing in the direction that the regulation is in effect. If the sign is at an intermediate point in a zone, there should be a double-headed arrow pointing both ways.

When a single sign is used at the transition point between two parking zones, it should display a right and left arrow pointing in the direction that the respective restrictions apply.

Option:

To minimize the number of parking signs, blanket regulations that apply to a given district may, if legal, be posted at district boundary lines.

As an alternate to the use of arrows to show designated restriction zones, word messages such as BEGIN, END, HERE TO CORNER, HERE TO ALLEY, THIS SIDE OF SIGN, or BETWEEN SIGNS may be used.

Where parking is prohibited during certain hours and time-limited parking or parking in a particular manner is permitted during certain other time periods, the red Parking Prohibition and green Permissive Parking signs may be designed as follows:

- A. Two 300 x 450 mm (12 x 18 in) parking signs may be used with the red Parking Prohibition sign installed above or to the left of the green Permissive Parking sign; or
- B. The red Parking Prohibition sign and the green Permissive Parking sign may be combined on a single 600 x 450 mm (24 x 18 in) sign, or on a single 300 x 900 mm (12 x 36 in) sign.

At the transition point between two parking zones, a single sign or two signs mounted side by side may be used.

The words NO PARKING may be used as an alternative to the No Parking symbol. The supplemental educational plaque, NO PARKING, with a red legend and border on a white background, may be used above signs incorporating the No Parking symbol.

Alternate designs for the R7-107 sign may be developed such as the R7-107a sign. Alternate designs may include, on a single panel, a transit logo, an approved bus symbol, a parking

prohibition, the words BUS STOP, and an arrow. The preferred bus symbol color is black, but other dark colors may be used. Additionally, the transit logo may be shown on the bus face in the appropriate colors instead of placing the logo separately. The reverse side of the sign may contain bus routing information.

To make the parking regulations more effective and to improve public relations by giving a definite warning, a sign reading TOW-AWAY ZONE (R7-201) may be appended to, or incorporated in, any parking prohibition sign. The Tow-Away Zone (R7-201a) symbol sign may be used instead of the R7-201 word message sign. The R7-201a sign may have either a black or red legend and border on a white background.

In rural areas, the legend NO PARKING ON PAVEMENT (R8-1) is generally suitable and may be used. If a roadway has paved shoulders, the NO PARKING EXCEPT ON SHOULDER sign (R8-2) may be used as it is less likely to cause confusion. The R8-3a symbol sign or the word message NO PARKING (R8-3) sign may be used to prohibit any parking along a given highway. Word message supplemental plaques, such as ON PAVEMENT (R8-3c) or ON BRIDGE (R8-3d), may be mounted below the R8-3 or R8-3a sign.

Section 2B.36 Placement of Parking, Stopping, and Standing Signs

Guidance:

When signs with arrows are used to indicate the extent of the restricted zones, the signs should be set at an angle of not less than 30 degrees nor more than 45 degrees with the line of traffic flow in order to be visible to approaching traffic.

Spacing of signs should be based on legibility and sign orientation.

If the zone is unusually long, signs showing a double arrow should be used at intermediate points within the zone.

Standard:

If the signs are mounted at an angle of 90 degrees to the curb line, two signs shall be mounted back to back at the transition point between two parking zones, each with the appended message THIS SIDE OF SIGN.

Guidance:

At intermediate points within a zone, a single sign without any arrow or appended plaque should be used, facing in the direction of approaching traffic. Otherwise the standards of placement should be the same as for signs using directional arrows.

Section 2B.37 Emergency Restriction Signs (R8-4, R8-7, R8-8)

Option:

The EMERGENCY PARKING ONLY (R8-4) sign or the EMERGENCY STOPPING ONLY (R8-7) sign may be used to discourage or prohibit shoulder parking, particularly where scenic or other attractions create a tendency for road users to stop temporarily, even though turnout or rest areas have not been provided.

The DO NOT STOP ON TRACKS (R8-8) sign may be used to discourage or prohibit parking or stopping on railroad tracks (see Section 8B.06).

Standard:

Emergency Restriction signs shall be rectangular and shall have a red or black legend and border on a white background.

Section 2B.38 WALK ON LEFT FACING TRAFFIC and No Hitchhiking Signs (R9-1, R9-4, R9-4a)

Option:

The WALK ON LEFT FACING TRAFFIC (R9-1) sign may be used on highways where no sidewalks are provided.

Standard:

If used, the WALK ON LEFT FACING TRAFFIC sign should be installed on the right side of the road where pedestrians walk on the pavement or shoulder in the absence of pedestrian pathways or sidewalks.

Option:

The No Hitchhiking (R9-4a) sign may be used to prohibit standing in or adjacent to the roadway for the purpose of soliciting a ride. The R9-4 word message sign may be used as an alternate to the R9-4a symbol sign.

Section 2B.39 Pedestrian Crossing Signs (R9-2, R9-3)

Option:

Pedestrian Crossing signs may be used to limit pedestrian crossing to specific locations.



R9-1



R9-2



R9-3a



R9-3b



R9-4



R9-4a



R10-1



R10-2a



R10-3



R10-3a

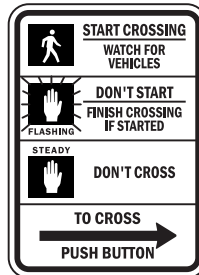

R10-3b



R10-3c



R10-4



R10-4a



R10-4b



R10-5

Standard:

If used, Pedestrian Crossing signs shall be installed to face pedestrian approaches.

Option:

Where crosswalks are clearly defined, the CROSS ONLY AT CROSSWALKS (R9-2) sign may be used to discourage jay-walking or unauthorized crossing.

The No Pedestrian Crossing (R9-3a) sign may be used to prohibit pedestrians from crossing a roadway at an undesirable location or in front of a school or other public building where a crossing is not designated.

The PEDESTRIANS PROHIBITED (R9-3) word message sign may be used as an alternate to the R9-3a symbol sign. The supplemental panel USE CROSSWALK (R9-3b), along with an arrow, may be installed below either sign to designate the direction of the crossing.

Support:

One of the most frequent uses of the Pedestrian Crossing signs is at signalized intersections that have three crossings that can be used and one leg that cannot be crossed.

Guidance:

The R9-3b sign should not be installed in combination with educational plaques.

Section 2B.40 Traffic Signal Signs (R10-1 through R10-13)

Option:

To supplement traffic signal control, Traffic Signal signs R10-1 through R10-13 may be used to regulate road users.

Guidance:

When used, Traffic Signal signs should be located adjacent to the signal face to which they apply.

Standard:

Traffic signal signs applicable to pedestrian actuation shall be mounted immediately above or incorporated in pedestrian pushbutton units (see Section 4E.07). Traffic Signal signs applicable to pedestrians include:

- A. CROSS ON GREEN LIGHT ONLY (R10-1),**
- B. CROSS ON WALK SIGNAL ONLY (R10-2),**
- C. PUSH BUTTON FOR GREEN LIGHT (R10-3), and**
- D. PUSH BUTTON FOR WALK SIGNAL (R10-4).**

Option:

The following signs may be used as an alternate for the R10-3 and R10-4 signs:

- A. TO CROSS STREET (arrow),
- B. PUSH BUTTON WAIT FOR GREEN LIGHT (R10-3a), and
- C. TO CROSS STREET (arrow) PUSH BUTTON WAIT FOR WALK SIGNAL (R10-4a).

The symbol sign R10-2a may be used as an alternate to sign R10-2. Where symbol-type pedestrian signal indications are used, an educational plaque (R10-3b) may be used to improve pedestrian understanding of pedestrian indications at signalized intersections. Where word-type pedestrian signal indications are being retained for the remainder of their useful service life, the legends WALK/DONT WALK may be substituted for the symbols on the educational plaque R10-3b, thus creating sign R10-3c. The diagrammatic sign R10-4b may also be used as an alternate to sign R10-4. At intersections where pedestrians cross in two stages using a median refuge island, the word message "CROSS TO MEDIAN" may be placed on the near corner of the refuge island along with the educational plaque.

Traffic Signal signs may be installed at certain locations to clarify signal control. Among the legends for this purpose are LEFT ON GREEN ARROW ONLY (R10-5), STOP HERE ON RED (R10-6 or R10-6a) for observance of stop lines, DO NOT BLOCK INTERSECTION (R10-7) for avoidance of traffic obstructions, USE LANE(S) WITH GREEN ARROW (R10-8) for obedience to Lane Control signals, and LEFT TURN YIELD ON GREEN (symbolic green ball) (R10-12).

Standard:

The NO TURN ON RED sign (R10-11a, R10-11b) shall be used to prohibit a right turn on red (or a left turn on red from a one-way street to a one-way street).

Guidance:

If used, the NO TURN ON RED sign should be installed near the appropriate signal head.

A NO TURN ON RED sign should be considered when an engineering study finds that one or more of the following conditions exists:



R10-6

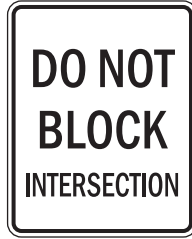

R10-7



R10-8

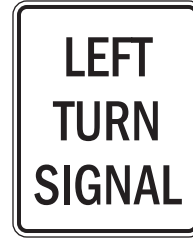

R10-10



R10-11a



R10-11b



R10-11c



R10-11d



R10-12



R10-13

- A. Inadequate sight distance to vehicles approaching from the left (or right, if applicable).
- B. Geometrics or operational characteristics of the intersection that might result in unexpected conflicts.
- C. An exclusive pedestrian phase.
- D. An unacceptable number of pedestrian conflicts with right-turn-on-red maneuvers, especially involving children, older pedestrians, or persons with disabilities.
- E. More than three right-turn-on-red accidents in a 12-month period have been reported for the particular approach.

When right turn on red is permitted and pedestrian crosswalks are marked, the word message TURNING TRAFFIC MUST YIELD TO PEDESTRIANS should be used.

Option:

A symbolic NO TURN ON RED sign (R10-11c or R10-11d) may be used as an alternate to the R10-11a and R10-11b signs.

In situations where traffic signals are coordinated for progressive timing, the Traffic Signal Speed sign (I1-1) may be used (see Section 2D.46).

Standard:

The EMERGENCY SIGNAL (R10-13) sign shall be used in conjunction with emergency-vehicle traffic control signals (see Section 4F.02).

Section 2B.41 KEEP OFF MEDIAN Sign (R11-1)

Option:

The KEEP OFF MEDIAN (R11-1) sign may be used to prohibit driving into or parking on the median.

Guidance:

The KEEP OFF MEDIAN sign should be installed on the left of the roadway within the median at random intervals as needed wherever there is a tendency for encroachment.



R11-1



R11-2



R11-3a

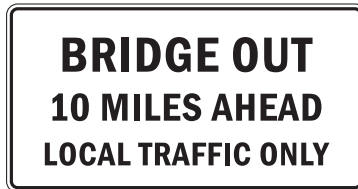

R11-3b



R11-4

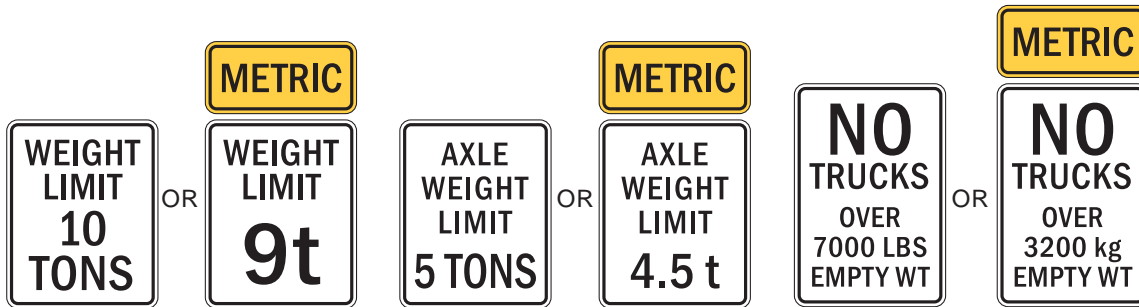

R12-1

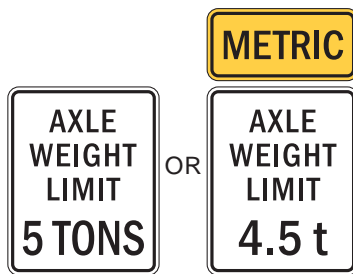

R12-2

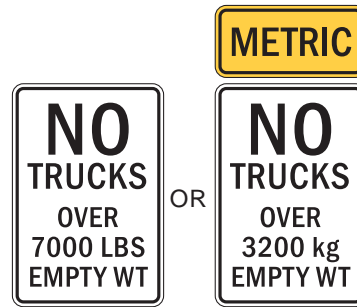

R12-3

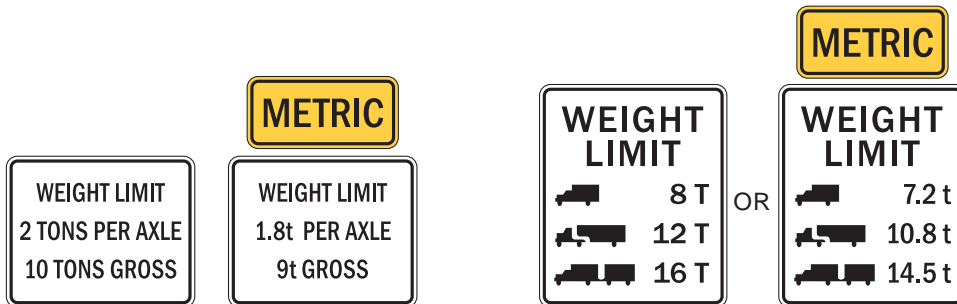

R12-4

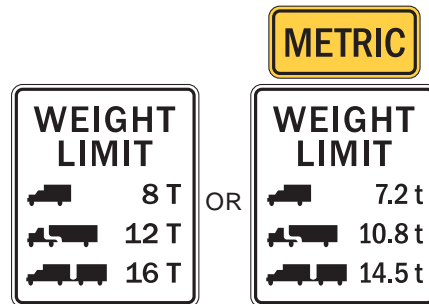

R12-5

Section 2B.42 ROAD CLOSED Sign (R11-2) and LOCAL TRAFFIC ONLY Signs (R11-3 Series, R11-4)

Guidance:

The ROAD CLOSED (R11-2) sign should be installed where roads have been closed to all traffic (except authorized vehicles).

ROAD CLOSED - LOCAL TRAFFIC ONLY (R11-3) and ROAD CLOSED TO THRU TRAFFIC (R11-4) signs should be used where through traffic is not permitted, or for a closure some distance beyond the sign, but where the highway is open for local traffic up to the point of closure.

Standard:

The Road Closed (R11-2, R11-3, and R11-4) signs shall be designed as horizontal rectangles. These signs shall be preceded by the applicable Advance Road Closed warning sign with the secondary legend AHEAD and, if applicable, an Advance Detour warning sign (see Section 6F.19).

Option:

The word message BRIDGE OUT may be substituted for the ROAD CLOSED message where applicable.

Section 2B.43 Weight Limit Signs (R12-1 through R12-5)

Option:

The Weight Limit (R12-1) sign carrying the legend WEIGHT LIMIT X t (XX TONS) may be used to indicate vehicle weight restrictions including load.

Where the restriction applies to axle weight rather than gross load, the legend may be AXLE WEIGHT LIMIT X t (XX TONS) or AXLE WEIGHT LIMIT XXXX kg (XXXX LBS) (R12-2).

To restrict trucks of certain sizes by reference to empty weight in residential districts, the legend may be NO TRUCKS OVER X t (XX TONS) EMPTY WT or NO TRUCKS OVER XXXX kg (XXXX LBS) EMPTY WT (R12-3).

In areas where multiple regulations of the type described above are applicable, a sign combining the necessary messages on a single panel may be used, such as WEIGHT LIMIT X t (XX TONS) PER AXLE, X t (XX TONS) GROSS (R12-4).

Posting of specific load limits may be accomplished by use of the Weight Limit symbol sign (R12-5). A sign containing the legend WEIGHT LIMIT on the top two lines, and showing three different truck symbols and their respective weight limits for which restrictions apply may be

used, with the weight limits shown to the right of each symbol as X t (XX T). A bottom line of legend stating GROSS WT may be included if needed for enforcement purposes.

Standard:

If used, the Weight Limit sign shall be located in advance of the applicable section of highway or structure.

Guidance:

If used, the Weight Limit sign with an advisory distance ahead legend should be placed at approach road intersections or other points where prohibited vehicles can detour or turn around.

Section 2B.44 Weigh Station Signs (R13 Series)

Guidance:

An ALL TRUCKS/COMMERCIAL VEHICLES NEXT RIGHT (R13-1) sign should be used to direct appropriate traffic into a weigh station.

The R13-1 sign should be supplemented by the D8 series of guide signs (see Section 2D.43).

Option:

The reverse color combination, a white legend and border on a black background, may be used for the R13-1 sign.

Section 2B.45 Truck Route Sign (R14-1)

Guidance:

The TRUCK ROUTE (R14-1) sign should be used to mark a route that has been designated to allow truck traffic.

Option:

On a numbered highway, the auxiliary TRUCK marker may be used (see Section 2D.20).



R13-1



R14-1



R14-2



R14-3

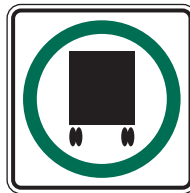

R14-4



14-5



R16-1

Section 2B.46 Hazardous Cargo Signs (R14-2, R14-3)**Option:**

The Hazardous Cargo Route (R14-2) sign may be used to identify routes that have been designated by proper authority for vehicles transporting hazardous cargo.

On routes where transporting of hazardous cargo is prohibited, the Hazardous Cargo Prohibition (R14-3) sign may be used.

Guidance:

If used, the Hazardous Cargo Prohibition sign should be installed on a street or roadway at a point where vehicles transporting hazardous cargo have the opportunity to take an alternate route.

Section 2B.47 National Network Signs (R14-4, R14-5)**Support:**

The signing of the National Network routes for trucking is optional.

Standard:

When a National Network route is signed, the National Network (R14-4) sign shall be used.

Option:

The National Network Prohibition (R14-5) sign may be used to identify routes, portions of routes, and ramps where trucks are prohibited. The R14-5 sign may also be used to mark the ends of designated routes.

Section 2B.48 Preferential Lane Signs (R3-10 through R3-17)**Support:**

Preferential lanes are lanes designated for special traffic uses such as high-occupancy vehicles (HOV), light rail, buses, taxis, or bicycles. Preferential lane treatments might be as simple as restricting a turning lane to a certain class of vehicles during peak periods, or as sophisticated as providing a separate roadway system within a highway corridor for certain vehicles.

GROUND-MOUNTED PREFERENTIAL LANE SIGNS



R3-10



R3-10a



R3-11a



R3-11b



R3-12



R3-12a

Note:

- The diamond symbol may be used instead of the word message HOV.
- The minimum vehicle occupancy requirement may vary for each facility (such as 2+, 3+, 4+).
- The occupancy requirement may be added to the first line of the R3-12, R3-12a, and R3-15a signs.

OVERHEAD PREFERENTIAL LANE SIGNS



R3-11



R3-13

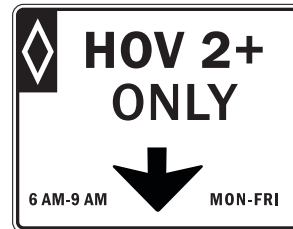

R3-14



R3-14a

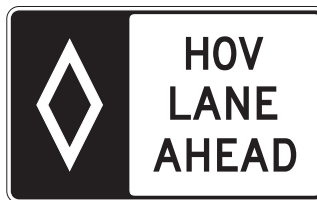

R3-15

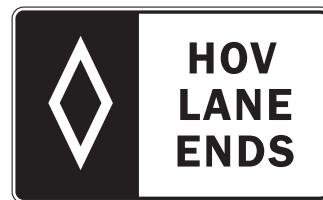

R3-15a

GROUND-MOUNTED BICYCLE LANE SIGNS



R3-16



R3-16a



R3-17



R3-17a

Option:

Preferential lane assignments may be made on a full-time or part-time basis.

Guidance:

Preferential Lane sign spacing should be determined by engineering judgment based on prevailing speed, block length, distances from adjacent intersections, and other considerations.

Support:

The symbol and word message that appears on a particular Preferential Lane sign will vary based on the specific type of allowed traffic and on other related operational constraints that have been established for a particular lane, such as an HOV lane, a bus lane, or a taxi lane.

Standard:

When a preferential lane is established, the Preferential Lane signs and pavement markings (see Section 3B.23) for these lanes shall be used to advise road users.

At the end of a preferential lane, a Lane Ends (R3-12a, R3-15a, or R3-16a) sign shall be used.

Guidance:

The R3-11 and R3-11a (ground-mounted) and R3-14 (overhead) signs should be used exclusively with preferential lanes for high-occupancy vehicles to indicate the particular vehicle occupancy requirement and time restrictions applying to that lane. The R3-11b (ground mounted) or R3-14a (overhead) word message signs should be used in situations where a preferential lane is not an HOV lane, but is designated exclusively for bus and/or taxi use.

When used, the R3-11, R3-11a, and R3-11b signs should be located adjacent to the preferential lane, and the R3-14 and R3-14a signs should be mounted directly over the lane.

The legend format of the ground-mounted High-Occupancy Vehicle Only (R3-11 series) signs should have the following sequence:

- A. Top Lines: Lanes applicable (for example, CENTER LANE, CURB LANE, RIGHT 2 LANES, THIS LANE)
- B. Middle Lines: HOV 2+ ONLY (lane occupancy requirement such as 2+, 3+, or 4+, or other applicable turning movements)

- C. Bottom Lines: Applicable time and day (for example, 7-9 AM, 4-6 PM, MON-FRI)

The legend format of the overhead High Occupancy Vehicle Only (R3-14) sign should have this sequence:

- A. Top Line: HOV 2+ (lane occupancy requirement such as 2+, 3+, or 4+, or other applicable turning movements)
- B. Bottom Lines: Applicable time and day, with the time and day separated by a down arrow (for example, 7-9 AM, 4-6 PM, MON-FRI)

Option:

The diamond symbol may be used instead of the word message HOV.

Guidance:

The diamond symbol on the HOV preferential lane signs (R3-11, R3-13, and R3-14) should appear in the top left quadrant. The diamond symbol should not be used on the bus, taxi, or bicycle preferential lane signs.

The Lane Ahead signs, R3-10, R3-10a, R3-12, R3-13, R3-15 and R3-16 should be used for advance notification of preferential lanes.

The R3-10 and R3-13 signs should be used in situations where agencies determine it is appropriate to provide a sign that defines the minimum occupancy requirement for a vehicle to use an HOV lane.

The legend format of the R3-10 and R3-13 signs should have this sequence:

- A. Top Line: HOV 2+ ONLY
- B. Bottom Lines: 2 OR MORE PERSONS PER VEHICLE

Changeable message signs serving as HOV signs should be the required sign size, and should display the required letter height and legend format that corresponds to the type of facility and design speed (see Section 2A.07).

Option:

Signs R3-11, R3-11a, R3-14, and R3-14a may be used to supplement overhead lane control signals or changeable message signs that are used to convey preferential lane restrictions.

Where additional movements are permitted from an HOV lane on an approach to an intersection, the middle line legend format may be modified to accommodate the permitted movements (for example, RIGHT TURNS ONLY) on the R3-11 and R3-14 signs.

Section 2B.49 High-Occupancy Vehicle (HOV) Lanes

Standard:

The agencies that own and operate High-Occupancy Vehicle (HOV) lanes shall have the authority and responsibility to determine how they are operated and the occupancy requirements for vehicles operating in HOV lanes. The minimum occupancy requirement shall be two occupants per vehicle.

The HOV signs shall display the minimum allowable vehicle occupancy requirement established for each HOV lane.

The vehicle occupancy requirement established for an HOV lane shall be referenced immediately after the word message HOV or the diamond symbol. The diamond symbol shall be restricted for use with HOV lanes only.

Motorcycles shall be eligible to use HOV lanes that received Federal-aid highway program funding.

The Federal Highway Administration (FHWA) shall be consulted if a significant operational change is proposed to specific HOV lane segments or to the entire HOV system, when it can be reasonably expected that the proposed change could affect HOV lane segments or portions of the HOV system that were funded or approved by FHWA. This shall include portions of the local, region, or federal-aid highway system, where operational changes might significantly impact the operation of one HOV lane or portions of the regional HOV system. To assure consistency with the provisions of Titles 23 and 49 of the United States Code (USC), the important issues and possible impacts of any significant changes shall be reviewed to determine if any Federal approval is required.

Support:

FHWA Division Offices, with input from the Federal Transit Administration (FTA), are responsible for reviewing proposals to significantly change the operation of HOV lanes. Federal interests in this review include commitments made during the National Environmental Policy Act process as described in Title 23 C.F.R., Part 771 in project agreements, transportation planning requirements, and transportation conformity requirements under the Clean Air Act (40 C.F.R., Part 51).

Proposals to adjust only the HOV lane hours of operation during the day (for example, minor changes in hours during peak travel periods) or the occupancy requirements (for example, HOV

3+ to HOV 2+) are not considered significant operational changes and do not require an explicit Federal review or approval.

Any proposal to significantly adjust the hours of operation or to convert an HOV lane to a general purpose lane is considered a significant change in the original project design concept or scope and does require a Federal review. Similarly, if the HOV lane is operational only during one peak travel period, any significant reduction in the hours of operation would be considered a significant change to the original project design concept or scope. Also, if an HOV lane is being managed and operated in a manner that renders it functionally inoperable or obsolete (for example, if no enforcement of occupancy requirement is provided), FHWA will consider that significant changes to the original project design concept or scope have occurred.

Guidance:

An engineering study based on the current and estimated future travel demand for a corridor and facility should be the basis for determining when, during a typical day, there should be a minimum occupancy requirement for a vehicle to use an HOV lane.

Option:

HOV lanes may be operated on a 24-hour basis for extended periods of the day, during peak travel periods only, during special events, or during other activities.

HOV lanes may take many forms depending on the level of usage and the design of the facility. They may be physically separated from the other travel lanes by a barrier or median, or they may be concurrent with other travel lanes and be separated only by longitudinal pavement markings. Physically-separated HOV lanes may be operated in a constant direction, or may be operated as reversible lanes.

Agencies may select from either the HOV abbreviation or the diamond symbol to reference the HOV lane designation.

Section 2B.50 High-Occupancy Vehicle Sign Applications and Placement

Standard:

Overhead HOV signs shall be located in advance of and at all entry points to barrier-separated HOV lanes. The overhead advance regulatory sign (R3-13 or R3-15) shall be used in advance of all barrier-separated HOV lanes. The overhead HOV sign (R3-14) shall be used at the beginning or entry point to all barrier-separated HOV lanes. Ground-mounted HOV regulatory signs (R3-10, R3-11 and R3-12) shall be used only as a supplement to overhead HOV signs (R3-13 and R3-14) in advance of and at the entry to barrier-separated HOV lanes.

For barrier-separated HOV lanes, the overhead HOV sign (R3-14) shall be used at all intermediate entry points or gaps in the barrier where vehicles are allowed to legally access the HOV lane. Ground-mounted HOV signs (R3-11) shall be located at intervals not greater than 400 m (0.25 mi) when intermediate entry points or gaps in the barrier exist to allow ingress or egress to the HOV lane.

For buffer-separated HOV lanes (painted buffer of 1.2 m (4 ft) or more), the overhead HOV sign (R3-14) shall be used at the initial and intermediate entry points or gaps in the buffer, where vehicles are allowed to legally access the HOV lane. Ground-mounted HOV signs (R3-11) shall be located at intervals not greater than 400 m (0.25 mi) between entry points. Overhead signs (R3-14) shall be used to supplement the ground-mounted HOV signs (R3-11) at intervals based on an engineering study.

For concurrent-flow HOV lanes, ground-mounted HOV signs (R3-11) shall be located at intervals not greater than 400 m (0.25 mi). Overhead HOV signs (R3-14) shall be used to supplement the ground-mounted HOV signs (R3-11) at intervals based on an engineering study.

For direct access ramps to HOV lanes, overhead HOV signs (R3-14) shall be used at the entry point to the ramp. Ground-mounted HOV signs (R3-11) shall be used only as a supplement to overhead HOV signs at direct access ramps.

Guidance:

For barrier-separated reversible-flow HOV lanes, HOV signs may be either static or changeable message type.

Section 2B.51 Other Regulatory Signs

Option:

Regulatory word message signs other than those classified and specified in this Manual and the "Standard Highways Sign" book may be developed to aid the enforcement of other laws or regulations.

Except for symbols on regulatory signs, minor modifications in the design may be permitted provided that the essential appearance characteristics are met.

Standard:

When a seat belt symbol is used, the R16-1 symbol shall be used.

Guidance:

The seat belt symbol should not be used alone but in connection with mandatory seat belt regulatory messages.

CHAPTER 2C. WARNING SIGNS

Section 2C.01 Function of Warning Signs

Support:

Warning signs call attention to unexpected conditions on or adjacent to a highway or street and to situations that might not be readily apparent to road users. Warning signs alert road users to conditions that might call for a reduction of speed or an action in the interest of safety and efficient traffic operations.

Section 2C.02 Application of Warning Signs

Standard:

The use of warning signs shall be based on an engineering study or on engineering judgment.

Guidance:

The use of warning signs should be kept to a minimum as the unnecessary use of warning signs tends to breed disrespect for all signs. In situations where the condition or activity is seasonal or temporary, the warning sign should be removed or covered when the condition or activity does not exist.

Support:

The application of warning signs can be classified into the categories shown in Table 2C-1. Warning signs specified herein cover most of the conditions that are likely to be encountered. Special warning signs for low-volume roads (as defined in Section 5A.01), temporary traffic control zones, school areas, highway-rail grade crossings, bicycle facilities, and highway-light rail transit grade crossings are discussed in Parts 5 through 10, respectively.

Option:

Word message warning signs other than those specified in this Manual may be developed and installed by State and local highway agencies.

Section 2C.03 Design of Warning Signs

Standard:

All warning signs shall be diamond-shaped (square with one diagonal vertical) with a black legend and border on a yellow background unless specifically designated otherwise. Warning signs shall be designed in accordance with the sizes, shapes, colors, and legends contained in the "Standard Highway Signs" book.

Table 2C-1. Application of Warning Signs

Category	Group	Section	Signs	MUTCD Codes	
Roadway Related	Changes in Horizontal Alignment	2C.06	Turn, Curve, Reverse Turn, Reverse Curve, Winding Road	W1-1 through W1-5	
		2C.07	Combination Horizontal Alignment/Advisory Speed	W1-9	
		2C.08	Combination Horizontal Alignment/Intersection	W1-10	
		2C.09	Large Arrow (one direction)	W1-6	
		2C.10	Chevron	W1-8	
	Vertical Alignment	2C.11	Hill	W7-1, W7-1a	
		2C.12	Truck Escape Ramp	W7-4, W7-4a	
		2C.13	Road Narrows	W5-1	
	Cross Section	2C.14-15	Narrow Bridge, One Lane Bridge	W5-2, W5-2a, W5-3	
		2C.16-18	Divided Road, Divided Road Ends, Double Arrow	W6-1, W6-2, W12-1	
		2C.19	Dead End, No Outlet	W14-1, W14-2	
		2C.20	Low Clearance	W12-2, W12-2P	
	Roadway Surface Condition	2C.21-22	Bump, Dip, Speed Hump	W8-1, W8-2, W17-1	
		2C.23	Pavement Ends	W8-3	
		2C.24	Shoulder	W8-4, W8-9, W8-11	
2C.25		Slippery When Wet	W8-5		
Traffic Related		Advance Traffic Control	2C.26	Stop Ahead, Yield Ahead, Signal Ahead	W3-1a, W3-2a, W3-3
	Traffic Flow	2C.28-32	Merge, Lane Reduction, Added Lane, Right Lane Ends, Lane Ends Merge Left, Two-Way Traffic, No Passing Zone	W4-1, W4-2, W4-3, W6-3, W9-1, W9-2, W14-3	
	Change in Speed	2C.27	Cross Traffic Does Not Stop	W4-4P	
		2C.33	Advisory Exit Speed	W13-2, W13-3, W13-5	
	Intersections	2C.34	Cross Road, Side Roads, T, Y, and Circular Intersection	W2-1 through W2-6	
		2C.35	Large Arrow (two directions)	W1-7	
	Motorized Traffic	2C.36	Trucks Crossing, Truck (symbol), Emergency Vehicle, Tractor	W8-6, W11-5, W11-8, W11-10	
	Non-Vehicular	Crossings	2C.37-38	Bicycle, Pedestrian, Deer, Cattle, Horse, Wheelchair, Playground, Diagonal Arrow	W11-1, W11-2, W11-3, W11-4, W11-7, W11-9, W15-1, W16-7P
	Supplemental Plaques	Distance	2C.41	XX Feet, XX Miles, Next XX FT, Next XX MI	W16-2, W16-3, W16-4, W7-3a
		Speed	2C.42	Advisory Speed	W13-1
Arrow		2C.43	Advance Arrow, Directional Arrow	W16-5P, W16-6P	
Hill-Related		2C.44	X% Grade, Trucks Use Low Gear	W7-2, W7-3	
Street Name Plaque		2C.45	Advance Street Name	W16-8	
Dead End/No Outlet		2C.46	Dead End, No Outlet	W14-1P, W14-2P	
Share the Road		2C.47	Share the Road	W16-1	

Option:

Warning signs regarding conditions associated with pedestrians, bicyclists, school buses, and schools may have a black legend and border on a yellow background or a black legend and border on a fluorescent yellow-green background.

Section 2C.04 Size of Warning Signs

Support:

Table 2C-2 is a listing of the sizes for warning signs.

Guidance:

The Conventional Road size should be used on conventional roads.

The Expressway and Freeway sizes should be used for higher-speed applications for increased recognition.

Option:

The Minimum size may be used on low-speed roadways where the reduced legend size would be adequate.

Oversized signs and larger sizes may be used where speed, volume, or other factors result in conditions where greater visibility or emphasis would be desirable.

Standard:

The minimum size for supplemental warning plaques shall be as shown in Table 2C-3.

Section 2C.05 Placement of Warning Signs

Standard:

Warning signs shall be installed in accordance with the general requirements for sign placement as described in Sections 2A.16 to 2A.21.

Support:

The total time needed to perceive and complete a reaction to a sign is the sum of the times necessary for Perception, Identification (understanding), Emotion (decision making), and Volition (execution of decision), and is called the PIEV time. The PIEV time can vary from several seconds for general warning signs to 6 seconds or more for warning signs requiring high road user judgment.

Table 2C-2. Warning Sign Sizes

Description		Conventional Roads	Express-ways	Freeways	Minimum	Oversized
Shape	Sign Series					
Diamond	W1, W2, W7, W8, W9, W11, W14, W15-1, W17-1	750 x 750 (30 x 30)	900 x 900 (36 x 36)	900 x 900 (36 x 36)	600 x 600 (24 x 24)	1200 x 1200 (48 x 48)
	W3, W4, W5, W6, W8-3, W10, W12	900 x 900 (36 x 36)	1200 x 1200 (48 x 48)	1200 x 1200 (48 x 48)	750 x 750 (30 x 30)	_____
Rectangular	W1 - Arrows	1200 x 600 (48 x 24)	_____	_____	900 x 450 (36 x 18)	1500 x 750 (60 x 30)
	W1- Chevron	450 x 600 (18 x 24)	750 x 900 (30 x 36)	900 x 1200 (36 x 48)	300 x 450 (12 x 18)	_____
	W7-4	1950 x 1200 (78 x 48)	_____	_____	_____	_____
	W7-4a	1950 x 1500 (78 x 60)	_____	_____	_____	_____
	W12-2P	2100 x 600 (84 x 24)	_____	_____	_____	_____
	W13	600 x 750 (24 x 30)	900 x 1200 (36 x 48)	1200 x 1500 (48 x 60)	600 x 750 (24 x 30)	1200 x 1500 (48 x 60)
Pennant	W14-3	900 x 1200 x 1200 (36 x 48 x 48)	_____	_____	750 x 1000 x 1000 (30 x 40 x 40)	1200 x 1600 x 1600 (48 x 64 x 64)
Circular	W10-1	450 (18) Dia.	_____	_____	375 (15) Dia.	600 (24) Dia.

Notes: 1. Larger signs may be used when appropriate

2. Dimensions are shown in millimeters followed by inches in parentheses and are shown as width x height

Table 2C-3. Minimum Size of Supplemental Warning Plaques

Size of Warning Sign	Size of Supplemental Plaque			
	Rectangular			Square
	1 Line	2 Lines	Arrow	
600 x 600 (24 x 24) 750 x 750 (30 x 30)	600 x 300 (24 x 12)	600 x 450 (24 x 18)	600 x 300 (24 x 12)	450 x 450 (18 x 18)
900 x 900 (36 x 36) 1200 x 1200 (48 x 48)	750 x 450 (30 x 18)	750 x 600 (30 x 24)	750 x 450 (30 x 18)	600 x 600 (24 x 24)

- Notes: 1. Larger supplemental plaques may be used when appropriate
 2. Dimensions are shown in millimeters followed by inches in parentheses and are shown as width x height

Table 2C-4 lists suggested sign placement distances for three conditions. This table is provided as an aid for determining warning sign location.

Guidance:

Warning signs should be placed so that they provide adequate PIEV time. The distances contained in Table 2C-4 are for guidance purposes and should be applied with engineering judgment. Warning signs should not be placed too far in advance of the condition, such that drivers might tend to forget the warning because of other driving distractions, especially in urban areas.

Minimum spacing between warning signs with different messages should be based on the estimated PIEV time for driver comprehension of and reaction to the second sign.

The effectiveness of the placement of warning signs should be periodically evaluated under both day and night conditions.

Option:

Warning signs that advise road users about conditions that are not related to a specific location, such as Deer Crossing or SOFT SHOULDER, may be installed in an appropriate location, based on engineering judgment, since they are not covered in Table 2C-4.

**Table 2C-4. Guidelines for Advance Placement of Warning Signs
(Metric Units)**

Posted or 85th- Percentile Speed (km/h)	Advance Placement Distance ¹									
	Condition A: High judgment required ²	Condition B: Stop condition ³	Condition C: Deceleration to the listed advisory speed (km/h) for the condition ⁴							
			10	20	30	40	50	60	70	80
30	50 m	N/A ⁵	N/A ⁵	N/A ⁵	—	—	—	—	—	—
40	70 m	N/A ⁵	25m	N/A ⁵	N/A ⁵	—	—	—	—	—
50	100 m	30 m	50 m	40 m	35 m	N/A ⁵	—	—	—	—
60	130 m	60 m	80 m	70 m	60 m	50 m	40 m	—	—	—
70	160 m	80 m	100 m	100 m	90 m	80 m	70 m	35 m	—	—
80	180 m	110 m	130 m	120 m	120 m	110 m	100 m	70 m	50 m	—
90	210 m	140 m	160 m	150 m	150 m	140 m	130 m	100 m	80 m	60 m
100	240 m	180 m	190 m	180 m	180 m	170 m	160 m	130 m	110 m	90 m
110	270 m	220 m	220 m	210 m	210 m	200 m	190 m	160 m	150 m	130 m
120	300 m	260 m	240 m	240 m	230 m	230 m	220 m	190 m	180 m	160 m
130	320 m	300 m	270 m	270 m	270 m	260 m	250 m	220 m	210 m	190 m

Notes:

¹ The distances are adjusted for a sign legibility distance of 50 m (175 ft) which is the appropriate legibility distance for a 125 mm (5 in) Series D word legend. The distances may be adjusted by deducting another 30 m (100 ft) if symbol signs are used. Adjustments may be made for grades if appropriate.

² Typical conditions are locations where the road user must use extra time to adjust speed and change lanes in heavy traffic because of a complex driving situation. Typical signs are Merge, Right Lane Ends, etc. The distances are determined by providing the driver a PIEV time of 6.7 to 10.0 seconds plus 4.5 seconds for vehicle maneuvers minus the legibility distance of 50 m (175 ft) for the appropriate sign.

³ Typical condition is the warning of a potential stop situation. Typical signs are Stop Ahead, Yield Ahead, or Signal Ahead. The distances are based on the 1990 AASHTO Policy for stopping sight distance (page 120) providing a PIEV time of 2.5 seconds, friction factor of 0.30 to 0.40, minus the sign legibility distance of 50 m (175 ft).

⁴ Typical conditions are locations where the road user must decrease speed to maneuver through the warned condition. Typical signs are Turn, Curve, or Cross Road. The distance is determined by providing a 1.6 second PIEV time (1990 AASHTO, page 119) a vehicle deceleration rate of 3 m/second² (10 ft/second²) minus the sign legibility distance of 50 m (175 ft).

⁵ No suggested minimum distances are provided for these speeds, as placement location is dependent on site conditions and other signing to provide an adequate advance warning for the driver.

**Table 2C-4. Guidelines for Advance Placement of Warning Signs
(English Units)**

Posted or 85th- Percentile Speed	Advance Placement Distance ¹						
	Condition A: High judgment required ²	Condition B: Stop condition ³	Condition C: Deceleration to the listed advisory speed (mph) for the condition ⁴				
			10	20	30	40	50
20 mph	175 ft	N/A ⁵	N/A ⁵	—	—	—	—
25 mph	250 ft	N/A ⁵	100 ft	N/A ⁵	—	—	—
30 mph	325 ft	100 ft	150 ft	100 ft	—	—	—
35 mph	400 ft	150 ft	200 ft	175 ft	N/A ⁵	—	—
40 mph	475 ft	225 ft	275 ft	250 ft	175 ft	—	—
45 mph	550 ft	300 ft	350 ft	300 ft	250 ft	N/A ⁵	—
50 mph	625 ft	375 ft	425 ft	400 ft	325 ft	225 ft	—
55 mph	700 ft	450 ft	500 ft	475 ft	400 ft	300 ft	N/A ⁵
60 mph	775 ft	550 ft	575 ft	550 ft	500 ft	400 ft	300 ft
65 mph	850 ft	650 ft	650 ft	625 ft	575 ft	500 ft	375 ft

Notes:

- ¹ The distances are adjusted for a sign legibility distance of 50 m (175 ft) which is the appropriate legibility distance for a 125 mm (5 in) Series D word legend. The distances may be adjusted by deducting another 30 m (100 ft) if symbol signs are used. Adjustments may be made for grades if appropriate.
- ² Typical conditions are locations where the road user must use extra time to adjust speed and change lanes in heavy traffic because of a complex driving situation. Typical signs are Merge, Right Lane Ends, etc. The distances are determined by providing the driver a PIEV time of 6.7 to 10.0 seconds plus 4.5 seconds for vehicle maneuvers minus the legibility distance of 50 m (175 ft) for the appropriate sign.
- ³ Typical condition is the warning of a potential stop situation. Typical signs are Stop Ahead, Yield Ahead, or Signal Ahead. The distances are based on the 1990 AASHTO Policy for stopping sight distance (page 120) providing a PIEV time of 2.5 seconds, friction factor of 0.30 to 0.40, minus the sign legibility distance of 50 m (175 ft).
- ⁴ Typical conditions are locations where the road user must decrease speed to maneuver through the warned condition. Typical signs are Turn, Curve, or Cross Road. The distance is determined by providing a 1.6 second PIEV time (1990 AASHTO, page 119) a vehicle deceleration rate of 3 m/second² (10 ft/second²) minus the sign legibility distance of 50 m (175 ft).
- ⁵ No suggested minimum distances are provided for these speeds, as placement location is dependent on site conditions and other signing to provide an adequate advance warning for the driver.

Sections 2C.06 Horizontal Alignment Signs (W1-1 through W1-5)**Option:**

The horizontal alignment Turn (W1-1), Curve (W1-2), Reverse Turn (W1-3), Reverse Curve (W1-4), or Winding Road (W1-5) signs may be used in advance of situations where the horizontal roadway alignment changes. A Large Arrow (W1-6) sign (see Section 2C.09) may be used on the outside of the turn or curve.

Guidance:

The application of these signs should conform to Table 2C-5.

Option:

An Advisory Speed plaque (see Section 2C.42) may be used to indicate the speed for the change in horizontal alignment. The supplemental distance plaque NEXT XX KM (NEXT XX MILES) may be installed below the Winding Road sign where continuous roadway curves exist (see Section 2C.41). The combination Horizontal Alignment/Advisory Speed sign (see Section 2C.07) or combination Horizontal Alignment/Intersection sign (see Section 2C.08) may also be used.

Standard:

When engineering judgment determines the need for a horizontal alignment sign, one of the W1-1 through W1-5 signs shall be used.

Section 2C.07 Combination Horizontal Alignment/Advisory Speed Sign (W1-9)**Option:**

The Turn (W1-1) sign or the Curve (W1-2) sign may be combined with the Advisory Speed (W13-1) plaque to create a combination Horizontal Alignment/Advisory Speed (W1-9) sign.

Standard:

When used, the combination Horizontal Alignment/Advisory Speed sign shall supplement other advance warning signs and shall be installed at the beginning of the turn or curve. The minimum size of the W1-9 sign shall be 1200 x 1200 mm (48 x 48 in) for high-speed facilities, and 900 x 900 mm (36 x 36 in) for low-speed facilities.



W1-1



W1-2



W1-3



W1-4



W1-5

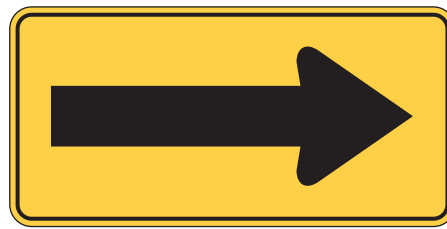

W1-6



W1-8



W1-9



W1-10

Table 2C-5. Horizontal Alignment Sign Usage

Number of Alignment Changes	Advisory Speed	
	≤ 30 MPH	> 30 MPH
1	Turn (W1-1) ¹	Curve (W1-2) ¹
2 ²	Reverse Turn ³ (W1-3)	Reverse Turn ³ (W1-4)
3 or more ²	Winding Road ³ (W1-5)	

Notes:

¹ Engineering judgment should be used to determine whether the Turn or Curve sign should be used.

² Alignment changes are in opposite directions and are separated by a tangent distance of 180 m (600 ft) or less.

³ A Right Reverse Turn (W1-3R), Right Reverse Curve (W1-4R), or Right Winding Road (W1-5R) sign is used if the first change in alignment is to the right; a Left Reverse Turn (W1-3L), Left Reverse Curve (W1-4L), or Left Winding Road (W1-5L) sign is used if the first change in alignment is to the left.

Section 2C.08 Combination Horizontal Alignment/Intersection Sign (W1-10)

Option:

The Turn (W1-1) sign or the Curve (W1-2) sign may be combined with the Cross Road (W2-1) sign or the Side Road (W2-2 or W2-3) sign to create a combination Horizontal Alignment/Intersection (W1-10) sign that depicts the condition where an intersection occurs within a turn or curve.

Guidance:

Elements of the combination Horizontal Alignment/Intersection sign related to horizontal alignment should conform to Section 2C.06, and elements related to intersection configuration should conform to Section 2C.34. No more than one Cross Road or two Side Road symbols should be shown on any one combination Horizontal Alignment/Intersection sign.

Section 2C.09 One-Direction Large Arrow Sign (W1-6)

Option:

A One-Direction Large Arrow (W1-6) sign may be used to delineate a change in horizontal alignment.

Standard:

The One-Direction Large Arrow sign shall be a horizontal rectangle with an arrow pointing to the left or right.

If used, the One-Direction Large Arrow sign shall be installed on the outside of a turn or curve in line with and at approximately a right angle to approaching traffic.

The One-Direction Large Arrow sign shall not be used where there is no alignment change in the direction of travel, such as at the beginnings and ends of medians or at center piers.

Guidance:

The One-Direction Large Arrow sign should be visible for a sufficient distance to provide the road user with adequate time to react to the change in alignment.

Section 2C.10 Chevron Alignment Sign (W1-8)**Option:**

The Chevron Alignment (W1-8) sign may be used to provide additional emphasis and guidance for a change in horizontal alignment. A Chevron Alignment sign may be used as an alternate or supplement to standard delineators on curves or to the Large Arrow (W1-6) sign.

Standard:

The Chevron Alignment sign shall be a vertical rectangle.

If used, Chevron Alignment signs shall be installed on the outside of a turn or curve, in line with and at approximately a right angle to approaching traffic.

Option:

A Chevron Alignment sign may be used on the far side of an intersection to inform drivers of a change of horizontal alignment through the intersection.

Guidance:

Spacing of Chevron Alignment signs should be such that the road user always has at least two in view, until the change in alignment eliminates the need for the signs.

Chevron Alignment signs should be visible for a sufficient distance to provide the road user with adequate time to react to the change in alignment.

Section 2C.11 Hill Signs (W7-1, W7-1a, W7-1b)**Guidance:**

The Hill (W7-1) sign should be used in advance of a downgrade where the length, percent of grade, horizontal curvature, and/or other physical features require special precautions on the part of road users.

The Hill sign and supplemental grade (W7-3) plaque (see Section 2C.45) used in combination, or the W7-1b sign used alone, should be installed in advance of downgrades for the following conditions:

- 5% grade that is more than 900 m (3,000 ft) in length
- 6% grade that is more than 600 m (2,000 ft) in length
- 7% grade that is more than 300 m (1,000 ft) in length
- 8% grade that is more than 225 m (750 ft) in length
- 9% grade that is more than 150 m (500 ft) in length

These signs should also be installed for steeper grades or where crash experience and field observations indicate a need.

Supplemental plaques (see Section 2C.44) and larger signs should be used for emphasis or where special hill characteristics exist. On longer grades, the use of the distance (W7-3a) plaque or the combination distance/grade (W7-3b) plaque at periodic intervals of approximately 1.6 km (1 mi) spacing should be considered.

Standard:

When the percent grade is shown, the message X% plaque shall be placed below the inclined ramp/truck symbol (W7-1) or the word message HILL (W7-1a) sign.

Option:

The word message HILL (W7-1a) sign may be used as an alternate to the symbol (W7-1) sign. The percent grade message may be included within these signs.

Section 2C.12 Truck Escape Ramp Signs (W7-4 Series)**Guidance:**

Where applicable, truck escape (or runaway truck) ramp advance warning signs should be located approximately 1.6 km (1 mi), and 0.8 km (0.5 mi) in advance of the grade, and of the ramp. A sign also should be placed at the gore. A regulatory sign with the legend RUNAWAY VEHICLES ONLY should be installed near the ramp entrance to



W7-1



W7-1a

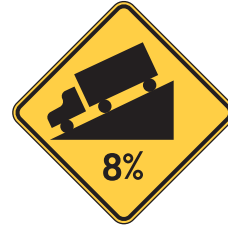

W7-1b



W7-4



W7-4b



W7-4c

discourage other road users from entering. No Parking (R8-3) signs should be placed near the ramp entrance.

Standard:

When truck escape ramps are installed, one of the W7-4 series signs shall be used.

Option:

A supplemental plaque may be used with the words SAND, GRAVEL, or PAVED to describe the ramp surface. State and local highway agencies may develop appropriate word message signs for the specific situation.

Section 2C.13 ROAD NARROWS Sign (W5-1)

Guidance:

A ROAD NARROWS (W5-1) sign should be used in advance of a transition on two-lane roads where the pavement width is reduced abruptly to a width such that vehicles might not be able to pass without reducing speed.

Option:

Additional emphasis may be provided by the use of object markers and delineators (see Chapters 3C and 3D). The Advisory Speed (W13-1) plaque (see Section 2C.42) may be used to indicate the recommended speed.

Section 2C.14 NARROW BRIDGE Sign (W5-2)

Guidance:

A NARROW BRIDGE (W5-2) sign should be used in advance of any bridge or culvert having a two-way roadway clearance width of 4.9 to 5.5 m (16 to 18 ft), or any bridge or culvert having a roadway clearance less than the width of the approach travel lanes.

Additional emphasis should be provided by the use of object markers, delineators, and/or pavement markings.

Option:

A NARROW BRIDGE sign may be used in advance of a bridge or culvert on which the approach shoulders are narrowed or eliminated.



W5-1



W5-2



W5-2a



W5-3



W6-1



W6-1a



W6-1b



W6-2



W6-2a



W12-1



W12-2

OR



W14-1



W14-2



OR



W12-2P

The Narrow Bridge (W5-2a) symbol sign may be used as an alternate to the word message NARROW BRIDGE sign.

Section 2C.15 ONE LANE BRIDGE Sign (W5-3)

Guidance:

A ONE LANE BRIDGE (W5-3) sign should be used on two-way roadways in advance of any bridge or culvert:

- A. Having a clear roadway width of less than 4.9 m (16 ft), or
- B. Having a clear roadway width of less than 5.5 m (18 ft) when commercial vehicles constitute a high proportion of the traffic, or
- C. If the sight distance is limited on the approach to a structure having a clear roadway width of 5.5 m (18 ft) or less.

Additional emphasis should be provided by the use of object markers, delineators, and/or pavement markings.

Section 2C.16 Divided Highway (Road) Sign (W6-1)

Guidance:

A Divided Highway (W6-1) symbol sign should be used on the approaches to a section of highway (not an intersection or junction) where the opposing flows of traffic are separated by a median or other physical barrier.

Option:

The word message DIVIDED HIGHWAY (W6-1a) or DIVIDED ROAD (W6-1b) sign may be used as an alternate to the symbol sign.

Section 2C.17 Divided Highway (Road) Ends Sign (W6-2)

Guidance:

A Divided Highway Ends (W6-2) symbol sign should be used at the end of a section of physically-divided highway (not an intersection or junction) as a warning of two-way traffic ahead.

Option:

The TWO-WAY TRAFFIC (W6-3) sign (see Section 2C.31) may be used to give warning and notice of the transition to a two-lane, two-way section.

The word message DIVIDED HIGHWAY ENDS (W6-2a) or DIVIDED ROAD ENDS (W6-2b) sign may be used as an alternate to the symbol sign.

Section 2C.18 Double Arrow Sign (W12-1)**Option:**

The Double Arrow (W12-1) sign may be used to advise road users that traffic is permitted to pass on either side of an island, obstruction, or gore in the roadway. Traffic separated by this sign may either rejoin or change directions.

Guidance:

If used on an island, the Double Arrow sign should be mounted near the approach end.

If used in front of a pier or obstruction, the Double Arrow sign should be mounted on the face of, or just in front of, the obstruction. Where stripe markings are used on the obstruction, they should be discontinued to leave a 75 mm (3 in) space around the outside of the sign.

Section 2C.19 DEAD END/NO OUTLET Signs (W14-1, W14-2)**Option:**

The DEAD END (W14-1) sign may be used at the entrance of a single road or street that terminates in a dead end or cul-de-sac. The NO OUTLET (W14-2) sign may be used at the entrance to a road or road network from which there is no other exit.

The DEAD END or NO OUTLET plaques (see Section 2C.46) may be used in combination with the Street Name (D3) sign (see Section 2D.38) at intersections instead of or in addition to the W14-1 or W14-2 signs.

Standard:

When the W14-1 or W14-2 sign is used, the sign shall be posted at the entry point or at a sufficient advance distance to permit the road user to avoid the dead end or no outlet condition by turning off, if possible, at the nearest intersecting street.

Section 2C.20 Low Clearance Signs (W12-2 and W12-2P)**Standard:**

The Low Clearance (W12-2) sign shall be used to warn road users of clearances less than 300 mm (12 in) above the statutory maximum vehicle height or minimum structure height.

Guidance:

The actual clearance should be shown on the Low Clearance sign to the nearest 25 mm (1 in) not exceeding the actual clearance. However, in areas that experience changes in temperature causing frost action, a reduction, not exceeding 75 mm (3 in), should be used for this condition.

Where the clearance is less than the legal limit, a sign to that effect should be placed at the nearest intersecting road or wide point in the road at which a vehicle can detour or turn around.

In the case of an arch or other structure under which the clearance varies greatly, two or more signs should be used as necessary on the structure itself to give information as to the clearances over the entire roadway.

Clearances should be evaluated periodically, particularly when resurfacing operations have occurred.

Option:

The Low Clearance sign may be installed on or in advance of the structure. If a sign is placed on the structure, it may be a rectangular shape (W12-2P) with the appropriate legend.

Section 2C.21 BUMP and DIP Signs (W8-1, W8-2)**Guidance:**

BUMP (W8-1) and DIP (W8-2) signs should be used to give warning of a sharp rise or depression in the profile of the road.

Option:

These signs may be supplemented with an Advisory Speed plaque (see Section 2C.42).



W8-1



W8-2



W8-3



W8-4



W8-5



W8-9



W8-9a



W8-11



W17-1



W3-1a



W3-2a



W3-3

Standard:

The DIP sign shall not be used at a short stretch of depressed alignment that may momentarily hide a vehicle.

Guidance:

A short stretch of depressed alignment that may momentarily hide a vehicle should be treated as a no-passing zone when centerline striping is provided on a two-lane road (see Section 3B.02).

Section 2C.22 SPEED HUMP Sign (W17-1)

Guidance:

The SPEED HUMP (W17-1) sign should be used to give warning of a vertical deflection in the roadway that is designed to limit the speed of traffic.

If used, the SPEED HUMP sign should be supplemented by an Advisory Speed plaque (see Section 2C.42).

Option:

If a series of speed humps exists in close proximity, an Advisory Speed plaque may be eliminated on all but the first SPEED HUMP sign in the series.

Section 2C.23 PAVEMENT ENDS Sign (W8-3)

Guidance:

A PAVEMENT ENDS (W8-3) word message sign should be used where a paved surface changes to either a gravel treated surface or an earth road surface.

Option:

An Advisory Speed plaque (see Section 2C.42) may be used when the change in roadway condition requires a reduced speed.

Section 2C.24 Shoulder Signs (W8-4, W8-9, W8-9a, and W8-11)**Support:**

The signs discussed in this Section are appropriate for use in temporary traffic control zones (see Part 6).

Standard:

When used in temporary traffic control zones, the sign legend and border shall be black on an orange background.

Option:

The SOFT SHOULDER (W8-4) word message sign may be used to warn of a soft shoulder condition.

The LOW SHOULDER (W8-9) word message sign may be used to warn of a shoulder condition where there is an elevation difference of less than 75 mm (3 in) between the shoulder and the travel lane.

Guidance:

The SHOULDER DROP-OFF (W8-9a) sign should be used during construction and maintenance when a shoulder drop-off exceeds 75 mm (3 in) in height.

The UNEVEN LANES (W8-11) word message sign should be used during construction and maintenance operations that create a substantial difference in elevation between adjacent lanes.

Additional shoulder signs should be placed at appropriate intervals along the road where the condition continually exists.

Standard:

When used, shoulder signs shall be placed in advance of the condition (see Table 2C-4).

Section 2C.25 Slippery When Wet Sign (W8-5)**Option:**

The Slippery When Wet (W8-5) sign may be used to warn that a slippery condition may exist.

Guidance:

When used, a Slippery When Wet sign should be placed in advance of the beginning of the affected section (see Table 2C-4), and additional signs should be placed at appropriate intervals along the road where the condition exists.

Section 2C.26 Advance Traffic Control Signs (W3-1, W3-2, W3-3, W3-4)**Standard:**

The Advance Traffic Control symbol signs include the Stop Ahead (W3-1a), Yield Ahead (W3-2a), and Signal Ahead (W3-3) signs. These signs shall be installed on an approach to a primary traffic control device that is not visible for a sufficient distance to permit the road user to respond to the device (see Table 2C-4). The visibility criteria for a traffic control signal shall be based on having a continuous view of at least two signal faces for the distance specified in Table 4D-1.

Support:

Permanent obstructions causing the limited visibility might include roadway alignment or structures. Intermittent obstructions might include foliage or parked vehicles.

Guidance:

Where intermittent obstructions occur, engineering judgment should determine the treatment to be implemented.

Option:

An Advance Traffic Control sign may be used for additional emphasis of the primary traffic control device, even when the visibility distance to the device is satisfactory.

Word messages (W3-1, W3-2, W3-3a) may be used as alternates to the Advance Traffic Control symbol signs.

A supplemental street name plaque (see Section 2C.45) may be installed above or below an Advance Traffic Control sign.

A warning beacon may be used with a Signal Ahead (W3-3) sign.

A BE PREPARED TO STOP (W3-4) sign may be used to warn of stopped traffic caused by traffic control signals or in areas that regularly experience traffic congestion.

Standard:

When a BE PREPARED TO STOP sign is used in advance of traffic signals, it shall be used in addition to a Signal Ahead sign.

Option:

The BE PREPARED TO STOP sign may be supplemented with beacons.

Guidance:

When the beacon is interconnected with a traffic control signal or queue detection system, the BE PREPARED TO STOP sign should be supplemented with a WHEN FLASHING plaque.

Section 2C.27 CROSS TRAFFIC DOES NOT STOP Plaque (W4-4P)

Option:

The CROSS TRAFFIC DOES NOT STOP (W4-4P) plaque may be used in advance of a STOP sign on approaches to two-way stop-controlled intersections to warn road users who might misinterpret the intersection as a four-way (or all-way) stop intersection. The W4-4P plaque may also be used in advance of a STOP sign on a one-way stop-controlled T-intersection.

In situations where this plaque is used to regulate traffic, the W4-4P plaque may be installed on the same post with the STOP sign.

Guidance:

If the W4-4P plaque is installed on the same post as the STOP sign, then the color of the plaque should be a black legend and border on a white background.

Option:

The arrow on the W4-4P plaque may point to the left, to the right, or in both directions.

Standard:

If the arrow points in a single direction, the arrow shall point in the direction from which the non-stopping traffic is approaching, and not in the direction that the non-stopping traffic is moving.



W4-1



W4-3



W6-3



W9-1



W9-2



W14-3



W4-4P

Section 2C.28 Merge Sign (W4-1)

Option:

A Merge (W4-1) sign may be used to warn road users on the major roadway that merging movements might be encountered in advance of a point where lanes from two separate roadways converge as a single traffic lane and no turning conflict occurs.

A Merge sign may also be installed on the side of the entering roadway to warn road users on the entering roadway of the merge condition.

Guidance:

The Merge sign should be installed on the side of the major roadway where merging traffic will be encountered and in such a position as to not obstruct the road user's view of entering traffic.

Where two roadways of approximately equal importance converge, a Merge sign should be placed on each roadway.

The Merge sign should not be used where two roadways converge and merging movements are not required.

The Merge sign should not be used in place of a Lane Ends (W4-2) sign where lanes of traffic moving on a single roadway must merge because of a reduction in the actual or usable pavement width (see Section 2C.30).

Section 2C.29 Added Lane Sign (W4-3)

Guidance:

The Added Lane (W4-3) sign should be installed in advance of a point where two roadways converge and merging movements are not required. When possible, the Added Lane sign should be placed such that it is visible from both roadways; if this is not possible, an Added Lane sign should be placed on the side of each roadway.

Section 2C.30 Lane Ends Signs (W9-1, W9-2)

Guidance:

The LANE ENDS MERGE LEFT (RIGHT) sign (W9-2) should be used to warn of the reduction in the number of traffic lanes in the direction of travel on a multi-lane highway.

Option:

The RIGHT (LEFT) LANE ENDS (W9-1) sign may be used in advance of the Lane Reduction (W4-2) sign or the LANE ENDS MERGE LEFT (RIGHT) (W9-2) sign as additional warning or to emphasize that the traffic lane is ending and that a merging maneuver will be required.

On one-way streets or on divided highways where the width of the median will permit, two Lane Ends signs may be placed facing approaching traffic, one on the right side and the other on the left side or median.

The reduction in traffic lanes may also be delineated with roadway edge lines (see Section 3B.09) and/or roadway delineation (see Chapter 3D).

Guidance:

Where an extra lane has been provided for slower moving traffic (see Section 2B.27), a Lane Ends sign should be installed in advance of the end of the extra lane.

Lane Ends signs should not be installed in advance of the end of an acceleration lane.

Section 2C.31 Two-Way Traffic Sign (W6-3)**Guidance:**

A Two-Way Traffic (W6-3) sign should be used to warn road users of a transition from a multi-lane divided section of roadway to a two-lane, two-way section of roadway.

Option:

The Two-Way Traffic sign may be used at intervals along a two-way roadway and may be used to supplement the Divided Highway (Road) Ends (W6-2) sign discussed in Section 2C.17.

Section 2C.32 NO PASSING ZONE Sign (W14-3)**Standard:**

The NO PASSING ZONE (W14-3) sign shall be a pennant-shaped isosceles triangle with its longer axis horizontal and pointing to the right. When used, the NO PASSING ZONE sign shall be installed on the left side of the roadway at the beginning of no-passing zones identified by either pavement markings or DO NOT PASS signs or both (see Sections 2B.24 and 3B.02).

Section 2C.33 Advisory Exit, Ramp, and Curve Speed Signs (W13-2, W13-3, W13-5)**Standard:**

Advisory Exit, Ramp, and Curve Speed signs shall be vertical rectangles.

The Exit Speed (W13-2), Ramp Speed (W13-3), or Curve Speed (W13-5) signs shall be used where engineering judgment indicates the need to advise road users of the recommended speed on an exit, a ramp, or a curve.

Guidance:

The Exit Speed sign should be used along the deceleration lane and the Ramp Speed sign should be used along the actual ramp since in some cases the ramp speed may be different from the deceleration exit speed.

The Exit Speed sign should be visible in time for the road user to make a safe slowing and exiting maneuver.

The Ramp Speed sign should be visible in time for the road user to reduce to the recommended speed.

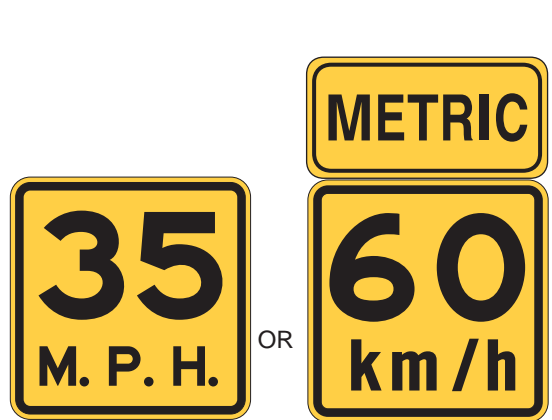
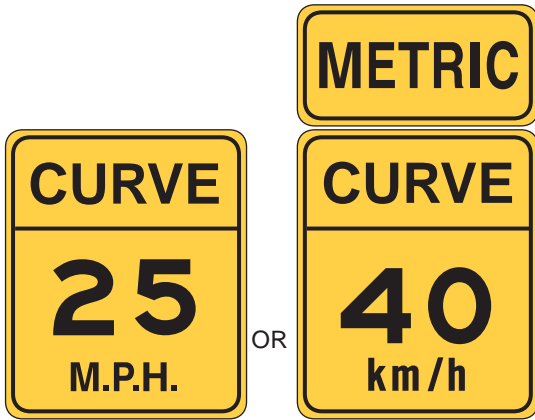
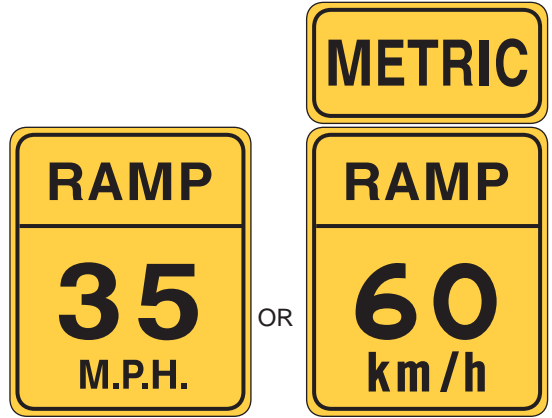
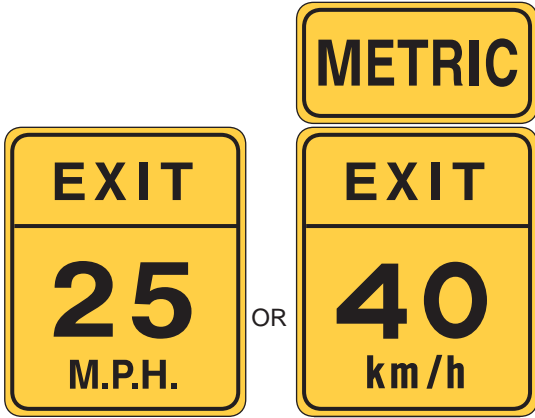

Option:

Additional Ramp Speed signs may be used beyond the gore and along the ramp where the recommended speed changes because of a change in curvature, or when there is a need to remind road users of the recommended speed. Based on engineering judgment, the Ramp Speed sign may be installed on the inside or outside of the curve to enhance its visibility.

A Curve Speed sign may be used beyond the beginning of a curve following a Horizontal Alignment and Advisory Speed sign combination where the recommended speed changes because of a change in curvature, or when there is a need to remind road users of the recommended speed.

Section 2C.34 Intersection Warning Signs (W2-1 through W2-6)**Option:**

A Cross Road (W2-1), Side Road (W2-2 or W2-3), T-Symbol (W2-4), or Y-Symbol (W2-5) sign may be used on a roadway, street, or shared-use path in advance of an intersection to indicate the presence of an intersection and the possibility of turning or entering traffic. The Circular Intersection (W2-6) sign accompanied by an educational word message plaque may be installed in advance of a circular intersection.

The relative importance of the intersecting roadways may be shown by different widths of lines in the symbol.

An advance street name plaque (see Section 2C.45) may be installed below an Intersection sign.

Guidance:

The Intersection sign should illustrate and depict the general configuration of the intersecting roadway, such as cross road, side road, T-intersection, Y-intersection, or curvilinear alignment.

Intersection signs should not be used on approaches controlled by STOP signs, YIELD signs, signals, or where Junction signing (see Sections 2D.13 and 2D.28) or advance route turn assembly signs (see Section 2D.29) are present.

Where the side roads are not opposite of each other, the symbol for the intersection should indicate a slight offset.



W2-1



W2-2



W2-3



W2-4



W2-5



W2-6

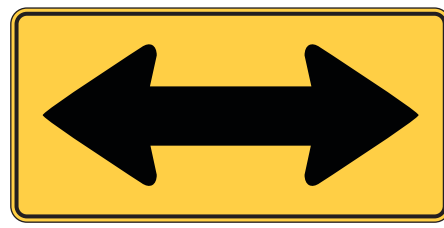

W1-7

Section 2C.35 Two-Direction Large Arrow Sign (W1-7)

Standard:

The Two-Direction Large Arrow (W1-7) sign shall be a horizontal rectangle.

If used, it shall be installed on the far side of a T-intersection in line with, and at approximately a right angle to, approaching traffic.

The Two-Direction Large Arrow sign shall not be used where there is no change in the direction of travel such as at the beginnings and ends of medians or at center piers.

Guidance:

The Two-Direction Large Arrow sign should be visible for a sufficient distance to provide the road user with adequate time to react to the intersection configuration.

Section 2C.36 Motorized Traffic Signs (W8-6, W11-5, W11-8, W11-10)**Option:**

Motorized Traffic (W8-6, W11-5, W11-8, or W11-10) signs may be used to alert road users to locations where unexpected entries into the roadway by trucks, farm vehicles, emergency vehicles, or other vehicles might occur.

Support:

These locations might be relatively confined or might occur randomly over a segment of roadway.

Guidance:

Motorized Traffic signs should be used only at locations where the road user's sight distance is restricted, or the condition, activity, or entering traffic would be unexpected.

If the condition or activity is seasonal or temporary, the Motorized Traffic sign should be removed or covered when the condition or activity does not exist.

Option:

Supplemental plaques (see Section 2C.39) with the legend AHEAD, XX METERS (XX FEET), or NEXT XX KILOMETERS (NEXT XX MILES) may be mounted below Motorized Traffic signs to provide advance notice to road users of unexpected entries.

Standard:

The Emergency Vehicle (W11-8) sign with the EMERGENCY SIGNAL AHEAD (W11-12P) supplemental plaque shall be placed in advance of all emergency-vehicle traffic control signals (see Chapter 4F).

Option:

The Emergency Vehicle (W11-8) sign, or a word message sign indicating the type of emergency vehicle (such as rescue squad), may be used in advance of the emergency vehicle station when no emergency-vehicle traffic control signal is present.

Section 2C.37 Crossing Signs (W11-1, W11-2, W11-3, W11-4, W16-7P)**Option:**

Crossing (W11-1 through W11-4) signs may be used to alert road users to locations where unexpected entries into the roadway by pedestrians, bicyclists, animals, and other crossing activities might occur.



W8-6



W11-5



W11-8



W11-10



W11-12P



W11-1



W11-2



W11-3



W11-4



W16-5P



W16-6P



W16-7P

Support:

These conflicts might be relatively confined, or might occur randomly over a segment of roadway.

Option:

Crossing signs may be supplemented with supplemental plaques (see Section 2C.39) with the legend AHEAD, XX METERS (XX FEET), or NEXT XX KILOMETERS (NEXT XX MILES) to provide advance notice to road users of crossing activity.

Standard:

Crossing signs shall be used adjacent to the crossing location. If the crossing location is not delineated by crosswalk pavement markings, the Crossing sign shall be supplemented with a diagonal downward pointing arrow plaque (W16-7P) showing the location of the crossing. If the crossing location is delineated by crosswalk pavement markings, the diagonal downward pointing arrow plaque shall not be required.

Option:

The crossing location may be defined with pavement markings (see Section 3B.17).

Pedestrian, Bicycle, School Advance Crossing, and School Crossing signs may have a fluorescent yellow-green background with a black legend and border.

Guidance:

When a fluorescent yellow-green background is used, a systematic approach featuring one background color within a zone or area should be used. The mixing of standard yellow and fluorescent yellow-green backgrounds within a selected site area should be avoided.

Crossing signs should be used only at locations where the crossing activity is unexpected or at locations not readily apparent.

Section 2C.38 Playground Sign (W15-1)**Option:**

The Playground (W15-1) sign may be used to give advance warning of a designated children's playground that is located adjacent to the road. The Playground sign may have a fluorescent yellow-green background with a black legend and border.



W16-1



W7-2



W7-2b



W7-3



W7-3b



W15-1



W16-8



W7-3a



W16-2



W16-2a



W16-3



W16-3a



W16-4



W14--1P



W14-2P

Guidance:

If the access to the playground area requires a roadway crossing, the application of crosswalk pavement markings (see Section 3B.17) and Crossing signs (see Section 2C.37) should be considered.

Section 2C.39 Use of Supplemental Plaques**Option:**

A supplemental plaque may be displayed with a warning sign when engineering judgment indicates that road users require additional information beyond that contained in the main message of the warning sign.

Standard:

Supplemental plaques shall be used only in combination with warning or regulatory signs. They shall not be mounted alone or displayed alone. If used, a supplemental plaque shall be installed on the same post(s) as the warning sign.

Section 2C.40 Design of Supplemental Plaques**Standard:**

A supplemental plaque shall have the same color legend, border, and background as the warning sign with which it is displayed. Supplemental plaques shall be square or rectangular.

Section 2C.41 Distance Plaques (W16-2, W16-3, W16-4, W7-3a)**Option:**

The Distance Ahead (W16-2 and W16-3) plaques may be used to inform the road user of the distance to the condition indicated by the warning sign.

The Next Distance (W16-4 and W7-3a) plaques may be used to inform road users of the length of roadway over which the condition indicated by the warning sign exists.

Section 2C.42 Advisory Speed Plaque (W13-1)**Option:**

The Advisory Speed (W13-1) plaque may be used to indicate the recommended speed for a condition.

Standard:

The Advisory Speed plaque shall carry the message XX km/h (XX M.P.H). The speed shown shall be a multiple of 10 km/h (5 mph).

Except in emergencies or when the condition is temporary, an Advisory Speed plaque shall not be installed until the recommended speed has been determined by an engineering study.

Guidance:

Because changes in conditions, such as roadway geometrics, surface characteristics, or sight distance, might affect the recommended speed, each location should be periodically evaluated and the Advisory Speed plaque changed if necessary.

Section 2C.43 Supplemental Arrow Plaques (W16-5P, W16-6P)**Guidance:**

If the condition indicated by a warning sign is located on an intersecting road and the distance between the intersection and condition is not sufficient to provide adequate advance placement of the warning sign, a Supplemental Arrow plaque (W16-5P, W16-6P) should be used below the warning sign.

Standard:

Supplemental Arrow plaques shall have the same legend design as the Advance Turn and Direction Arrow markers (see Sections 2D.25 and 2D.26) except that they shall have a black legend and border on a yellow or fluorescent yellow-green background, as appropriate.

Section 2C.44 Hill-Related Plaques (W7-2 and W7-3)**Guidance:**

Hill-Related (W7-2 series, W7-3 series) plaques (or other appropriate legends) and larger signs should be used for emphasis or where special hill characteristics exist.

On longer grades, the use of the distance plaque (W7-3a or W7-3b) at periodic intervals of approximately 1.6 km (1 mi) spacing should be considered.

Section 2C.45 Advance Street Name Plaque (W16-8)

Option:

An Advance Street Name (W16-8) plaque may be used with any Intersection sign (W2 series) or Advance Traffic Control (W3 series) sign to identify the name of the intersecting street.

Section 2C.46 DEAD END/NO OUTLET Plaques (W14-1P, W14-2P)

Option:

DEAD END (W14-1P) or NO OUTLET (W14-2P) plaques may be used in combination with Street Name (D3) signs (see Section 2D.38) at intersections instead of or in addition to the W14-1 or W14-2 signs.

Standard:

The DEAD END or the NO OUTLET plaque, as appropriate, shall be used where traffic can proceed straight through the intersection to the dead end or no outlet street.

Section 2C.47 SHARE THE ROAD Plaque (W16-1)

Option:

In situations where there is a need to warn drivers to watch for other slower forms of transportation traveling along the highway, such as bicycles, golf carts, or farm machinery, a SHARE THE ROAD (W16-1) plaque may be used.

CHAPTER 2D. GUIDE SIGNS - CONVENTIONAL ROADS

Section 2D.01 Scope of Conventional Road Guide Sign Standards

Standard:

Standards for conventional road guide signs shall apply to any road or street other than low-volume roads (as defined in Section 5A.01), expressways, and freeways.

Section 2D.02 Application

Support:

Guide signs are essential to direct road users along streets and highways, to inform them of intersecting routes, to direct them to cities, towns, villages, or other important destinations, to identify nearby rivers and streams, parks, forests, and historical sites, and generally to give such information as will help them along their way in the most simple, direct manner possible.

Chapter 2A addresses placement, location, and other general criteria for signs.

Section 2D.03 Color, Retroreflection, and Illumination

Support:

Requirements for illumination, retroreflection, and color are stated under the specific headings for individual guide signs or groups of signs. General provisions are given in Sections 2A.08, 2A.09, and 2A.11.

Standard:

Except where otherwise specified herein for individual signs or groups of signs, guide signs on streets and highways shall have a white message and border on a green background. All messages, borders, and legends shall be retroreflective and all backgrounds shall be retroreflective or illuminated.

Section 2D.04 Size of Signs

Support:

For most guide signs, the legends are so variable that a standardized size is not appropriate. The sign size is determined primarily by the length of the message, and the size of lettering and spacing necessary for proper legibility. However, for signs with standardized designs, such as

route signs, it is practical to use the standard sizes that are given in the "Standard Highway Signs" book.

Option:

Because the size of overhead signs are sometimes limited by factors such as lane width and vertical clearance, reduced letter height, reduced interline spacing, and reduced edge spacing may be used.

Guidance:

When a reduction in the standard size is necessary, the design used should be as similar as possible to the design for the standard size.

Section 2D.05 Lettering Style

Standard:

Design standards for upper-case letters, lower-case letters, capital letters, numerals, route shields, and spacing shall be as provided in the "Standard Alphabets for Highway Signs and Pavement Markings."

The standard lettering for conventional road guide signs shall be all capital letters (Section 2A.14), or a combination of lower-case letters with initial upper-case letters. When a combination of upper- and lower-case letters are used, the initial upper-case letters shall be approximately 1.33 times the "loop" height of the lower-case letters.

Section 2D.06 Size of Lettering

Support:

Sign legibility is a direct function of letter size and spacing. Legibility distance has to be sufficient to give road users enough time to read and comprehend the sign. Under optimum conditions, a guide sign message can be read and understood in a brief glance. The legibility distance includes a reasonable safety factor for inattention, blocking of view by other vehicles, unfavorable weather, inferior eyesight, or other causes for delayed or slow reading. Where conditions permit, repetition of guide information on successive signs gives the road user more than one opportunity to obtain the information needed.

Standard:

Design layouts for conventional road guide signs showing interline spacing, edge spacing, and other specification details shall be shown in the "Standard Highway Signs" book.

The principal legend on guide signs shall be in letters and numerals at least 150 mm (6 in) in height for all capital letters, or a combination of 150 mm (6 in) in height for upper-case letters with 113 mm (4.5 in) in height for lower-case letters. On low-volume roads (as defined in Section 5A.01), and on urban streets with speeds of 40 km/h (25 mph) or less, the principal legend shall be in letters at least 100 mm (4 in) in height.

Sign panels shall be large enough to accommodate the required legend without crowding.

Guidance:

Lettering sizes should be consistent on any particular class of highway.

The minimum lettering sizes specified herein should be exceeded where conditions indicate a need for greater legibility.

Section 2D.07 Amount of Legend

Support:

The longer the legend on a guide sign, the longer it will take road users to comprehend it, regardless of letter size.

Guidance:

Guide signs should be limited to three lines of principal legend. Where two or more signs are included in the same overhead display, the amount of legend should be minimized. The principal legend should include only place names, route numbers, and street names.

Option:

Symbols, action information, cardinal directions, and exit numbers may be used in addition to the principal legend where sign space is available.

Section 2D.08 Arrows

Support:

Arrows are used for lane assignment and to indicate the direction toward designated routes or destinations. Figure 2D-1 shows the up-arrow and the down-arrow designs that have been approved for use on guide signs. Detailed drawings of these standard arrows are shown in the "Standard Highway Signs" book.

Figure 2D-1. Arrows for Use on Guide Signs

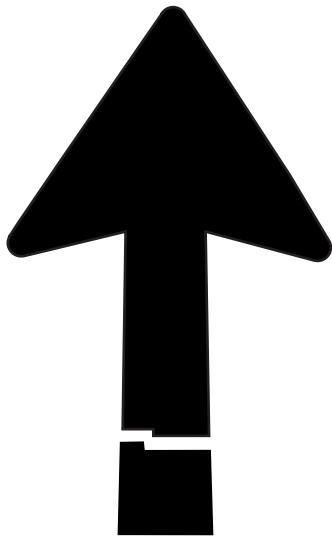

Up Arrow

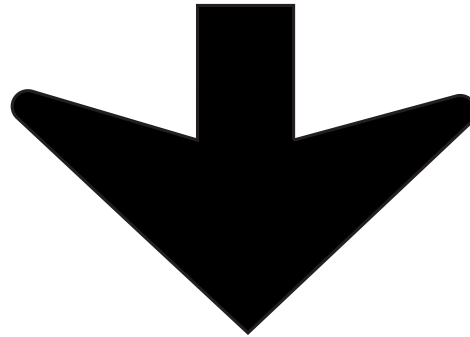

Down Arrow

Standard:

On overhead signs where it is desirable to indicate a lane to be followed, a down arrow shall point downward toward the center of that lane. Down arrows shall be used only on overhead guide signs that restrict the use of specific lanes to traffic bound for the destination(s) and/or route(s) indicated by these arrows. Down arrows shall not be used unless an arrow can be pointed to each lane that can be used to reach the destination shown on the sign.

Where a roadway is leaving the through lanes, an up arrow shall point upward at an angle representative of the alignment of the exit roadway.

Guidance:

Arrows used on guide signs to indicate the directions toward designated routes or destinations should be pointed at the appropriate angle to clearly convey the direction to be taken. A horizontally-oriented up-arrow design should be used at right-angle intersections.

On a ground-mounted guide sign, a directional arrow for a straight-through movement should point upward. For a turn, the arrow on a guide sign should point upward and at an angle related to the sharpness of the turn.

Option:

Arrows may be placed below the principal sign legend or on the appropriate side of the legend.

Guidance:

At an exit, an arrow should be placed at the side of the sign which will reinforce the movement of exiting traffic. The up-arrow design should be used.

The width across the arrow head should be at least equal to the height of the largest letter on the sign. For short downward pointing arrows on overhead signs, they should be 1.75 times the letter height.

Diagrammatic signing used on conventional roads should follow the principles set forth in Section 2E.19.

Section 2D.09 Numbered Highway Systems**Support:**

The purpose of numbering and signing highway systems is to identify routes and facilitate travel.

The Interstate and United States (U.S.) highway systems are numbered by the American Association of State Highway and Transportation Officials (AASHTO) upon recommendations of the State highway organizations because the respective States own these systems. State and county road systems are numbered by the appropriate authorities.

The basic policy for numbering the U.S. and Interstate highway systems is contained in the following Purpose and Policy statements published by AASHTO (see Page i for AASHTO's address):

- A. "Establishment and Development of United States Numbered Highways," and
- B. "Establishment of a Marking System of the Routes Comprising the National System of Interstate and Defense Highways."

Guidance:

The principles of these policies should be followed in establishing the above highway systems and any other systems, with effective coordination between adjacent jurisdictions. Care should be taken to avoid the use of numbers or other designations that have been assigned to Interstate, U.S., or State routes in the same geographic area. Overlapping numbered routes should be kept to a minimum.

Standard:

Route systems shall be given preference in this order: Interstate, United States, State, and County. The preference shall be given by installing the highest-priority legend on the top or the left of the sign panel.

Section 2D.10 Route Signs and Auxiliary Signs

Standard:

All numbered highway routes shall be identified by route signs and auxiliary signs.

The signs for each system of numbered highways, which are distinctive in shape and color, shall be used only on that system and the approaches thereto.

Route signs and any auxiliary signs that accompany them shall be retroreflective.

Option:

Route signs and auxiliary signs may be proportionally enlarged where greater legibility is needed.

Support:

Route signs are typically mounted in assemblies with auxiliary signs.

Section 2D.11 Design of Route Signs

Standard:

The "Standard Highway Signs" book shall be used for designing route signs. Other route sign designs shall be established by the authority having jurisdiction.

Interstate Route signs shall consist of a cutout shield, with the route number in white letters on a blue background, the word INTERSTATE in white capital letters on a red background, and a white border. This sign shall be used on all Interstate routes and in connection with route sign assemblies on intersecting highways.

A 600 x 600 mm (24 x 24 in) minimum sign size shall be used for Interstate route numbers with one or two digits, and a 750 x 600 mm (30 x 24 in) minimum sign size shall be used for Interstate route numbers having three digits.



Interstate Route Sign
M1-1



Off-Interstate Business Route Sign
M1-2 (Loop)
M1-3 (Spur)



U.S. Route Marker
M1-4



State Route Marker
M1-5



County Route Marker
M1-6



Forest Route Marker
M1-7

Option:

Interstate Route signs may contain the State name in white upper-case letters on a blue background.

Standard:

Off-Interstate Business Route signs shall consist of a cutout shield carrying the number of the connecting Interstate route and the words BUSINESS and either LOOP or SPUR in capital letters. The legend and border shall be white on a green background, and the shield shall be the same shape and dimensions as the Interstate Route sign. In no instance shall the word INTERSTATE appear on the Off-Interstate Business Route sign.

Option:

The Off-Interstate Business Route sign may be used on a major highway that is not a part of the Interstate system, but one that serves the business area of a city from an interchange on the system. When used on a green guide sign, a white square or rectangle may be placed behind the shield to improve contrast.

Standard:

U.S. Route signs shall consist of black numerals on a white shield surrounded by a black background without a border. This sign shall be used on all U.S. routes and in connection with route sign assemblies on intersecting highways.

A 600 x 600 mm (24 x 24 in) minimum sign size shall be used for U.S. route numbers with one or two digits, and a 750 x 600 mm (30 x 24 in) minimum sign size shall be used for U.S. route numbers having three digits.

State Route signs shall be designed by the individual State highway agencies.

Guidance:

State Route signs should be rectangular and should be approximately the same size as the U.S. Route sign. State Route signs should also be similar to the U.S. Route sign by containing approximately the same size black numerals on a white area surrounded by a black background without a border. The shape of the white area should be circular in the absence of any determination to the contrary by the individual State concerned.

Standard:

If County road authorities elect to establish and identify a special system of important County roads, County road identification signs shall be designed and used as specified in the publication, "A Proposal for a Uniform County Route

Marker Program on a National Scale" available from the National Association of Counties, 440 First Street, NW, Washington, DC 20001. County Route signs displaying two digits or the equivalent (letter and numeral, or two letters) shall be a minimum size of 450 x 450 mm (18 x 18 in); those carrying three digits or the equivalent shall be a minimum size of 600 x 600 mm (24 x 24 in).

If a jurisdiction uses letters instead of numbers to identify routes, all references to numbered routes in this Chapter shall be interpreted to also include lettered routes.

Guidance:

If used with other route signs in common assemblies, the County Route sign should be of a size compatible with that of the other route signs.

Option:

When used on a green guide sign, a yellow square or rectangle may be placed behind the County Route sign to improve contrast.

Standard:

Route signs for park and forest roads shall be designed with adequate distinctiveness and legibility and of a size compatible with other route signs used in common assemblies.

Section 2D.12 Design of Route Sign Auxiliaries

Standard:

Route sign auxiliaries carrying word legends, except the JCT sign, shall have a standard size of 600 x 300 mm (24 x 12 in). Those carrying arrow symbols, or the JCT sign, shall have a standard size of 525 x 375 mm (21 x 15 in). All route sign auxiliaries shall match the color combination of the route sign that they supplement.

Guidance:

Auxiliary signs carrying word messages and mounted with 750 x 600 mm (30 x 24 in) Interstate Route signs should be 750 x 375 mm (30 x 15 in). With route signs of larger sizes, auxiliary signs should be suitably enlarged, but not such that they exceed the width of the route sign.

Option:

A route sign and any auxiliary signs used with it may be combined on a single panel.

Section 2D.13 Junction Auxiliary Sign (M2-1)

Standard:

The Junction (M2-1) auxiliary sign shall carry the abbreviated legend JCT and shall be mounted at the top of an assembly (see Section 2D.27) either directly above the route sign or above a sign for an alternative route (see Section 2D.16) that is part of the route designation. The minimum size of the Junction auxiliary sign shall be 525 x 375 mm (21 x 15 in) for compatibility with auxiliary signs carrying arrow symbols.

Section 2D.14 Combination Junction Sign (M2-2)

Option:

As an alternative to the standard Junction assembly where more than one route is to be intersected or joined, a rectangular sign may be used carrying the word JUNCTION above the route numbers.

Other designs may be used to accommodate State and County Route signs.

Standard:

The Combination Junction (M2-2) sign shall have a green background with white border and lettering for the word JUNCTION.

Guidance:

Where U.S. or State Route signs are used as components of guide signs, only the outline of the shield or other distinctive shape should be used.

Although the size of the Combination Junction sign will depend on the number of routes involved, the numerals should be large enough for clear legibility, and should be of a comparable size with those in the individual route signs.



M2-1



M2-2



M3-1



M3-2



M3-3



M3-4



M4-1



M4-1a



M4-2



M4-3



M4-4



M4-5



M4-6



M4-7

Section 2D.15 Cardinal Direction Auxiliary Signs (M3-1 through M3-4)

Guidance:

Cardinal Direction auxiliary signs carrying the legend NORTH, EAST, SOUTH, or WEST should be used to indicate the general direction of the entire route.

Standard:

To improve the readability, the first letter of the cardinal direction words shall be ten percent larger, rounded up to the nearest whole number size.

If used, the Cardinal Direction auxiliary sign shall be mounted directly above a route sign or an auxiliary sign for an alternative route.

Section 2D.16 Auxiliary Signs for Alternative Routes (M4 Series)

Option:

Auxiliary signs, carrying legends such as ALTERNATE, BY-PASS, BUSINESS, or TRUCK, may be used to indicate an alternate route of the same number between two points on that route.

Standard:

If used, the auxiliary signs for alternative routes shall be mounted directly above a route sign.

Section 2D.17 ALTERNATE Auxiliary Signs (M4-1, M4-1a)

Option:

The ALTERNATE (M4-1) or the ALT (M4-1a) auxiliary sign may be used to indicate an officially designated alternate routing of a numbered route between two points on that route.

Standard:

If used, the ALTERNATE or ALT auxiliary sign shall be mounted directly above a route sign.

Guidance:

The shorter or better-constructed route should retain the regular route number, and the longer or worse-constructed route should be designated as the alternate route.

Section 2D.18 BY-PASS Auxiliary Sign (M4-2)

Option:

The BY-PASS (M4-2) auxiliary sign may be used to designate a route that branches from the numbered route through a city, bypasses a part of the city or congested area, and rejoins the numbered route beyond the city.

Standard:

If used, the BY-PASS auxiliary sign shall be mounted directly above a route sign.

Section 2D.19 BUSINESS Auxiliary Sign (M4-3)

Option:

The BUSINESS (M4-3) auxiliary sign may be used to designate an alternate route that branches from a numbered route, passes through the business portion of a city, and rejoins the numbered route beyond that area.

Standard:

If used, the BUSINESS auxiliary sign shall be mounted directly above a route sign.

Section 2D.20 TRUCK Auxiliary Sign (M4-4)

Option:

The TRUCK (M4-4) auxiliary sign may be used to designate an alternate route that branches from a numbered route, when it is desirable to encourage or require commercial vehicles to use the alternate route.

Standard:

If used, the TRUCK auxiliary sign shall be mounted directly above a route sign.

Section 2D.21 TO Auxiliary Sign (M4-5)

Option:

The TO (M4-5) auxiliary sign may be used to provide directional guidance to a particular road facility from other highways in the vicinity (see Section 2D.32).

Standard:

If used, the TO auxiliary sign shall be mounted directly above a route sign or an auxiliary sign for an alternative route.

Section 2D.22 END Auxiliary Sign (M4-6)

Guidance:

The END (M4-6) auxiliary sign should be used where the route being traveled ends, usually at a junction with another route.

Standard:

If used, the END auxiliary sign shall be mounted either directly above a route sign, or above a sign for an alternative route that is part of the designation of the route being terminated.

Section 2D.23 TEMPORARY Auxiliary Sign (M4-7)

Option:

The TEMPORARY (M4-7) auxiliary sign may be used for an interim period to designate a section of highway that is not planned as a permanent part of a numbered route, but that connects completed portions of that route.

Standard:

If used, the TEMPORARY auxiliary sign shall be mounted either directly above the route sign, above a Cardinal Direction sign, or above a sign for an alternate route that is a part of the route designation.

TEMPORARY auxiliary signs shall be promptly removed when the temporary route is abandoned.

Section 2D.24 Temporary Detour and Auxiliary Signs

Support:

Chapter 6F contains information regarding Temporary Detour and Auxiliary signs.

Section 2D.25 Advance Turn Arrow Auxiliary Signs (M5-1, M5-2)**Standard:**

If used, the Advance Turn Arrow auxiliary sign shall be mounted directly below the route sign in Advance Route Turn assemblies, and displays a right or left arrow, the shaft of which is bent at a 90-degree angle (M5-1) or at a 45-degree angle (M5- 2).

Section 2D.26 Directional Arrow Auxiliary Signs (M6 Series)**Standard:**

If used, the Directional Arrow auxiliary sign shall be mounted below the route sign in directional assemblies, and displays a single- or double-headed arrow pointing in the general direction that the route follows.

Section 2D.27 Route Sign Assemblies**Standard:**

A Route Sign assembly shall consist of a route sign and auxiliary signs that further identify the route and indicate the direction. Route Sign assemblies shall be installed on all approaches to numbered routes that intersect with other numbered routes.

Where two or more routes follow the same section of highway, the route signs for Interstate, U.S., State, and County routes shall be mounted in that order from the left in horizontal arrangements and from the top in vertical arrangements. Subject to this order of precedence, route signs for lower-numbered routes shall be placed at the left or top.

Within groups of assemblies, information for routes intersecting from the left shall be mounted at the left in horizontal arrangements and at the top or center of vertical arrangements. Similarly, information for routes intersecting from the right shall be at the right or bottom, and for straight-through routes at the center in horizontal arrangements or top in vertical arrangements.

Route Sign assemblies shall be mounted in accordance with the general specifications for highway signs (Chapter 2A), with the lowest sign in the assembly at the height prescribed for single signs.

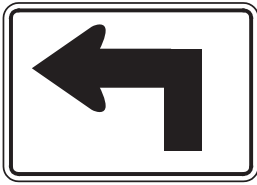

M5-1

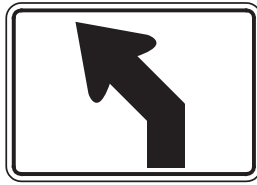

M5-2

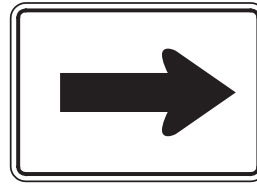

M6-1

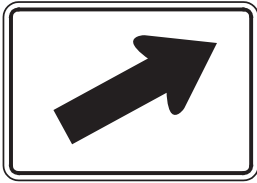

M6-2



M6-3

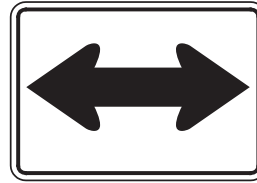

M6-4



M6-5

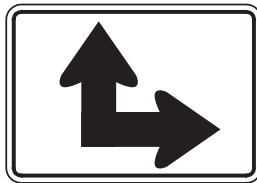

M6-6

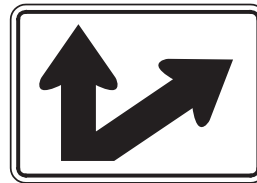

M6-7



M6-8

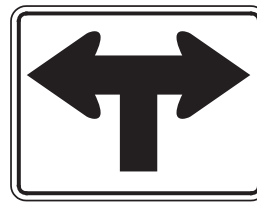

M6-9

Guidance:

Assemblies for two or more routes, or for different directions on the same route, should be mounted in groups on a common support.

Option:

Route Sign assemblies may be installed on the approaches to numbered routes on unnumbered roads and streets that carry an appreciable amount of traffic destined for the numbered route.

If engineering judgment indicates that groups of assemblies that include overlapping routes or multiple turns might be confusing, route signs or auxiliary signs may be omitted or combined, provided that clear directions are given to road users.

Support:

Figure 2D-2 shows typical placements of route signs.

Section 2D.28 Junction Assembly**Standard:**

A Junction assembly shall consist of a Junction auxiliary sign and a route sign. The route sign shall carry the number of the intersected or joined route.

The Junction assembly shall be installed in advance of every intersection where a numbered route is intersected or joined by another numbered route. In urban areas it shall be installed in the block preceding the intersection, and in rural areas it shall be installed at least 120 m (400 ft) in advance of the intersection. In rural areas, the minimum distance between the Destination sign and the Route Turn assembly shall be 60 m (200 ft), and the minimum distance between the Route Turn assembly and the Junction assembly shall be 60 m (200 ft).

Guidance:

In urban areas where speeds are low, the Junction assembly should not be installed more than 90 m (300 ft) in advance of the intersection.

Where prevailing speeds are high, greater spacings should be used.

Figure 2D-2. Illustration of Directional Assemblies and Other Route Signs (For One Direction of Travel Only) (Sheet 1 of 3)

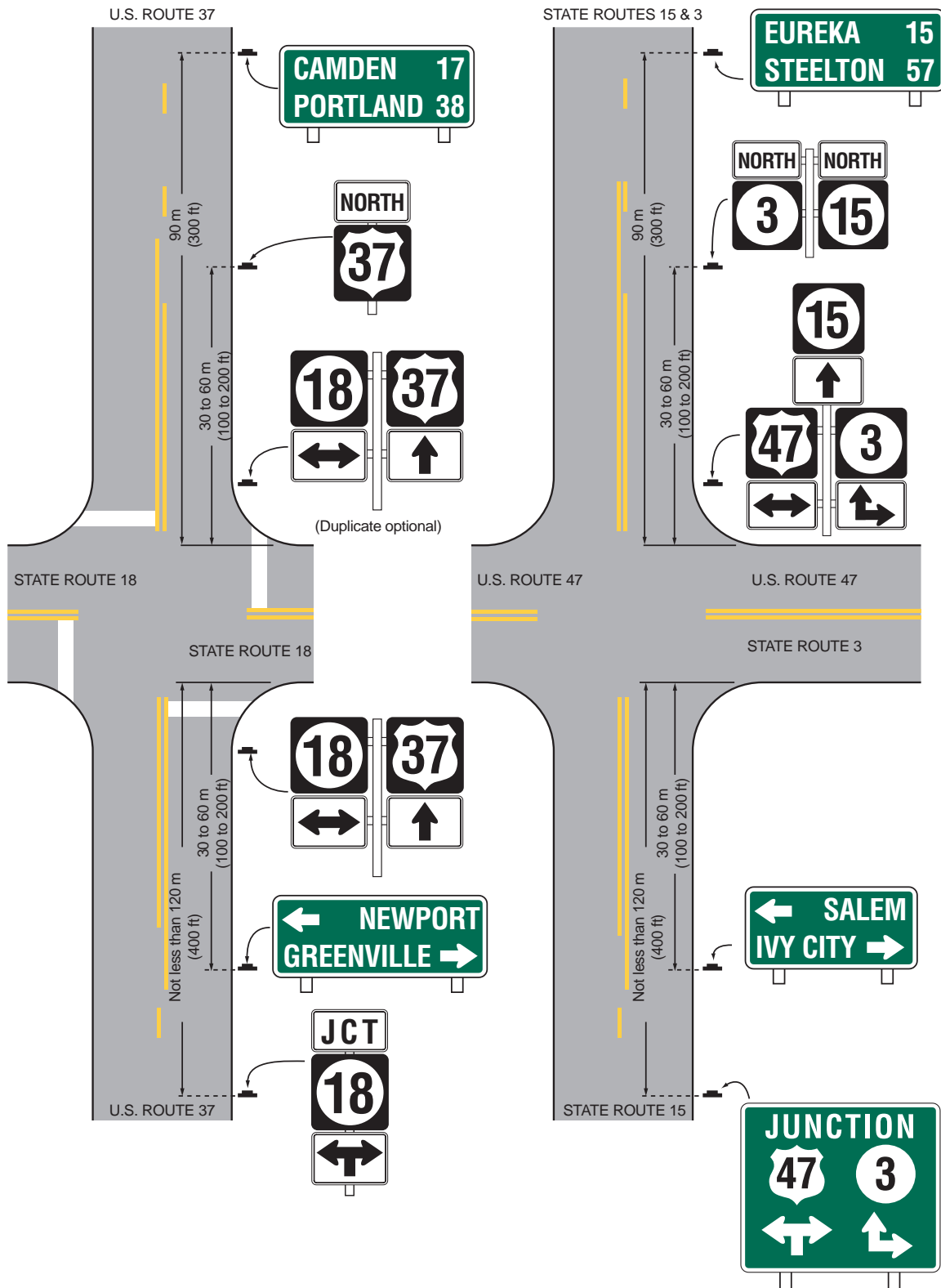

Figure 2D-2. Illustration of Directional Assemblies and Other Route Signs (For One Direction of Travel Only) (Sheet 2 of 3)

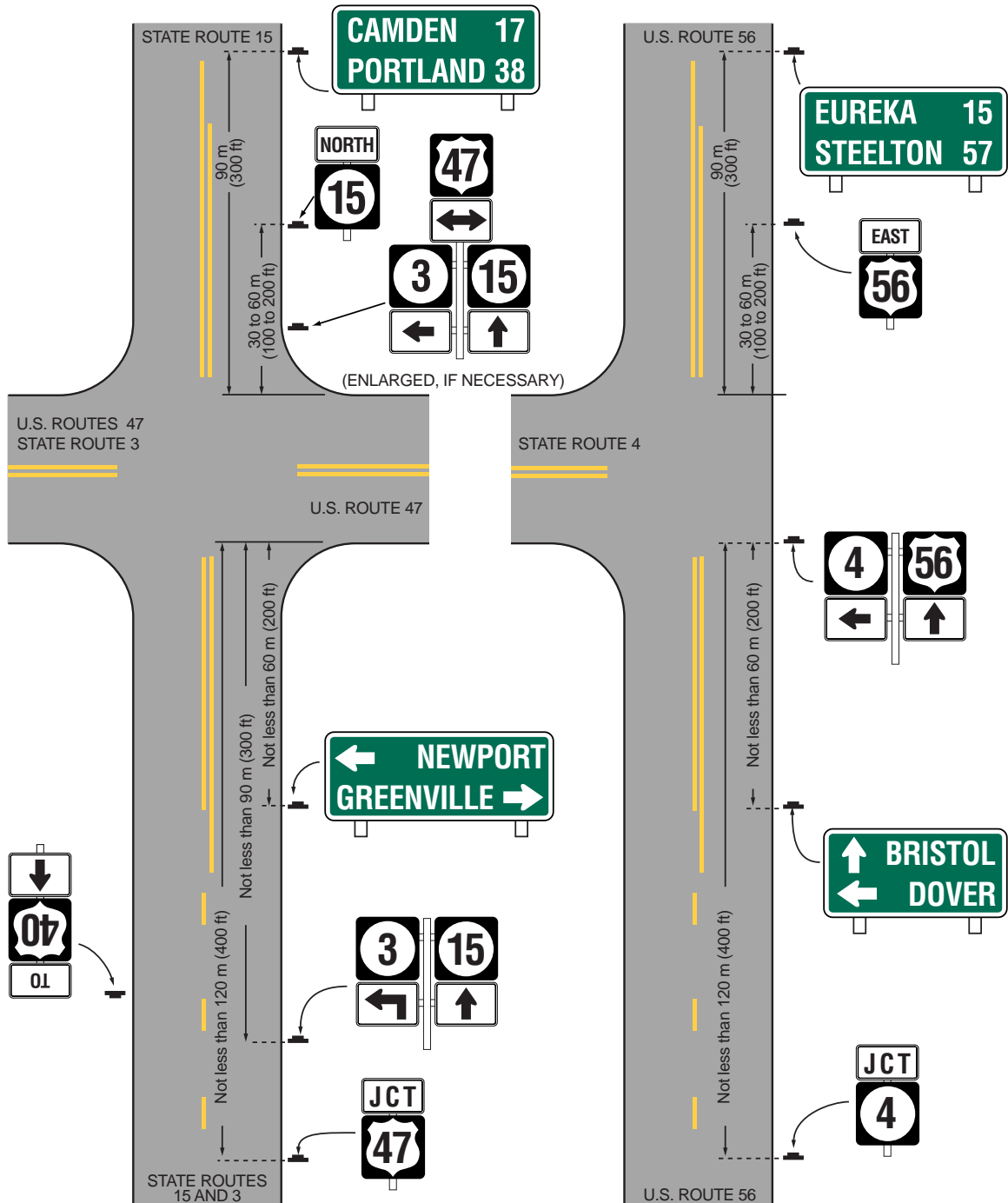
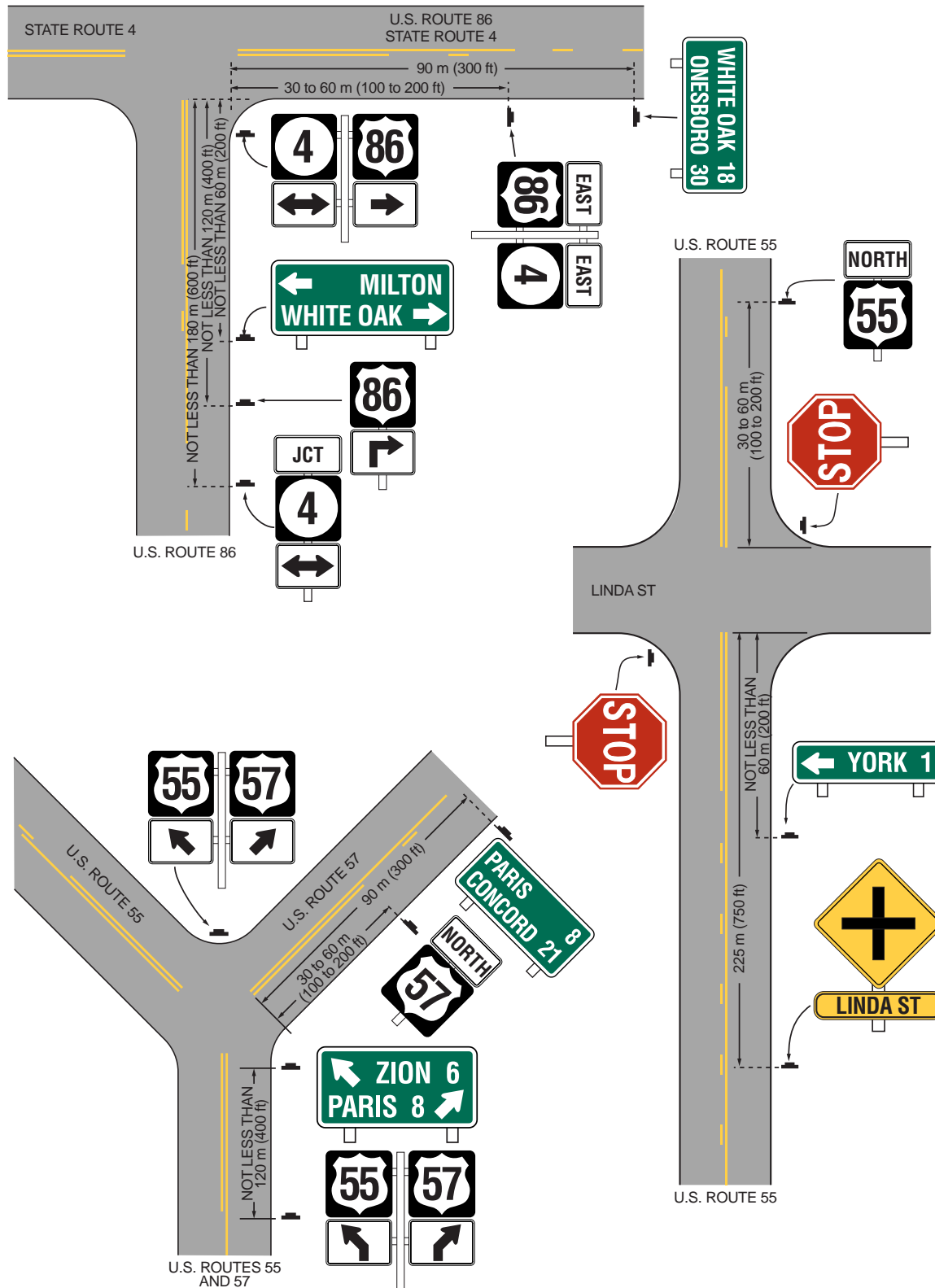

Figure 2D-2. Illustrations of Directional Assemblies and Other Route Signs (For One Direction of Travel Only) (Sheet 3 of 3)



Option:

Where two or more routes are to be indicated, a single Junction auxiliary sign may be used for the assembly and all route signs grouped in a single mounting, or a Combination Junction sign (see Section 2D.14) may be used.

Section 2D.29 Advance Route Turn Assembly**Standard:**

An Advance Route Turn assembly shall consist of a route sign, an Advance Turn Arrow or word message auxiliary sign, and a Cardinal Direction auxiliary sign, if needed. It shall be installed in advance of an intersection where a turn must be made to remain on the indicated route.

Option:

The Advance Route Turn assembly may be used to supplement the required Junction assembly in advance of intersecting routes.

Guidance:

Where a multiple-lane highway approaches an interchange or intersection with a numbered route, the Advance Route Turn assembly should be used to pre-position turning vehicles in the correct lanes from which to make their turn.

In low-speed areas, the Advance Route Turn assembly should be installed not less than 60 m (200 ft) in advance of the turn. In high-speed areas, the Route Turn assembly should be installed not less than 90 m (300 ft) in advance of the turn.

Standard:

An assembly that includes an Advance Turn Arrow auxiliary sign shall not be placed where there is an intersection between it and the designated turn.

Guidance:

Sufficient distance should be allowed between the assembly and any preceding intersection that could be mistaken for the indicated turn.

Section 2D.30 Directional Assembly**Standard:**

A Directional assembly shall consist of a route sign, a Directional Arrow auxiliary sign, and a Cardinal Direction auxiliary sign, if needed. The various uses of Directional assemblies shall be as outlined below:

- A. Turn movements (indicated in advance by an Advance Route Turn assembly) shall be marked by a Directional assembly with a route sign displaying the number of the turning route and a single-headed arrow pointing in the direction of the turn.**
- B. The beginning of a route (indicated in advance by a Junction assembly) shall be marked by a Directional assembly with a route sign displaying the number of that route and a single-headed arrow pointing in the direction of the route.**
- C. The end of a route shall be marked by a Directional assembly with an END auxiliary sign and a route sign displaying the number of that route.**
- D. An intersected route (indicated in advance by a Junction assembly) shall be designated by:**
 - 1. Two Directional assemblies, each with a route sign displaying the number of the intersected route, a Cardinal Direction auxiliary sign, and a single-headed arrow pointing in the direction of movement on that route; or**
 - 2. A Directional assembly with a route sign displaying the number of the intersected route and a double-headed arrow, pointing at appropriate angles to the left, right, or ahead.**

Guidance:

Straight-through movements should be indicated by a Directional assembly with a route sign displaying the number of the continuing route and a vertical arrow. A Directional assembly should not be used for a straight-through movement in the absence of other assemblies indicating right or left turns, as the Confirming assembly sign beyond the intersection normally provides adequate guidance.

Directional assemblies should be located on the near right corner of the intersection. At major intersections and at Y or offset intersections, additional Directional assemblies should be installed on the far right or left corner to confirm the near-side assemblies. When the near-corner position is not practical for Directional assemblies, the far right corner should be the preferred alternative, with oversized signs, if necessary, for

legibility. Where unusual conditions exist, the location of a Directional assembly should be determined by engineering judgment with the goal being to provide the best possible combination of view and safety.

Support:

It is more important that guide signs be readable at the right time and place than to be located with absolute uniformity.

Figure 2D-2 shows typical placements of Directional assemblies.

Section 2D.31 Confirming or Reassurance Assemblies

Standard:

If used, Confirming or Reassurance assemblies shall consist of a Cardinal Direction auxiliary sign and a route sign.

If used, the Confirming assembly shall be installed just beyond intersections of numbered routes.

Guidance:

If the Confirming assembly is used, it should be placed 7.6 to 60 m (25 to 200 ft) beyond the far shoulder or curb line of the intersected highway.

If used, reassurance assemblies should be installed between intersections in urban districts as needed, and beyond the built-up area of any incorporated city or town.

Route signs for either confirming or reassurance purposes should be spaced at such intervals as necessary to keep road users informed of their routes.

Section 2D.32 Trailblazer Assembly

Support:

Trailblazer assemblies provide directional guidance to a particular road facility from other highways in the vicinity. This is accomplished by installing Trailblazer assemblies at strategic locations to indicate the direction to the nearest or most convenient point of access. The use of the word TO indicates that the road or street where the sign is posted is not a part of the indicated route, and that a road user is merely being directed progressively to the route.

Standard:

A Trailblazer assembly shall consist of a TO auxiliary sign, a route sign (or a special road facility symbol), and a single-headed Directional Arrow auxiliary sign pointing in the direction leading to the route.

Option:

A Cardinal Direction auxiliary sign may be used with a trailblazer assembly.

Guidance:

The TO auxiliary sign, Cardinal Direction auxiliary sign, and Directional Arrow auxiliary sign should be of the standard size specified for auxiliary signs of their respective type. The route sign should be the size specified in Section 2D.11.

Option:

Trailblazer assemblies may be installed with other Route Sign assemblies, or alone, in the immediate vicinity of the designated facilities.

Section 2D.33 Destination and Distance Signs

Support:

In addition to guidance by route numbers, it is desirable to supply the road user information concerning the destinations that can be reached by way of numbered or unnumbered routes. This is done by means of Destination signs and Distance signs.

Option:

Route and Cardinal Direction auxiliary signs may be included on the Destination sign panel with the destinations and arrows.

Guidance:

The size of the route signs and Cardinal Direction auxiliary signs should be at least the minimum size specified for these signs.

Section 2D.34 Destination Signs**Standard:**

Except where special interchange signing is prescribed, the Destination sign, if used, shall be a horizontal rectangle carrying the name of a city, town, village, or other traffic generator, and a directional arrow.

Option:

The distance to the place named may also be shown. If several destinations are to be shown at a single point, the several names may be placed on a single panel with an arrow (and the distance, if desired) for each name. If more than one destination lies in the same direction, a single arrow may be used for such a group of destinations.

Guidance:

Adequate separation should be made between any destinations or group of destinations in one direction and those in other directions by suitable design of the arrow, spacing of lines of legend, heavy lines entirely across the panel, or separate panels.

Standard:

An arrow pointing to the right shall be at the extreme right of the sign, and an arrow pointing left or up shall be at the extreme left. The distance figures, if used, shall be placed to the right of the destination names.

Guidance:

The directional arrows should be horizontal or vertical, but at an irregular intersection a sloping arrow will sometimes convey a clearer indication of the direction to be followed.

If several individual name panels are assembled into a group, all panels in the assembly should be of the same length.

Destination signs should be used:

- A. At the intersections of U.S. or State numbered routes with Interstate, U.S., or State numbered routes.
- B. At points where they serve to direct traffic from U.S. or State numbered routes to the business section of towns, or to other destinations reached by unnumbered routes.



D1-1



D1-2



D1-3



D1-1a



D1-2a



D1-3a



D2-1



D2-2



D2-3

Standard:

Where a total of three or less destinations are provided on the Advance Guide (see Section 2E.30) and Supplemental Guide (see Section 2E.32) signs, not more than three destination names shall be used on a Destination sign. Where four destinations are provided by the Advance Guide and Supplemental Guide signs, not more than four destination names shall be used on a Destination sign.

Guidance:

If space permits, four destinations should be displayed as two separate sign panels.

Option:

Where space does not permit, or where all four destinations are in one direction, a single sign assembly may be used.

Standard:

Where a single four-name sign assembly is used, a heavy line entirely across the panel or separated sign panels shall be used to separate destinations by direction.

Guidance:

The next closest destination lying straight ahead should be at the top of the sign or assembly, and below it the closest destinations to the left and to the right, in that order. The destination shown for each direction should ordinarily be the next county seat or the next principal city, rather than a more distant destination. In the case of overlapping routes, there should be shown only one destination in each direction for each route.

Standard:

If there is more than one destination shown in the same direction, the name of the nearest destination shall appear above the name of any destinations that are further away.

Section 2D.35 Location of Destination Signs

Guidance:

When used in high-speed areas, Destination signs should be located 60 m (200 ft) or more in advance of the intersection, and following any Junction or Advance Route Turn assemblies that may be required.

Option:

In urban areas, shorter advance distances may be used.

Because the Destination sign is of lesser importance than the Junction, Advance Route Turn, or Directional assemblies, the Destination sign may be eliminated when sign spacing is critical.

Support:

Figure 2D-2 shows typical placements of Destination signs.

Section 2D.36 Distance Signs**Standard:**

If used, the Distance sign shall be a horizontal rectangle of a size appropriate for the required legend, carrying the names of not more than three cities, towns, junctions, or other traffic generators, and the distance (to the nearest kilometer or mile) to those places.

Guidance:

The top name on the Distance sign should be that of the next place on the route having a post office or a railroad station, a route number or name of an intersected highway, or any other significant geographical identity. The bottom name on the sign should be that of the next major destination or control city. If three destinations are shown, the middle line should be used to indicate communities of general interest along the route or important route junctions.

Option:

The choice of names for the middle line may be varied on successive Distance signs to give road users additional information concerning communities served by the route.

Guidance:

The control city should remain the same on all successive Distance signs throughout the length of the route until that city is reached.

Option:

If more than one distant point may properly be designated, such as where the route divides at some distance ahead to serve two destinations of similar importance, and if these two

destinations cannot appear on the same sign, the two names may be alternated on successive signs.

On a route continuing into another state, destinations in the adjacent state may be shown.

Section 2D.37 Location of Distance Signs

Guidance:

If used, Distance signs should be installed on important routes leaving municipalities, and just beyond intersections of numbered routes in rural areas. If used, they should be placed just outside the municipal limits, or at the edge of the built-up district if it extends beyond the limits.

Where overlapping routes separate a short distance from the municipal limits, the Distance sign at the municipal limits should be omitted. The Distance sign should be installed approximately 90 m (300 ft) beyond the separation of the two routes.

Where, just outside of an incorporated municipality, two routes are concurrent and continue concurrently to the next incorporated municipality, the top name on the Distance sign should be that of the place where the routes separate; the bottom name should be that of the city to which the greater part of the through traffic is destined.

Support:

Figure 2D-2 shows typical placements of Distance signs.

Section 2D.38 Street Name Sign (D3)

Guidance:

Street Name (D3) signs should be installed in urban areas at all street intersections regardless of other route signs that may be present, and should be installed in rural areas to identify important roads that are not otherwise signed.

Lettering on Street Name signs should be at least 150 mm (6 in) high in capital letters or 150 mm (6 in) upper-case letters with 110 mm (4.5 in) lower-case letters. Larger letter heights should be used for street name signs mounted overhead.

Option:

For local roads with speed limits of 40 km/h (25 mph) or less, the lettering height may be a minimum of 100 mm (4 in).



D3



D4-1



D4-2

Supplementary lettering to indicate the type of street (such as Street, Avenue, or Road) or the section of the city (such as NW) may be in smaller lettering, at least 75 mm (3 in) high. Conventional abbreviations (see Section 1A.14) may be used except for the street name itself.

A symbol or letter designation may be used to identify the governmental jurisdiction.

Standard:

If a symbol or letter designation is used, the width of the symbol or letter designation shall not exceed the letter height of the sign.

Guidance:

The symbol or letter designation should be positioned to the left of the street name.

Standard:

The Street Name sign shall be retroreflective or illuminated to show the same shape and similar color both day and night. The legend and background shall be of contrasting colors.

Guidance:

Street Name signs should have a white legend on a green background. A border, if used, should be the same color as the legend.

In business districts and on principal arterials, Street Name signs should be placed at least on diagonally opposite corners so that they will be on the far right side of the intersection for traffic on the major street. In residential areas, at least one Street Name sign should be mounted at each intersection. Signs naming both streets should be installed at each intersection. They should be mounted with their faces parallel to the streets they name.

Option:

Street name signs may be installed at both midblock and intersection locations. To optimize visibility, Street Name signs may be mounted overhead. On intersection approaches, a supplemental Street Name sign (see Section 2C.45) may be installed separately or below an intersection-related warning sign. Street Name signs may also be placed above a regulatory or STOP sign with no required vertical separation.

At intersection crossroads where the same road has two different street names for each direction of travel, both street names may be shown on the same sign along with directional arrows.

Guidance:

When combined with a warning sign, the color of the supplemental Street Name sign should be a black message and border on a yellow background.

Section 2D.39 Parking Area Sign (D4-1)**Option:**

The Parking Area (D4-1) sign may be used to show the direction to a nearby public parking area.

Standard:

If used, the sign shall be a horizontal rectangle with a standard size of 750 x 600 mm (30 x 24 in), or with a smaller size of 450 x 375 mm (18 x 15 in) for minor, low-speed streets. It shall carry the word PARKING, with the letter P five times the height of the remaining letters, and a directional arrow. The legend and border shall be green on a retroreflectorized white background.

Guidance:

If used, the Parking Area sign should be installed on major thoroughfares at the nearest point of access to the parking facility and where it can advise drivers of a place to park. The sign should not be used more than four blocks from the parking area.

Section 2D.40 PARK & RIDE Sign (D4-2)**Option:**

PARK & RIDE (D4-2) signs may be used to direct road users to park and ride facilities.

Standard:

The signs shall contain the word message PARK & RIDE and direction information (arrow or word message).

Option:

PARK & RIDE signs may contain the local transit logo and/or carpool symbol within the sign border.

Standard:

If used, the local transit logo and/or carpool symbol shall be located in the top part of the sign above the message PARK & RIDE. In no case shall the vertical dimension of the local transit logo and/or carpool symbol exceed 450 mm (18 in).

Guidance:

If the function of the parking facility is to provide parking for persons using public transportation, the local transit logo symbol should be used on the guide sign. If the function of the parking facility is to serve carpool riders, the carpool symbol should be used on the guide sign. If the parking facility serves both functions, both the logo and carpool symbol should be used.

Standard:

These signs shall have a retroreflective white legend and border on a rectangular green background. The carpool symbol shall be as shown for sign D4-2. The color of the transit logo shall be selected by the local transit authority.

Option:

To increase the target value and contrast of the transit logo, and to ensure that the local transit logo retains its distinctive color and shape, the logo may be included within a white border or placed on a white background.

Section 2D.41 Rest Area Signs (D5 Series)**Standard:**

Rest Area signs shall be used only where parking and restroom facilities are available. Signs for this purpose shall have retroreflective white letters, symbols and border on a blue background.

Guidance:

If used, Rest Area signs should be installed in advance of roadside parks or rest areas to permit the driver to reduce speed and leave the highway safely.

Option:

Messages such as REST AREA X km (X MILE) (D5-1), REST AREA (D5-2), PARKING AREA X km (X MILE) (D5-3), PARKING AREA (D5-4), ROADSIDE TABLE X km (X MILE) (D5-5), ROADSIDE PARK X km (X MILE), and PICNIC TABLE X km (X MILE) may be used, as well as other appropriate messages.



D5-1



D5-2



D5-3



D5-4



D5-5



D5-5a



D6-1



D6-2



D6-3

Section 2D.42 Scenic Area Signs (D6 Series)**Option:**

Scenic areas may be marked by signs carrying the message SCENIC AREA, SCENIC VIEW, SCENIC OVERLOOK, or the equivalent, together with appropriate directional information.

Guidance:

The design of the signs should be consistent with that specified for rest areas in Section 2D.41 and should be white letters, symbols, and border on a blue background. An advance sign and an additional sign at the turnoff point should be used for this kind of attraction.

Section 2D.43 Weigh Station Signing (D8 Series)**Support:**

The general concept for Weigh Station signing is similar to Rest Area signing (see Section 2D.41) because in both cases traffic using either area remains within the right-of-way.

Standard:

The standard installation for Weigh Station signing shall include three basic signs:

- A. Advance sign (D8-1)**
- B. Exit Direction sign (D8-2)**
- C. Gore sign (D8-3)**

Support:

The typical locations of these signs are shown in Figure 2D-3.

Option:

Where State law requires a regulatory sign (R13-1) in advance of the Weigh Station, a fourth sign (Section 2B.44) may be located following the Advance sign.

Figure 2D-3. Typical Weigh Station Signing

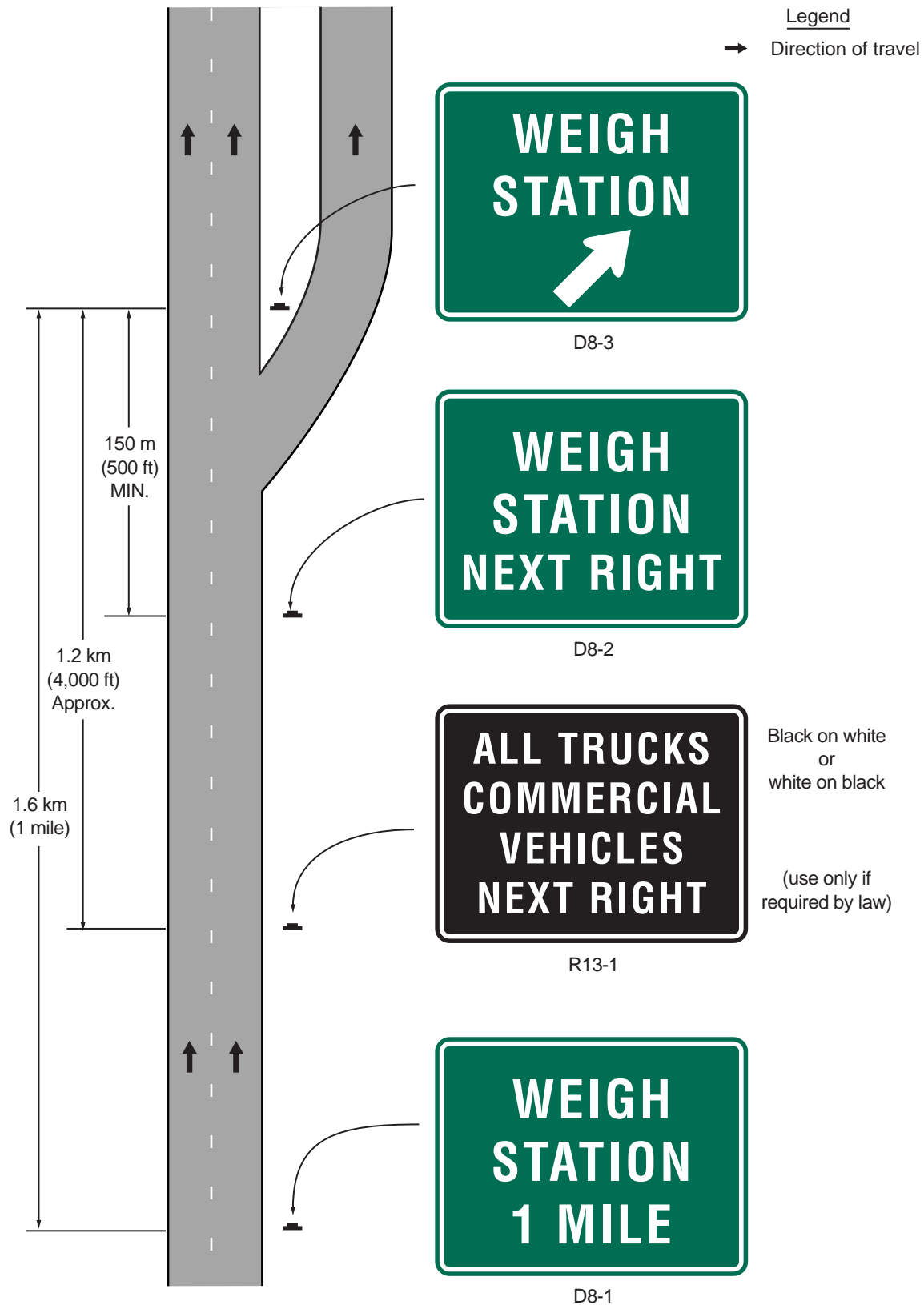

Guidance:

The Exit Direction sign (D8-2) or the Advance sign (D8-1) should display, either within the sign border or on a supplemental panel, the changeable message OPEN or CLOSED.

Section 2D.44 General Service Signs (D9 Series)**Support:**

On conventional roads, commercial services such as gas, food, and lodging generally are within sight and are available to the road user at reasonably frequent intervals along the route. Consequently, on this class of road there usually is no need for special signs calling attention to these services. Moreover, General Service signing is usually not required in urban areas except for hospitals, police assistance, tourist information centers, and camping.

Option:

General Service signs may be used where such services are infrequent and are found only on an intersecting highway or crossroad.

Standard:

All General Service signs and supplemental panels shall have white letters, symbols, and borders on a blue background.

Guidance:

General Service signs should be installed at a suitable distance in advance of the turn-off point or intersecting highway.

States that elect to provide General Service signing should establish a statewide policy or warrant for its use, and criteria for the availability of services. Local jurisdictions electing to use such signing should follow State policy for the sake of uniformity.

Option:

Individual States may sign for whatever alternative fuels are available at appropriate locations.

Standard:

General Service signs, if used at intersections, shall carry a legend for one or more of the following services: Food, Gas, Diesel, LP-Gas, Lodging, Camping,



D9-1



D9-2



D9-3



D9-4



D9-5

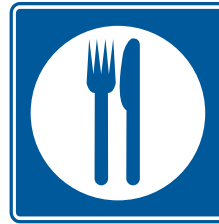

D9-6



D9-7



D9-9



D9-10



D9-11

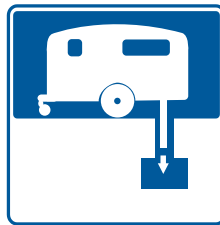

D9-12



D9-13



D9-14



D9-15

Phone, Hospital, Tourist Information, Police, or Truck Parking along with a directional message.**Option:**

The general service legends may be either symbols or word messages.

Standard:

Symbols and word message general service legends shall not be intermixed on the same sign.

Guidance:

If used, the word message TRUCK PARKING should be placed on a separate panel below the other general motorist services.

Support:

Formats for displaying different combinations of these services are presented in Section 2E.51.

Option:

If the distance to the next point at which services are available is 16 km (10 mi) or more, a sign NEXT SERVICES XX km (XX MILES) may be used as a separate panel installed below the general service sign (see Figure 2E-35).

The International Symbol of Accessibility for the Handicapped (D9-5) sign may be used beneath General Service signs where paved ramps and rest room facilities accessible to, and useable by, the physically handicapped are provided.

The Recreational Vehicle Sanitary Station (D9-12) sign may be used as needed to indicate the availability of facilities designed for the use of dumping wastes from recreational vehicle holding tanks.

The Trash Receptacle Symbol (D9-4) sign may be placed in advance of roadside turnouts or rest areas, unless it distracts the driver's attention from other more important regulatory, warning, or directional signs.

A Channel 9 Monitored (D12-3) sign may be installed as needed. Official public agencies or their designees may be shown as the monitoring agency on the sign (see Section 2E.56). An Emergency Dial XXX (D12-4) sign along with the appropriate number to dial, may be used for cellular phone communications. A Road Conditions Dial 511 sign may be installed if a 511 number is available to road users for obtaining road condition information.

The Emergency Medical Services (D9-13) symbol sign may be used to identify medical service facilities that have been included in the Emergency Medical Services system under a signing policy developed by the State and/or local highway agency.

Standard:

The Emergency Medical Services symbol sign shall not be used to identify services other than qualified hospitals, ambulance stations, and qualified free-standing emergency medical treatment centers. If used, the Emergency Medical Services symbol shall be supplemented by a sign identifying the type of service provided.

Option:

The Emergency Medical Services symbol sign may be used above the HOSPITAL or H (D9-2) symbol sign or above a panel with either the legend AMBULANCE STATION or EMERGENCY MEDICAL CARE. The Emergency Medical Services symbol sign may also be used to supplement Telephone (D9-1), CB Monitoring, or POLICE (D9-14) signs.

Standard:

The legend EMERGENCY MEDICAL CARE shall not be used for services other than qualified free-standing emergency medical treatment centers.

Guidance:

Each State should develop guidelines for the implementation of the Emergency Medical Services symbol sign.

The State should consider the following guidelines in the preparation of its policy:

A. AMBULANCE

1. 24-hour service, 7 days per week.
2. Staffed by two State-certified persons trained at least to the basic level.
3. Vehicular communications with a hospital emergency department.
4. Operator should have successfully completed an Emergency Vehicle Operator Training Course.

B. HOSPITAL

1. 24-hour service, 7 days per week.

2. Emergency department facilities with a Physician (or Emergency Care Nurse on duty within the Emergency department with a physician on-call) trained in emergency medical procedures on duty.
3. Licensed or approved for definitive medical care by an appropriate State authority.
4. Equipped for radio voice communications with ambulances and other hospitals.

C. CB 9 Monitored

1. Provided by either professional or volunteer monitors.
2. Available 24 hours per day, 7 days per week.
3. The service should be endorsed, sponsored, or controlled by an appropriate government authority to guarantee the level of monitoring.

Section 2D.45 Reference Posts (D10-1 through D10-3)

Option:

Reference posts (D10-1 to D10-3) may be installed along any section of a highway route to assist road users in estimating their progress, to provide a means for identifying the location of emergency incidents and traffic accidents, and to aid in highway maintenance and servicing.

Standard:

If reference posts are used, the distance numbering shall be continuous for each route within a state, except where overlaps occur. With overlapped routes, reference post continuity shall be established for only one of the routes.

If used, reference posts shall be vertical panels having a green background with 150 mm (6 in) white numerals, border, and the legend km (MILE) in 100 mm (4 in) white letters. The design details for reference posts shall be as shown in the "Standard Highway Signs" book.

Guidance:

Zero distance should begin at the south and west State lines, or at the south and west terminus points where routes begin within a State.



D10-1



D10-2



D10-3



I1-1

On a route without reference post continuity, the first reference post beyond the overlap should indicate the total distance traveled on the route so that road users will have a means of correlating their travel distance between reference posts with that shown on their odometer.

Option:

Reference posts may be placed up to 9 m (30 ft) from the edge of the pavement.

Standard:

Reference posts located in line with delineator posts shall have the bottom of the sign at the same height as the delineator (see Section 3D.04).

For divided highways, distance measurement shall be made on northbound and eastbound roadways. The reference posts for southbound and westbound roadways shall be set at locations directly opposite the posts for the northbound or eastbound roadways.

Option:

If a reference post cannot be installed in the correct location, it may be moved in either direction as much as 15 m (50 ft).

Guidance:

If a reference post cannot be placed within 15 m (50 ft) of the correct location, it should be omitted.

Option:

To enhance the reference post numbering system, reference posts may be spaced at one, two, or five tenths of a kilometer (mile).

Section 2D.46 Traffic Signal Speed Sign (I1-1)

Option:

The Traffic Signal Speed (I1-1) sign, reading SIGNALS SET FOR XX km/hr (XX MPH), may be used to indicate a section of street or highway on which the traffic signals are coordinated into a progressive system timed for a specified speed at all hours during which they are operated in a coordinated mode.

Guidance:

If used, the sign should be mounted as near as practical to each intersection where the timed speed changes, and at intervals of several blocks throughout any section where the timed speed remains constant.

Standard:

The Traffic Signal Speed sign shall be a minimum of 300 x 450 mm (12 x 18 in) with the longer dimension vertical. It shall have a white message and border on a green background.

Section 2D.47 General Information Signs (I Series)**Support:**

Of interest to the traveler, though not directly necessary for guidance, are numerous kinds of information that can properly be conveyed by general information signs. They include such items as State lines, city limits, other political boundaries, time zones, stream names, elevations, landmarks, and similar items of geographical interest.

Adopt-a-Highway signs provide travelers with information about organizations that take responsibility for picking up litter along a section of highway.

Guidance:

General information signs should not be installed within a series of guide signs or at other equally critical locations, unless there are specific reasons for orienting the road user or identifying control points for activities that are clearly in the public interest. On all such signs, the designs should be simple and dignified, devoid of any advertising, and in general conformance with other guide signing.

Option:

An information symbol sign (I-4 through I-11) may be used to identify a route leading to a transportation or general information facility, or to provide additional guidance to the facility. The symbol sign may be supplemented by an educational plaque where necessary; also, the name of the facility may be used if needed to distinguish between similar facilities.

Guide signs for commercial service airports and non-carrier airports may be provided from the nearest Interstate, other freeway, or conventional highway intersection directly to the airport, normally not to exceed 25 km (15 mi). The Airport (I-5) symbol sign along with a supplemental plaque may be used to indicate the specific name of the airport. An Airport symbol sign, with or without a supplemental name plaque or the word AIRPORT, and an arrow may be used as a trailblazer.



I-2



I-3



I-4



I-5



I-6

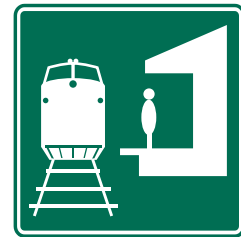

I-7

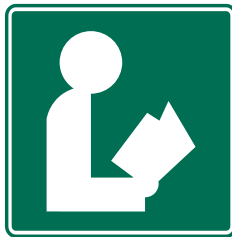

I-8



I-9



I-10



D13-1



D13-2

Standard:

Adequate trailblazer signs shall be in place prior to installing the airport guide signs.

Support:

Location and placement of all airport guide signs depends upon the availability of longitudinal spacing on highways.

Option:

Political jurisdiction logos may be placed on the political boundary general information signs. The logo may have different colors and shapes but should be simple, dignified, and devoid of any advertising.

Standard:

Except for political jurisdiction logos, scenic by-way logos, and Adopt-a-Highway signs, general information signs shall have white legends and borders on green rectangular-shaped backgrounds.

Messages, symbols, and trademarks that resemble any official traffic control device shall not be used on Adopt-a-Highway signs.

Option:

The Recycling Collection Center (I-11) symbol sign may be used to direct road users to recycling collection centers.

Guidance:

The Recycling Collection Center symbol sign should not be used on freeways and expressways.

Standard:

If used on freeways or expressways, the Recycling Collection Center symbol sign shall be considered one of the supplemental sign destinations.

Guidance:

Each agency with highway jurisdiction that elects to use Adopt-a-Highway signs should establish a signing policy that includes the following:

- A. Eligible organizations must comply with State laws prohibiting discrimination based on race, religion, color, age, sex, national origin, and laws.
- B. The use of legends conforming to the requirements of State agencies.
- C. Provision for the removal of inappropriate signs.
- D. Provision for the State to charge fees to cover the cost of installing, maintaining, and removing the signs.
- E. The use of standard highway alphabets on all word message type signs.
- F. Provision for limiting the number of signs.

Section 2D.48 Signing of Named Highways

Support:

Legislative bodies will occasionally adopt an act or resolution memorializing a highway, bridge, or other component of the highway.

Guidance:

Such memorial names should not appear on or along a highway, or be placed on bridges or other highway components. The requirement for signing should be carried out by placing memorial plaques in rest areas, at scenic overlooks, or at other appropriate locations where parking is provided with the signing inconspicuously located relative to vehicle operations along the highway.

Option:

If installation of the memorial plaque off the main roadway is not practical, memorial signs may be installed on the mainline provided that they are independent of other guide and directional signing, and they do not adversely compromise the safety or efficiency of traffic flow.

Standard:

When the memorial signs are installed on the mainline instead of off-highway memorial plaques, the signing shall be limited to one sign at an appropriate location in each route direction.

Option:

Guide signs may contain street or highway names if the purpose is to enhance driver communication and guidance; however, they are to be considered as supplemental information to route numbers.

Standard:

Highway names shall not replace official numeral designations. Memorial names shall not appear on supplemental signs or on any other information sign either on or along the highway or its intersecting routes.

The use of route signs shall be restricted to signs officially used for guidance of traffic in accordance with this Manual and the Purpose and Policy statement of the American Association of State Highway and Transportation Officials that applies to Interstate and U.S. numbered routes (see Page i for AASHTO's address).

Option:

Unnumbered routes having major importance to proper guidance of traffic may be signed if carried out in accordance with the aforementioned policies. For unnumbered highways, a name to enhance route guidance may be used where the name is applied consistently throughout its length.

Guidance:

Only one name should be used to identify any highway whether numbered or unnumbered.

Section 2D.49 Trail Signs

Support:

Trail signs are informational signs, plaques, or shields designed to provide road users with route guidance in following a trail of particular cultural, historical, or educational significance.

Guidance:

Primary guidance should be in the form of printed literature and strip maps rather than trail signing.

Option:

Trail signs may be installed on a highway if they have been approved by the appropriate transportation agency.

Section 2D.50 Crossover Signs (D13 Series)**Option:**

Crossover signs may be installed on divided highways to identify median openings not otherwise identified by warning or other guide signs.

Standard:

A CROSSOVER (D13-1) sign shall not be used to identify a median opening that is permitted to be used only by official or authorized vehicles. If used, the sign shall be a horizontal rectangle of appropriate size to carry the word CROSSOVER and a horizontal directional arrow. The CROSSOVER sign shall have a white legend and border on a green background.

Guidance:

If used, the CROSSOVER sign should be installed immediately beyond the median opening either on the right side of the roadway or in the median.

Option:

The Advance Crossover (D13-2) sign may be installed in advance of the CROSSOVER sign to provide advance notice of the crossover.

Standard:

If used, the Advance Crossover sign shall be a horizontal rectangle of appropriate size to carry the word CROSSOVER and the distance to the median opening. The sign shall have white legend and border on a green background.

Guidance:

The distance shown on the Advance Crossover sign should be either 2 km, 1 km, or 500 m (1, 1/2, or 1/4 MILE), unless unusual conditions require some other distance. If used, the sign should be installed either on the right side of the roadway or in the median at approximately the distance shown.

CHAPTER 2E. GUIDE SIGNS - FREEWAYS AND EXPRESSWAYS

Section 2E.01 Scope of Freeway and Expressway Guide Sign Standards

Support:

These standards provide a uniform and effective system of highway signing for high-volume, high-speed motor vehicle traffic on freeways and expressways. The requirements and specifications for expressway signing exceed those for conventional roads (Chapter 2D), but are less than those for freeway signing. Since there are many geometric design variables to be found in existing roads, a signing concept commensurate with prevailing conditions is the primary consideration. Section 2A.01 includes definitions of freeway and expressway.

Standard:

The standards prescribed herein for freeway or expressway guide signing shall apply to any highway that meets the definition of such facilities.

Section 2E.02 Freeway and Expressway Signing Principles

Support:

The development of a signing system for freeways and expressways is approached on the premise that the signing is primarily for the benefit and direction of road users who are not familiar with the route or area. The signing furnishes road users with clear instructions for orderly progress to their destinations. Sign installations are an integral part of the facility and, as such, are best planned concurrently with the development of highway location and geometric design. For optimal results, plans for signing are analyzed during the earliest stages of preliminary design, and details are correlated as final design is developed. The excessive signing found on many major highways usually is the result of using a multitude of signs that are too small and that are poorly designed and placed to accomplish the intended purpose.

Freeway and expressway signing is to be considered and developed as a planned system of installations. An engineering study is sometimes necessary for proper solution of the problems of many individual locations, but, in addition, consideration of an entire route is necessary.

Guidance:

Road users should be guided with consistent signing on the approaches to interchanges, as they drive from one state to another, and when driving through rural or urban areas. Because geographical, geometric, and operating factors regularly create significant differences between urban and rural conditions, the signing should take these conditions into account.

Guide signs on freeways and expressways should serve distinct functions as follows:

- A. Give directions to destinations, or to streets or highway routes, at intersections or interchanges.
- B. Furnish advance notice of the approach to intersections or interchanges.
- C. Direct road users into appropriate lanes in advance of diverging or merging movements.
- D. Identify routes and directions on those routes.
- E. Show distances to destinations.
- F. Indicate access to general motorist services, rest, scenic, and recreational areas.
- G. Provide other information of value to the road user.

Section 2E.03 General

Support:

Signs are designed so that they are legible to road users approaching them and readable in time to permit proper responses. Desired design characteristics include: (a) long visibility distances, (b) large lettering and symbols, and (c) short legends for quick comprehension.

Standard:

Standard shapes and colors shall be used so that traffic signs can be promptly recognized by road users.

Section 2E.04 Color of Guide Signs

Standard:

Guide signs on freeways and expressways, except as noted herein, shall have white letters, symbols, and borders on a green background.

Support:

Color requirements for route signs and trailblazers, signs with blank-out or changeable messages, signs for services, rest areas, park and recreational areas, and for certain miscellaneous signs are specified in the individual sections dealing with the particular sign or sign group.

Section 2E.05 Retroreflectorization or Illumination**Standard:**

Letters, numerals, symbols, and borders of all guide signs shall be retroreflectorized. The background of all signs that are not independently illuminated shall be retroreflectorized.

Support:

Where there is no serious interference from extraneous light sources, retroreflectorized ground-mounted signs usually provide adequate nighttime visibility.

On freeways and expressways where much driving at night is done with low-beam headlights, the amount of headlight illumination incident to an overhead sign display is relatively small.

Guidance:

Overhead sign installations should be illuminated unless an engineering study shows that retroreflectorization alone will perform effectively. The type of illumination chosen should provide effective and reasonably uniform illumination of the sign face and message.

Section 2E.06 Characteristics of Urban Signing**Support:**

Urban conditions are characterized not so much by city limits or other arbitrary boundaries, but by the following features:

- A. Mainline roadways with more than two lanes in each direction.
- B. High traffic volumes on the through roadways.
- C. High volumes of traffic entering and leaving interchanges.
- D. Interchanges closely spaced.
- E. Roadway and interchange lighting.
- F. Three or more interchanges serving the major city.
- G. A loop, circumferential, or spur serving a sizable portion of the urban population.
- H. Visual clutter from roadside development.

Operating conditions and road geometrics on urban freeways and expressways usually make special sign treatments desirable, including:

- A. Use of Interchange Sequence signs (see Section 2E.37).
- B. Use of sign spreading to the maximum extent possible (see Section 2E.11).
- C. Elimination of service signing (see Section 2E.51).
- D. Reduction to a minimum of post-interchange signs (see Section 2E.35).
- E. Display of advance signs at distances closer to the interchange, with appropriate adjustments in the legend (see Section 2E.30).
- F. Use of overhead signs on roadway structures and independent sign supports (see Section 2E.22).
- G. Use of diagrammatic signs in advance of intersections and interchanges (see Section 2E.19).
- H. Frequent use of street names as the principal message in guide signs.

Lower speeds which are often characteristic of urban operations do not justify lower signing standards. Typical traffic patterns are more complex for the road user to negotiate, and large, easy-to-read legends are, therefore, just as necessary as on rural highways.

Section 2E.07 Characteristics of Rural Signing

Support:

Rural areas ordinarily have greater distances between interchanges, which permits adequate spacing for the sequences of signs on the approach to and departure from each interchange. However, the absence of traffic in adjoining lanes and on entering or exiting ramps often adds monotony or inattention to rural driving. This increases the importance of signs that call for decisions or actions.

Guidance:

Where there are long distances between interchanges and the alignment is relatively unchanging, signs should be positioned for their best effect on road users. The tendency to group all signing in the immediate vicinity of rural interchanges should be avoided by considering the entire route in the development of sign plans. Extra effort should be given to the placement of signs at natural target locations to command the attention of the road user, particularly when the message requires an action by the road user.

Section 2E.08 Memorial Highway Signing**Guidance:**

Freeways and expressways should not be signed as memorial highways. If a route, bridge, or highway component is officially designated as a memorial, and if notification of the memorial is to be made on the highway right-of-way, such notification should consist of installing a memorial plaque in a rest area, scenic overlook, recreational area, or other appropriate location where parking is provided with the signing inconspicuously located relative to vehicle operations along the highway.

Option:

If the installation of a memorial plaque off the main roadway is not practical, a memorial sign may be installed on the mainline.

Standard:

Where such memorial signs are installed on the mainline, (1) memorial names shall not appear on directional guide signs, (2) memorial signs shall not interfere with the placement of any other necessary highway signing, and (3) memorial signs shall not compromise the safety or efficiency of traffic flow. The memorial signing shall be limited to one sign at an appropriate location in each route direction.

Section 2E.09 Amount of Legend on Guide Signs**Guidance:**

No more than two destination names or street names should be shown on any Advance Guide sign or Exit Direction sign. A city name and street name on the same sign should be avoided. Where two or three signs are placed on the same supports, destinations or names should be limited to one per sign, or to a total of three in the display. Sign legends should not exceed three lines of copy.

Option:

Sign legends may include symbols, route numbers, arrows, cardinal directions, and exit instructions.

Section 2E.10 Number of Signs at an Overhead Installation**Guidance:**

If overhead signs are warranted, as set forth in Section 2A.17, the number of signs at these locations should be limited to only those essential in communicating pertinent destination information to the road user. Exit Direction signs for a single exit and the Advance Guide signs should have only one panel with one or two destinations. Regulatory signs, such as speed limits, should not be used in conjunction with overhead guide sign installations. Because road users have limited time to read and comprehend sign messages, there should not be more than three guide signs displayed at any one location either on the overhead structure or its support.

Option:

At overhead locations, more than one sign may be installed to advise of a multiple exit condition at an interchange. If the roadway ramp or crossing roadway has complex or unusual geometrics, additional signs with confirming messages may be provided to properly guide the road user.

Section 2E.11 Sign Spreading and Pull-Through Signs**Support:**

Sign spreading is a concept where major overhead signs are spaced so that road users are not overloaded with a group of signs at a single location. Figure 2E-1 illustrates an example of sign spreading. Pull-Through signs (see Figure 2E-2) are overhead lane use signs intended for through traffic.

Guidance:

Where overhead signing is used, sign spreading should be used at all single exit interchanges and to the extent possible at multi-exit interchanges. Sign spreading should be accomplished by use of the following:

- A. The Exit Direction sign should be the only sign used in the vicinity of the gore (other than the Gore sign). It should be located overhead near the theoretical gore and generally on an overhead sign support structure.
- B. The Advance Guide sign to indicate the next interchange exit should be placed near the crossroad location. If the crossroad goes over the mainline, the Advance Guide sign should be placed on the overcrossing structure.
- C. Pull-Through signs should be used only when the geometrics of a given interchange are such that it is not clear to the road user as to which is the through

Figure 2E-1. Example of Guide Sign Spreading

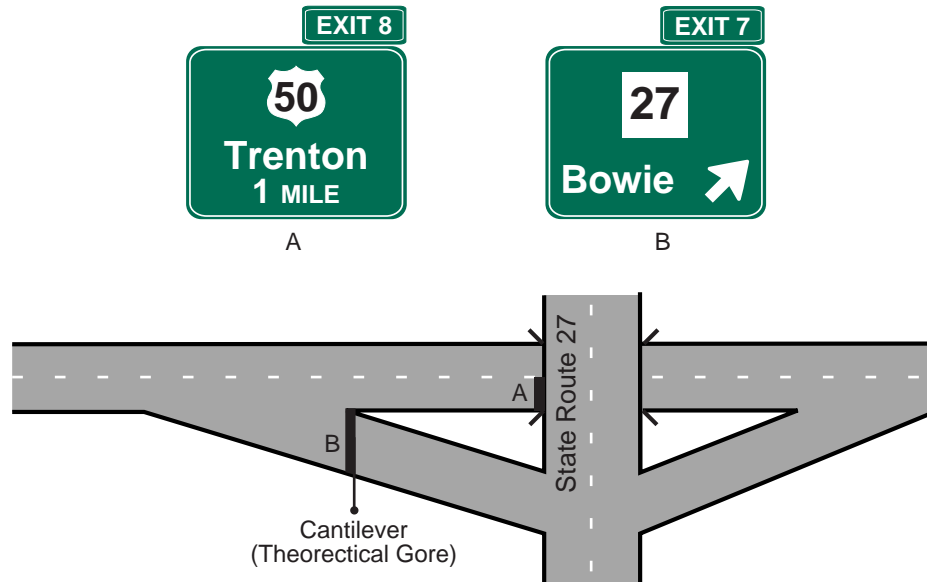
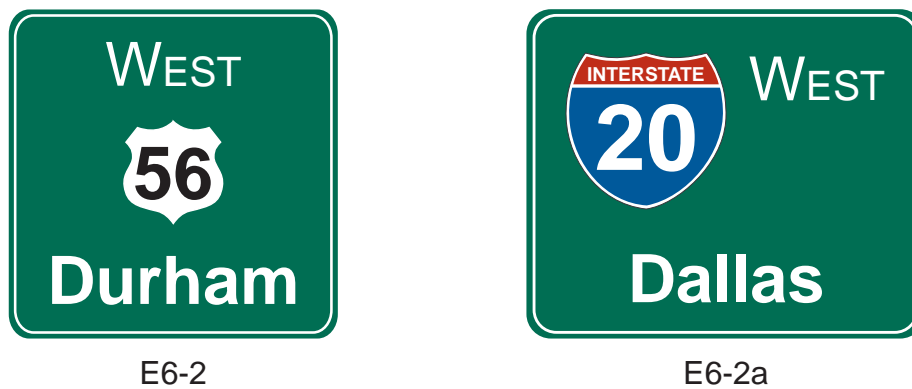

Figure 2E-2. Pull-Through Signs



roadway, or where additional route guidance is desired. Pull-Through signs with down arrows should be used when the alignment and number of through lanes is not readily evident.

Section 2E.12 Designation of Destinations

Standard:

The direction of a freeway and the major destinations or control cities (see Section 2D.34) along it shall be clearly identified through the use of appropriate destination legends. Successive freeway guide signs shall provide continuity in destination names and consistency with available map information. At any decision point, a given destination shall be indicated by way of only one route.

Guidance:

Control city legends should be used in the following situations along a freeway:

- A. Interchanges between freeways.
- B. Separation points of overlapping freeway routes.
- C. On directional signs on intersecting routes, to guide traffic entering the freeway.
- D. On Pull-Through signs.
- E. On the bottom line of post-interchange distance signs.

Support:

Continuity of destination names is also useful on expressways serving long-distance or intrastate travel.

The determination of major destinations or control cities is important to the quality of service provided by the freeway. Control cities on freeway guide signs are selected by the States and are contained in the "List of Control Cities for Use in Guide Signs on Interstate Highways," published and available from American Association of State and Highway Transportation Officials (see Page i for AASHTO's address).

Section 2E.13 Size and Style of Letters and Signs**Standard:**

With all freeway and expressway signs, the message dimensions shall be determined first, and the outside sign dimensions secondarily. Word messages in the legend of expressway guide signs shall be in letters at least 200 mm (8 in) high. Larger lettering shall be used for major guide signs at or in advance of interchanges and for all overhead signs. Minimum numeral and letter sizes for expressway guide signs according to interchange classification, type of sign and component of sign legend are shown in Tables 2E-1 and 2E-2. Minimum numeral and letter sizes for freeway guide signs, according to interchange classification, type of sign, and component of sign legend, appear in Tables 2E-3 and 2E-4. All names of places, streets, and highways on freeway and expressway guide signs shall be composed of lower-case letters with initial upper-case letters. Other word legends shall be in capital letters. The initial letters and the numerals used shall be Series E(M) of the "Standard Alphabets for Highway Signs" book. Interline and edge spacing shall be as specified in Section 2E.14.

Lettering size on freeway and expressway signs shall be the same for both rural and urban conditions.

Support:

Sign size is determined primarily in terms of the length of the message and the size of the lettering necessary for proper legibility. Letter style and height, and arrow design have been standardized for freeway and expressway signs to assure uniform and effective application.

Designs for upper-case, lower-case, and capital alphabets together with tables of recommended letter spacing, are shown in the "Standard Alphabets for Highway Signs" book.

Guidance:

Where upper- and lower-case lettering is used, the initial upper-case letters should be approximately 1.33 times the "loop" height of the lower-case letters. Freeway lettering sizes (see Tables 2E-3 and 2E-4) should be used when expressway geometric design is comparable to freeway standards.

Other sign letter size requirements not specifically identified elsewhere in this Manual should be guided by these specifications. Abbreviations should be kept to a minimum.

Support:

A sign mounted over a particular roadway lane to which it applies might have to be limited in horizontal dimension to the width of the lane, so that another sign can be placed over an

Table 2E-1. Minimum Letter and Numeral Sizes for Expressway Guide Signs According to Interchange Classification
(sizes shown in millimeters)

Type of Sign	Type of Interchange (see Section 2E.29)				Overhead
	Major		Intermediate	Minor	
	Category a	Category b			
A. Advance Guide, Exit Direction, and Overhead Guide Signs					
Exit Plaque					
Word	250	250	250	200	250
Numeral & Letter	375	375	375	300	375
Interstate Route Sign					
Numeral	450	—	—	—	450
1 or 2 Digit Shield	900 x 900	—	—	—	900 x 900
3 Digit Shield	1125 x 900	—	—	—	1125 x 900
U.S. or State Route Sign					
Numeral	450	450	450	300	450
1 or 2 Digit Shield	900 x 900	900 x 900	900 x 900	600 x 600	900 x 900
3 Digit Shield	1125 x 900	1125 x 900	1125 x 900	750 x 600	1125 x 900
Alternate (Example: U.S. Alt. 56)					
Letters	375	300	300	250	300
Numeral	450	375	375	300	375
Cardinal Direction					
First Letter	450	375	300	250	375
Rest of Word	375	300	250	200	300
Name of Destination					
Upper-Case Letters	500	400	330	265	400
Lower-Case Letters	375	300	250	200	300
Distance Number	450	375	300	250	375
Distance Fraction	300	250	250	200	250
Distance Word	300	250	250	200	250
Action Message Word	250	250	250	200	250
B. Gore Signs					
Word	250	250	250	200	—
Numeral & Letter	300	300	300	250	—

Table 2E-1. Minimum Letter and Numeral Sizes for Expressway Guide Signs According to Interchange Classification
(sizes shown in inches)

Type of Sign	Type of Interchange (see Section 2E.29)				Overhead
	Major		Intermediate	Minor	
	Category a	Category b			
A. Advance Guide, Exit Direction, and Overhead Guide Signs					
Exit Plaque					
Word	10	10	10	8	10
Numeral & Letter	15	15	15	12	15
Interstate Route Sign					
Numeral	18	—	—	—	18
1 or 2 Digit Shield	36 x 36	—	—	—	36 x 36
3 Digit Shield	45 x 36	—	—	—	45 x 36
U.S. or State Route Sign					
Numeral	18	18	18	12	18
1 or 2 Digit Shield	36 x 36	36 x 36	36 x 36	24 x 24	36 x 36
3 Digit Shield	45 x 36	45 x 36	45 x 36	30 x 24	45 x 36
Alternate (Example: U.S. Alt. 56)					
Letters	15	12	12	10	12
Numeral	18	15	15	12	15
Cardinal Direction					
First Letter	18	15	12	10	15
Rest of Word	15	12	10	8	12
Name of Destination					
Upper-Cases Letters	20	16	13.3	10.6	16
Lower-Case Letters	15	12	10	8	12
Distance Number	18	15	12	10	15
Distance Fraction	12	10	10	8	10
Distance Word	12	10	10	8	10
Action Message Word	10	10	10	8	10
B. Gore Signs					
Word	10	10	10	8	—
Numeral & Letter	12	12	12	10	—

**Table 2E-2. Minimum Letter and Numeral Sizes for Expressway
Guide Signs According to Sign Type (Sheet 1 of 2)**

Type of Sign	Minimum Size (mm)	Minimum Size (inches)
A. Pull-Through Signs		
Destination — Upper-Case Letters	330	13.3
Destination — Lower-Case Letters	250	10
Route Sign as Message		
Cardinal Direction	250	10
1- or 2-Digit Shield	900 x 900	36 x 36
3-Digit Shield	1125 x 900	45 x 36
B. Supplemental Guide Signs		
Exit Number Word	200	8
Exit Number Numeral and Letter	300	12
Place Name — Upper-Case Letters	265	10.6
Place Name — Lower-Case Letters	200	8
Action Message	200	8
C. Changeable Message Signs		
Characters	265*	10.6*
D. Interchange Sequence Signs		
Word — Upper-Case Letters	265	10.6
Word — Lower-Case Letters	200	8
Numeral	250	10
Fraction	200	8
E. Next X Exits Sign		
Place Name — Upper-Case Letters	265	10.6
Place Name — Lower-Case Letters	200	8
NEXT X EXITS	200	8
F. Distance Signs		
Word — Upper-Case Letters	200	8
Word — Lower-Case Letters	150	6
Numeral	200	8
G. General Services Signs		
Exit Number Word	200	8
Exit Number Numeral and Letter	300	12
Services	200	8
H. Rest Area and Scenic Area Signs		
Word	250	10
Distance Numeral	300	12
Distance Fraction	200	8
Distance Word	250	10
Action Message Word	250	10

**Table 2E-2. Minimum Letter and Numeral Sizes for Expressway
Guide Signs According to Sign Type (Sheet 2 of 2)**

Type of Sign	Minimum Size (mm)	Minimum Size (inches)
I. Reference Posts		
Word	100	4
Numeral	250	10
J. Boundary and Orientation Signs		
Word — Upper-Case Letters	200	8
Word — Lower-Case Letters	150	6
K. Next Exit and Next Services Signs		
Word and Numeral	200	8
L. Exit Only Signs		
Word	300	12

*Changeable Message Signs may often require larger sizes than the minimum. A size of 450 mm (18 in) should be used where traffic speeds are greater than 90 km/h (55 mph), in areas of persistent inclement weather, or where complex driving tasks are involved.

Table 2E-3. Minimum Letter and Numeral Sizes for Freeway Guide Signs According to Interchange Classification
(sizes shown in millimeters)

Type of Sign	Type of Interchange (see Section 2E.29)				Overhead
	Major		Intermediate	Minor	
	Category a	Category b			
A. Advance Guide, Exit Direction, and Overhead Guide Signs					
Exit Plaque					
Word	250	250	250	250	250
Numeral & Letter	375	375	375	375	375
Interstate Route Sign					
Numeral	600/450	—	—	—	450
1- or 2-Digit Shield	1200 x 1200/ 300 x 300	—	—	—	900 x 900
3-Digit Shield	1500 x 1200/ 1125 x 900	—	—	—	1125 x 900
U.S. or State Route Sign					
Numeral	600/450	450	450	300	450
1- or 2-Digit Shield	1200 x 1200/ 300 x 300	900 x 900	900 x 900	600 x 600	900 x 900
3-Digit Shield	1500 x 1200/ 1125 x 900	1125 x 900	1125 x 900	750 x 600	1125 x 900
Alternate (Example: U.S. Alt. 56)					
Letters	375	375/300	300	250	300
Numeral	450	450/375	375	300	375
Cardinal Direction					
First Letter	450	375	375	250	300
Rest of Word	375	300	300	200	300
Name of Destination					
Upper-Case Letters	500	500	400	330	400
Lower-Case Letters	375	375	300	250	300
Distance Number	450	450/375	375	300	375
Distance Fraction	300	300/250	250	200	250
Distance Word	300	300/250	250	200	250
Action Message Word					
B. Gore Signs					
Word	300	300	300	200	—

Note: (/) Slanted bar signifies separation of desirable and minimum sizes.

Table 2E-3. Minimum Letter and Numeral Sizes for Freeway Guide Signs According to Interchange Classification
(sizes shown in inches)

Type of Sign	Type of Interchange (see Section 2E.29)				Overhead
	Major		Intermediate	Minor	
	Category a	Category b			
A. Advance Guide, Exit Direction, and Overhead Guide Signs					
Exit Plaque					
Word	10	10	10	10	10
Numeral & Letter	15	15	15	15	15
Interstate Route Sign					
Numeral	24/18	—	—	—	18
1- or 2-Digit Shield	48 x 48/ 36 x 36	—	—	—	36 x 36
3-Digit Shield	60 x 48/ 45 x 36	—	—	—	45 x 36
U.S. or State Route Sign					
Numeral	24/18	18	18	12	18
1- or 2-Digit Shield	48 x 48/ 36 x 36	36 x 36	36 x 36	24 x 24	36 x 36
3-Digit Shield	60 x 48/ 45 x 36	45 x 36	45 x 36	30 x 24	45 x 36
Alternate (Example: U.S. Alt. 56)					
Letters	15	15/12	12	10	12
Numeral	18	18/15	15	12	15
Cardinal Direction					
First Letter	18	15	15	10	15
Rest of Word	15	12	12	8	12
Name of Destination					
Upper-Case Letters	20	20	16	13.3	16
Lower-Case Letters	15	15	12	10	12
Distance Number	18	18/15	15	12	15
Distance Fraction	12	12/10	10	8	10
Distance Word	12	12/10	10	8	10
Action Message Word					
B. Gore Signs					
Word	12	12	12	8	—
Numeral & Letter	15	15	15	10	—

Note: (/) Slanted bar signifies separation of desirable and minimum sizes.

Table 2E-4. Minimum Letter and Numeral Sizes for Freeway Guide Signs According to Sign Type (Sheet 1 of 2)

Type of Sign	Minimum Size (mm)	Minimum Size (inches)
A. Pull-Through Signs		
Destination — Upper-Case Letters	400	16
Destination — Lower-Case Letters	300	12
Route Sign as Message		
Cardinal Direction	300	12
1- or 2-Digit Shield	900 x 900	36 x 36
3-Digit Shield	1125 x 900	45 x 36
B. Supplemental Guide Signs		
Exit Number Word	250	10
Exit Number Numeral and Letter	375	15
Place Name — Upper-Case Letters	330	13.3
Place Name — Lower-Case Letters	250	10
Action Message	250	10
C. Changeable Message Signs		
Characters	265*	10.6*
D. Interchange Sequence Signs		
Word — Upper-Case Letters	330	13.3
Word — Lower-Case Letters	250	10
Numeral	330	13.3
Fraction	250	10
E. Next X Exits Sign		
Place Name — Upper-Case Letters	330	13.3
Place Name — Lower-Case Letters	250	10
NEXT X EXITS	250	10
F. Distance Signs		
Word — Upper-Case Letters	200	8
Word — Lower-Case Letters	150	6
Numeral	200	8
G. General Service Signs		
Exit Number Word	250	10
Exit Number Numeral and Letter	375	15
Services	250	10
H. Rest Area and Scenic Area Signs		
Word	300	12
Distance Numeral	375	15
Distance Fraction	300	12
Distance Word	250	10
Action Message Word	300	12

Table 2E-4. Minimum Letter and Numeral Sizes for Freeway Guide Signs According to Sign Type (Sheet 2 of 2)

Type of Sign	Minimum Size (mm)	Minimum Size (inches)
I. Reference Posts		
Word	100	4
Numeral	250	10
J. Boundary and Orientation Signs		
Word — Upper-Case Letters	200	8
Word — Lower-Case Letters	150	6
K. Next Exit and Next Services Signs		
Word and Numeral	200	8
L. Exit Only Signs		
Word	300	12
M. Diagrammatic Signs		
Lane Widths	125	5
Lane Line Segments	25 x 150	1 x 6
Gap Between Lane Lines	150	6
Stem Height (up to upper point of departure)	750	30
Arrowhead (standard "up" arrow)	200	8
Space Between Arrowhead and Route Shield	300	12

*Changeable Message Signs may often require larger sizes than the minimum. A size of 450 mm (18 in) should be used where traffic speeds are greater than 90 km/h (55 mph), in areas of persistent inclement weather, or where complex driving tasks are involved.

adjacent lane. The necessity to maintain proper vertical clearance might also place a further limitation on the size of the overhead sign and the legend that can be accommodated.

Section 2E.14 Interline and Edge Spacing

Guidance:

Interline spacing of upper-case letters should be approximately three-fourths the average of upper-case letter heights in adjacent lines of letters.

The spacings to the top and bottom borders should be equal to the average of the letter height of the adjacent line of letters. The lateral spacing to the vertical borders should be essentially the same as the height of the largest letter.

Section 2E.15 Sign Borders

Standard:

Signs shall have a border of the same color as the legend in order to outline their distinctive shape and thereby give them easy recognition and a finished appearance.

Guidance:

For guide signs larger than 3,000 x 1,000 mm (120 x 72 in), the border should have a width of 50 mm (2 in). For smaller guide signs, a border width of 30 mm (1.25 in) should be used, but the width should not exceed the stroke width of the major lettering on the sign.

Corner radii of sign borders should be one-eighth of the minimum sign dimension on guide signs, except that the radii should not exceed 300 mm (12 in) on any sign.

Option:

The sign material in the area outside of the corner radius may be trimmed.

Section 2E.16 Abbreviations

Guidance:

Abbreviations should be kept to a minimum; however, they are useful when complete destination messages produce excessively long signs. If used, abbreviations should be unmistakably recognized by road users (see Section 1A.14).

Periods should not be used, except when a cardinal direction is abbreviated as part of a destination name.

Standard:

The words NORTH, SOUTH, EAST, and WEST shall not be abbreviated when used with route signs to indicate cardinal directions on guide signs.

Section 2E.17 Symbols

Standard:

Symbol designs shall be essentially like those shown in this Manual and the "Standard Highway Signs" book.

Guidance:

A special effort should be made to balance legend components for maximum legibility of the symbol with the rest of the sign.

Option:

Educational plaques may be used below symbol signs where needed.

Section 2E.18 Arrows for Interchange Guide Signs

Standard:

On all Exit Direction signs, both overhead and ground mounted, arrows shall be upward slanting and shall be located on the side of the sign consistent with the direction of the exiting movement.

Downward pointing arrows shall be used only for overhead guide signs to prescribe lane assignment for traffic bound for a destination or route that can be reached only by being in the designated lane(s).

Option:

Downward pointing arrows may be tilted where it is desired to emphasize the separation of roadways.

Support:

Examples of arrows for use on guide signs are shown in Figure 2D-1. Detailed dimensions of arrows are provided in the "Standard Highway Signs" book.

Section 2E.19 Diagrammatic Signs

Support:

Diagrammatic signs are guide signs that show a graphic view of the exit arrangement in relationship to the main highway. Use of such guide signs has been shown to be superior to conventional guide signs for some interchanges.

Standard:

Diagrammatic signs shall be designed in accordance with the following criteria:

- A. The graphic legend shall be of a plan view showing a simplified off-ramp arrangement.**
- B. No other symbols or route shields shall be used as a substitute for arrowheads.**
- C. They shall not be installed at the exit direction location (see Section 2E.33).**
- D. The EXIT ONLY panel shall not be used on diagrammatic signs at any major split.**

Guidance:

Diagrammatic signs should be designed in accordance with the following additional criteria:

- A. The graphic should not depict deceleration lanes.
- B. No more than one destination should be shown for each arrowhead, and no more than two destinations should be shown per sign.
- C. A black on yellow EXIT ONLY panel should be used to supplement a lane drop graphic.
- D. The shaft for the exit ramp movement should be shorter than, but not separated from, the through movement graphic.
- E. Arrow shafts should contain lane lines where appropriate.
- F. Route shields, cardinal directions, and destinations should be clearly related to the arrowhead, and the arrowhead should point toward the route shield for the off movement.
- G. The cardinal direction should be placed adjacent to the route shield, and the destination should be placed below and justified with the route shield.

Diagrammatic signs should be used at the Advance Guide sign location(s) for the following:

- A. Left exits (see Figure 2E-3).

Figure 2E-3. Diagrammatic Sign for a Single-Lane Left Exit



- B. Splits where the off-route movement is to the left (see Figure 2E-4).
- C. Optional lane splits for non-overlapping routes (see Figure 2E-5).
- D. Where a two-lane exit has an optional lane that carries the through route (see Figures 2E-6 and 2E-7). These interchanges create serious expectancy problems for drivers who are unfamiliar with the interchange.
- E. Left exit interchange lane drop situations. In this situation, an EXIT ONLY (E11-1c) panel should be used without a down arrow for advance guide signs (see Figure 2E-8).

Standard:

Diagrammatic signs have been shown to be inferior to conventional signs at cloverleaf interchanges and shall not be used at these locations.

Support:

Specific guidelines for more detailed design of diagrammatic signs are contained in the "Standard Highway Signs" book.

Section 2E.20 Signing for Interchange Lane Drops

Standard:

Major guide signs for all lane drops at interchanges shall be mounted overhead. An EXIT ONLY panel shall be used for all interchange lane drops at which the through route is carried on the mainline.

Guidance:

The EXIT ONLY (E11-1) panel should be used on all signing of lane drops on all Advance Guide signs for right exits (see Figure 2E-9). For lane drops on the left side, diagrammatic signing with the EXIT ONLY (E11-1c) panel should be used without a down arrow for Advance Guide signs (see Figure 2E-8).

Standard:

The Exit Direction (E11-1a) sign for all lane drops shall be of the format shown in Figure 2E-8. The standard slanted up arrow (left or right side) shall be used with the EXIT ONLY (E11-1) panel at the Exit Direction sign location.

Figure 2E-4. Diagrammatic Signs for Split with Dedicated Lanes

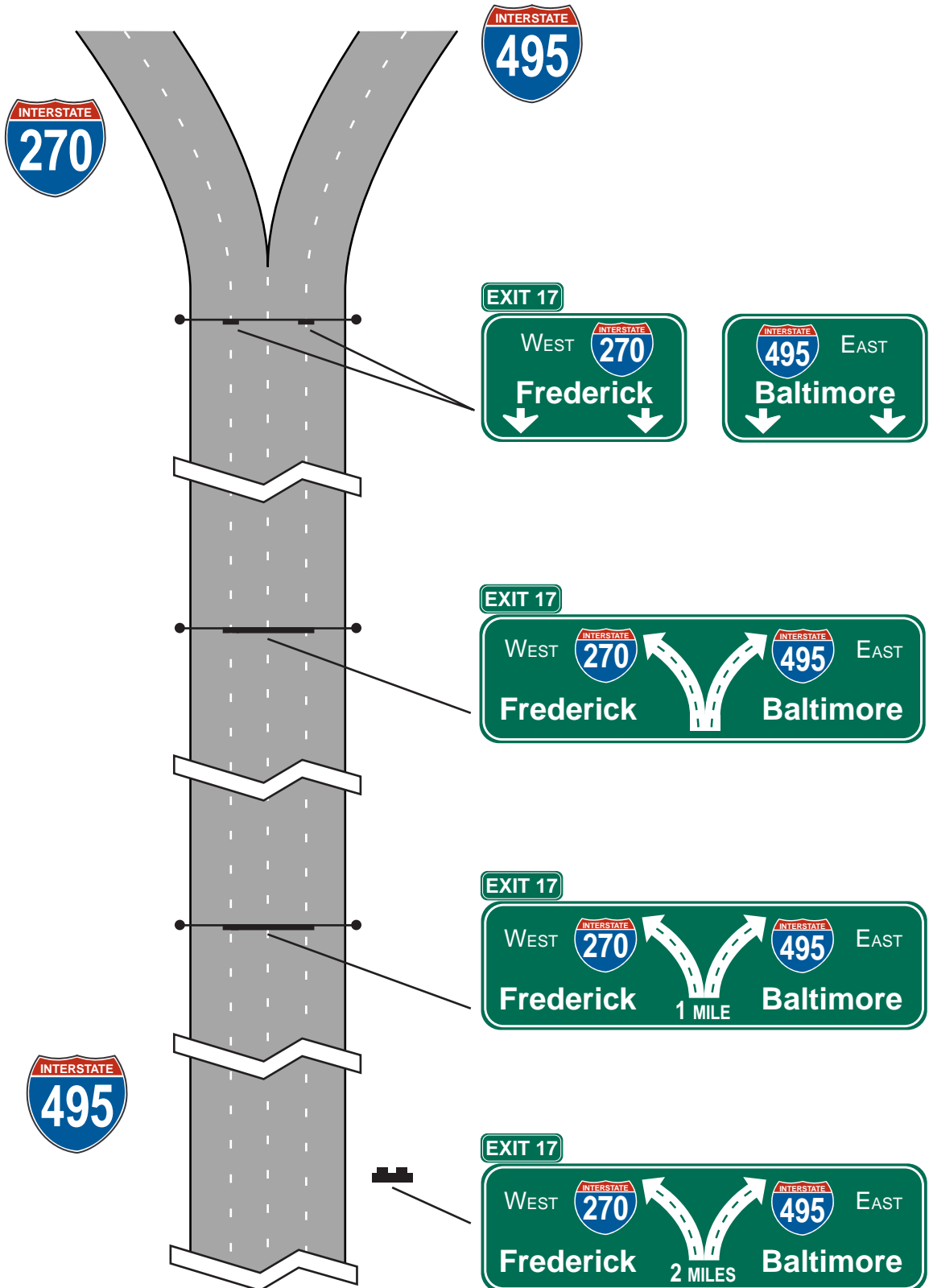

Figure 2E-5. Diagrammatic Signs for Split with Optional Lane

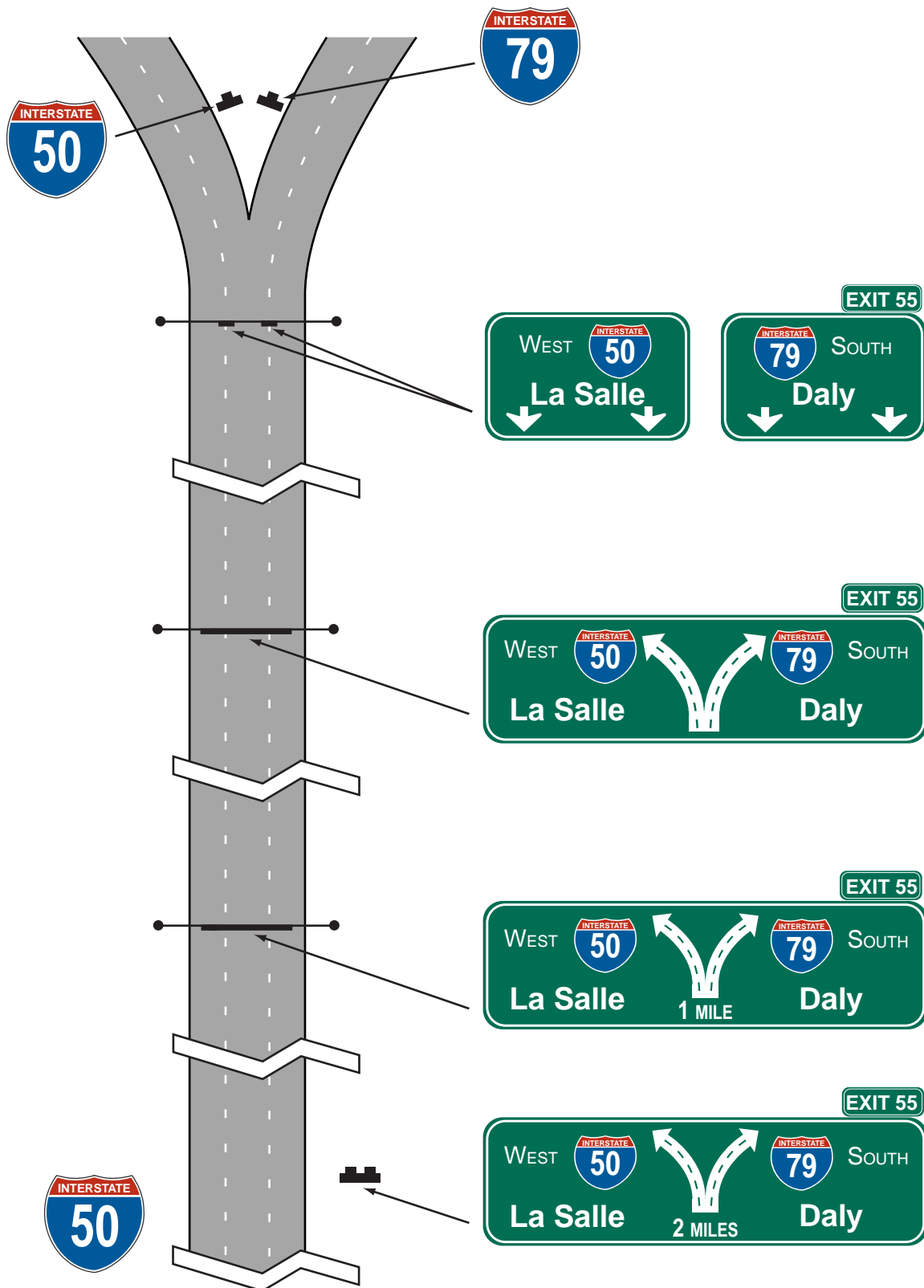

Figure 2E-6. Diagrammatic Signs for Two-Lane Exit with Optional Lane and Route Discontinuity

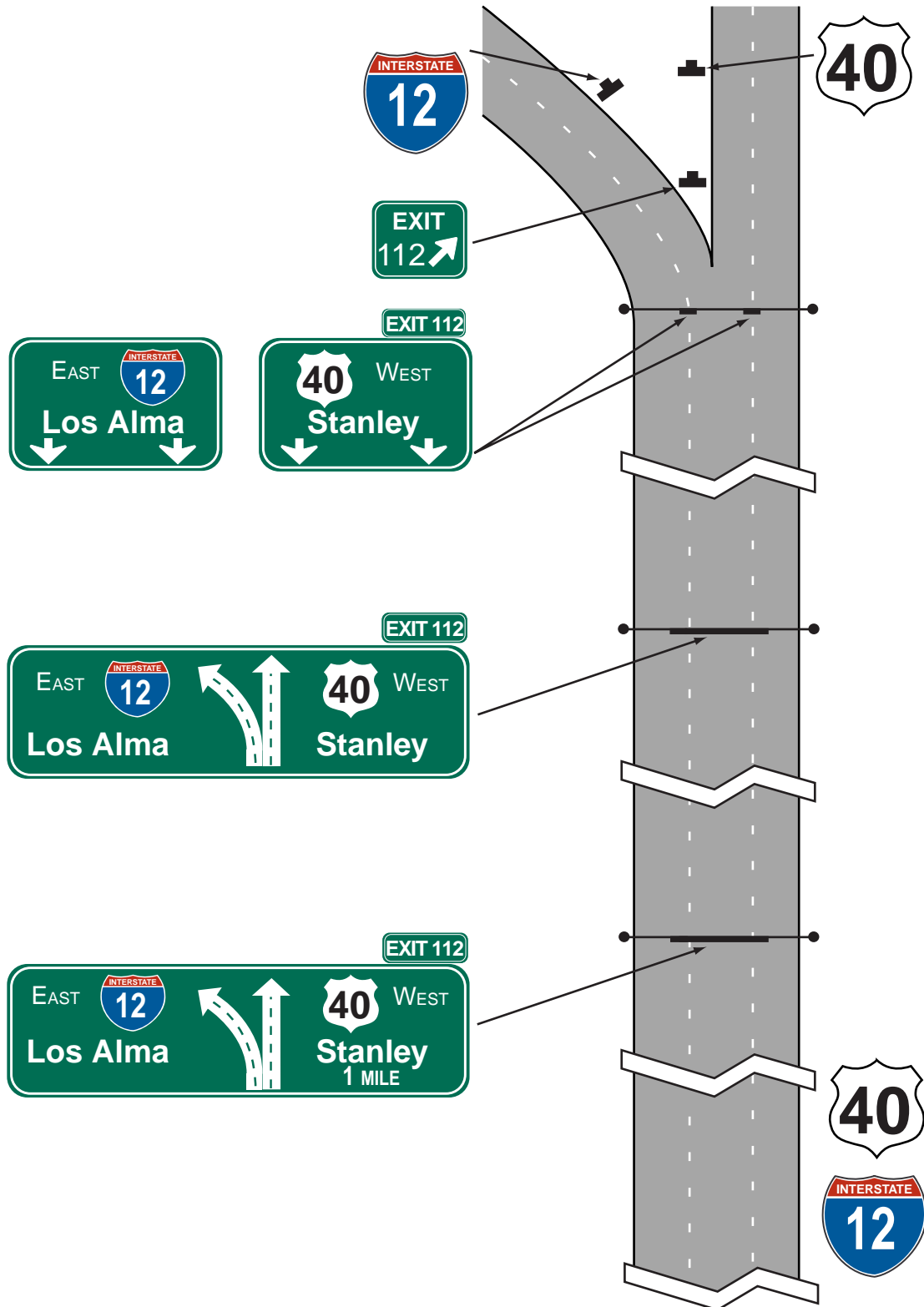

Figure 2E-7. Diagrammatic Signs for Two-Lane Exit with Optional Lane

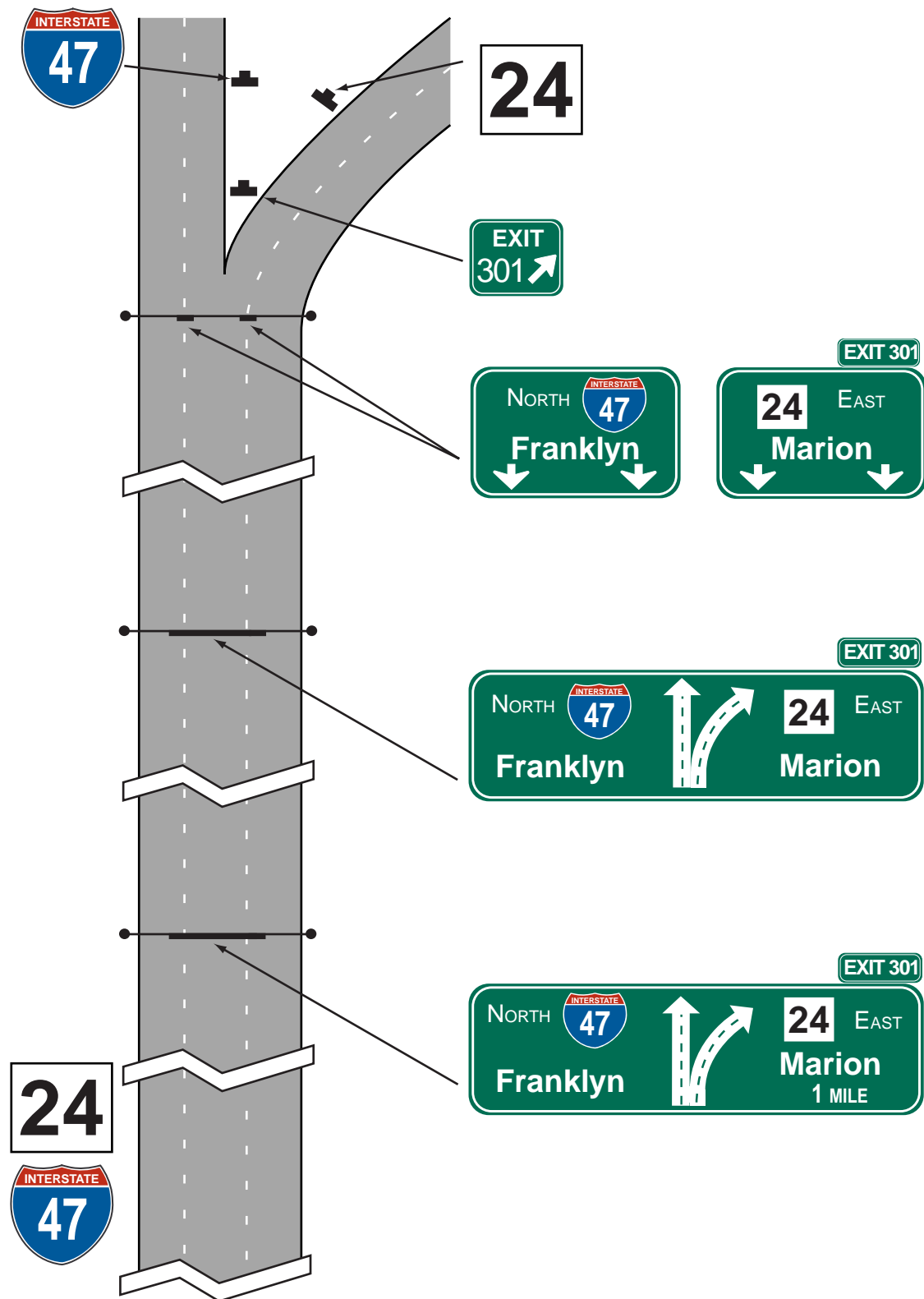
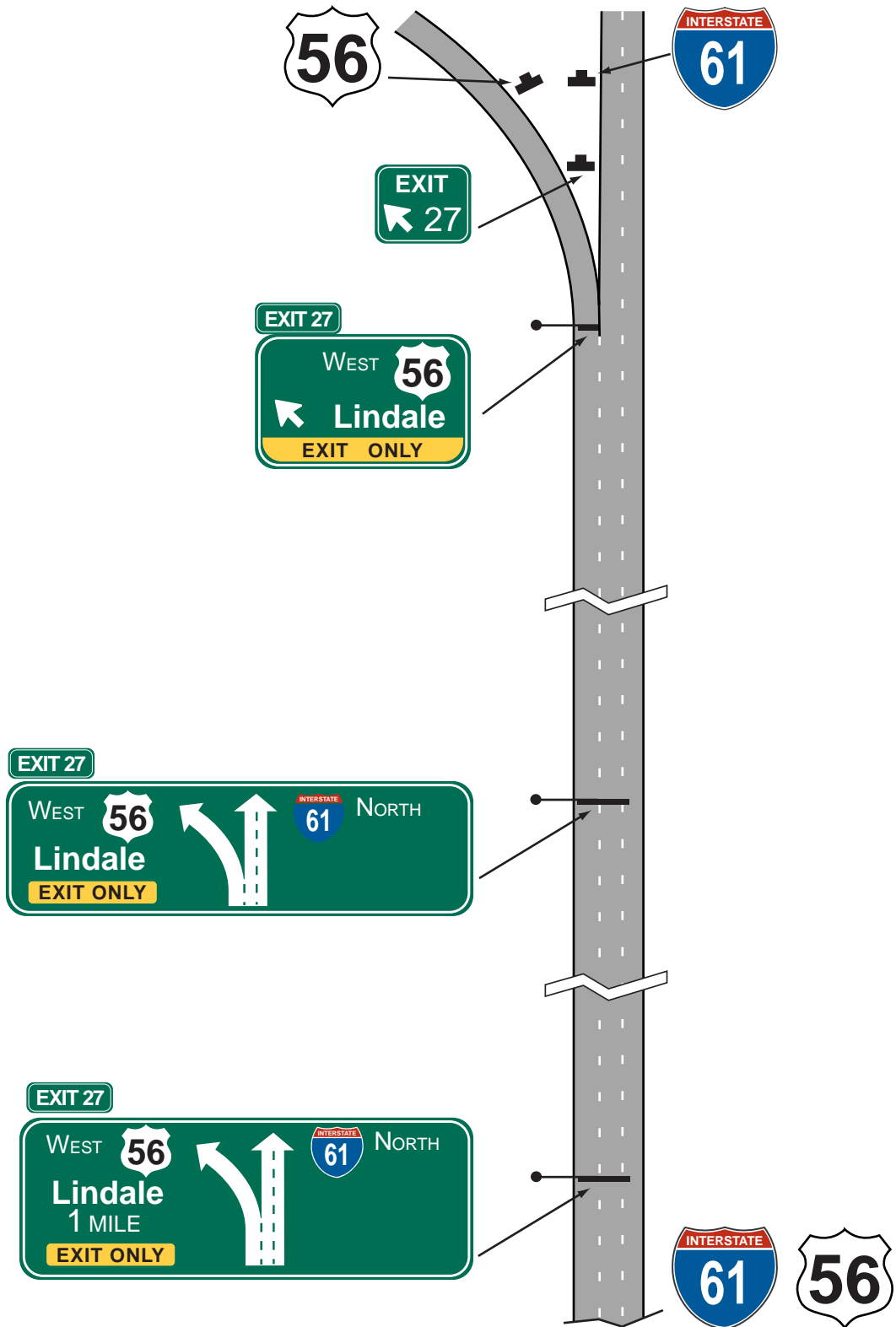

Figure 2E-8. EXIT ONLY on Left with Diagrammatic Sign for Left Lane Dropped at Interchange





E11-1



E11-1a



E11-1b



E11-1c

Figure 2E-9. EXIT ONLY Panels for Right Lane Dropped at an Interchange

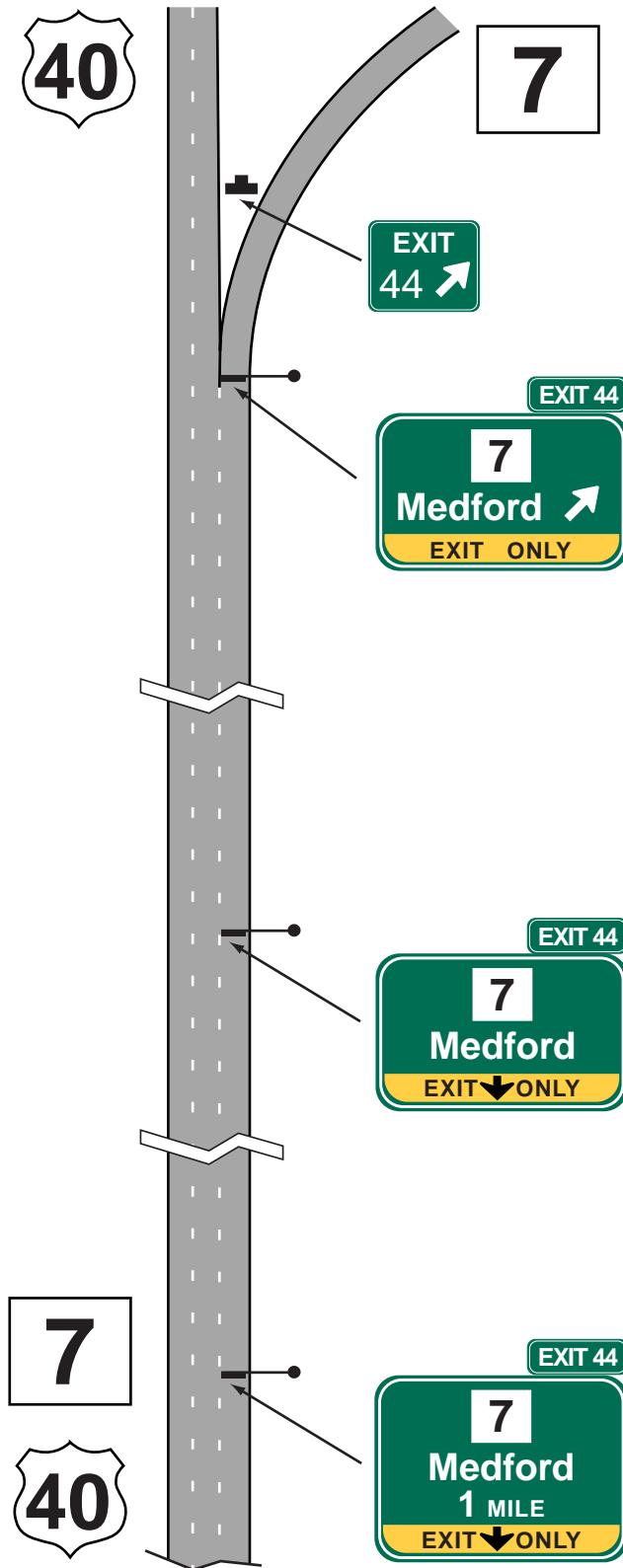

Option:

EXIT ONLY messages of either E11-1b or E11-1c formats may be used to retrofit existing signing to warn of a lane drop situation ahead.

Standard:

If used on an existing sign, the E11-1b panel shall be placed on either side of a white down arrow. The E11-1c panel, if used on an existing nondiagrammatic sign, shall be placed between the lower destination message and the white down arrow.

Guidance:

Advance Guide signs for lane drops within 2 km (1 mi) of the interchange should not contain the distance message.

Wherever the dropped lane carries the through route, diagrammatic signs should be used without the EXIT ONLY panel.

Section 2E.21 Changeable Message Signs**Standard:**

Changeable message signs shall be capable of displaying several messages in a sequence. Such messages shall be changed manually, by remote control, or by automatic controls. Changeable message signs shall display pertinent traffic operational and guidance information only, not advertising.

Support:

Because technology for changeable message signs continues to advance, a specific standard for changeable message signs is not practical. Considerations that influence the selection of the best sign for a particular application include conspicuity, legibility, operation, and maintenance of the changeable message sign. This Section applies to signs for use on freeway and expressway mainlines. It is recognized that similar signs might be used on ramps and at ramp terminals where smaller letter heights and the number of messages might differ from the provisions of this Section.

Guidance:

To the extent practical, the design and application of changeable message signs should conform to the general principles of this Manual. Within the context of Section 2A.07, these practices should be followed for mainline freeway and expressway applications:

- A. Changeable message signs should be capital letters and have a desirable letter size of 450 mm (18 in) or a minimum letter size of 265 mm (10.6 in). Signs should be limited to not more than three lines with not more than 20 characters per line.
- B. No more than two displays should be used within any message cycle.
- C. Each display should convey a single thought.
- D. The entire message cycle should be readable at least twice by drivers traveling at the posted speed, the off-peak 85th-percentile speed, or the operating speed.

Standard:

Messages shall be centered within each line of legend. If more than one changeable message sign is visible to road users, then only one such sign shall display a sequential message at any given time.

A three-line changeable message sign shall be limited to not more than two messages. Techniques of message display such as fading, exploding, dissolving, or moving messages shall not be used.

Section 2E.22 Overhead Sign Installations**Support:**

Specifications for the design and construction of structural supports for highway signs have been standardized by the American Association of State Highway and Transportation Officials (AASHTO). Overcrossing structures can often serve for the support of overhead signs, and might in some cases be the only practical location that will provide adequate viewing distance. Use of these structures as sign supports will eliminate the need for additional sign supports along the roadside. Factors justifying the installation of overhead signs are given in Section 2A.17. Vertical clearance of overhead signs is discussed in Section 2A.18.

Section 2E.23 Lateral Clearance**Standard:**

The minimum lateral clearance outside the usable roadway shoulder for expressway and freeway signs mounted at the roadside or for overhead sign supports, either to the right or left side of the roadway, shall be 1.8 m (6 ft). This minimum clearance shall also apply outside of a barrier curb. If located within the clear zone, the signs shall be mounted on crashworthy supports or shielded by appropriate crashworthy barriers.

Guidance:

Where practical, a sign should not be less than 3 m (10 ft) from the edge of the nearest traffic lane. Large guide signs especially should be farther removed, preferably 9 m (30 ft) or more from the nearest traffic lane.

Where an expressway median is 3.7 m (12 ft) or less in width, consideration should be given to spanning both roadways without a center support.

Where overhead sign supports cannot be placed a safe distance away from the line of traffic or in an otherwise protected site, they should either be designed to minimize the impact forces, or be adequately shielded by a physical barrier or guardrail of suitable design.

Standard:

Butterfly-type sign supports and other overhead non-crashworthy sign supports shall not be installed in gores or other unprotected locations within the clear zone.

Option:

Lesser clearances, but not generally less than 1.8 m (6 ft), may be used on connecting roadways or ramps at interchanges.

Section 2E.24 Guide Sign Classification**Support:**

Freeway and expressway guide signs are classified and treated in the following categories:

- A. Route signs and Trailblazer Assemblies (see Section 2E.25).
- B. At-Grade Intersection signs (see Section 2E.26).
- C. Interchange signs (see Sections 2E.27 through 2E.36).
- D. Interchange Sequence Series signs (see Section 2E.37).
- E. Community Interchanges Identification signs (see Section 2E.38).
- F. NEXT X EXITS signs (see Section 2E.39).
- G. General Service signs (see Section 2E.51).
- H. Rest and Scenic Area signs (see Section 2E.52).

- I. Tourist Information and Welcome Center signs (see Section 2E.53).
- J. Reference Posts (see Section 2E.54).
- K. Miscellaneous guide signs (see Section 2E.55).
- L. Radio Information signs (see Section 2E.56).
- M. Carpool Information signs (see Section 2E.57).
- N. Weigh Station signs (see Section 2E.58).
- O. Specific Service signs (see Chapter 2F).
- P. Recreation and Cultural Interest signs (see Chapter 2H).

Section 2E.25 Route Signs and Trailblazer Assemblies

Standard:

The official Route sign for the Interstate Highway System shall be the red, white, and blue retroreflective distinctive shield adopted by the American Association of State Highway and Transportation Officials (see Section 2D.11).

Guidance:

Route signs should be incorporated as cut-out shields or other distinctive shapes on large directional guide signs. Where the Interstate shield is displayed in an assembly or on the face of a guide sign with U.S. or State Route signs, the Interstate numeral should be at least equal in size to the numerals on the other Route signs. The use of independent Route signs should be limited primarily to route confirmation assemblies.

Route signs and auxiliary signs showing junctions and turns should be used for guidance on approach roads, for route confirmation just beyond entrances and exits, and for reassurance along the freeway or expressway. When used along the freeway or expressway, the Route signs should be enlarged as shown in the "Standard Highway Signs" book. When independently-mounted Route signs are used in place of Pull-Through signs, they should be located just beyond the exit.

Option:

The standard Trailblazer Assembly (see Section 2D.32) may be used on roads leading to the freeway or expressway. Component parts of the Trailblazer Assembly may be included on a single sign panel. Independently-mounted Route signs may be used instead of Pull-Through signs

FOR GUIDE SIGN AND INDEPENDENT USE



FOR GUIDE SIGN USE



FOR INDEPENDENT USE



as confirmation information (see Section 2E.11). The commonly used name or trailblazer symbol for a toll facility may be displayed on non-toll sections of the Interstate Highway System at:

- A. The last exit before entering a toll section of the Interstate Highway System;
- B. The interchange or connection with a toll facility, whether or not the toll facility is a part of the Interstate Highway System; and
- C. Other locations within a reasonable approach distance of toll facilities when the name or trailblazer symbol for the toll facility would provide better guidance to road users unfamiliar with the area than would place names and route numbers.

The toll facility name or symbol may be included as a part of the guide sign installations on intersecting highways and approach roads to indicate the interchange with a toll section of an Interstate route. Where needed for the proper direction of traffic, a trailblazer for a toll facility that is part of the Interstate Highway System may be displayed with the Interstate Trailblazer Assembly.

Section 2E.26 Signs for Intersections At Grade

Guidance:

If there are intersections at grade within the limits of an expressway, sign types specified in Chapter 2D should be used. However, such signs should be of a size compatible with the size of other signing on the expressway.

Option:

Advance Guide signs for intersections at grade may take the form of diagrammatic layouts depicting the geometrics of the intersection along with essential directional information.

Section 2E.27 Interchange Guide Signs

Standard:

The signs at interchanges and on their approaches shall include Advance Guide signs and Exit Direction signs. Consistent destination messages shall be displayed on these signs.

Guidance:

New destination information should not be introduced into the major sign sequence for one interchange, nor should destination information be dropped.

Reference should be made to Section 2E.11 and Sections 2E.30 through 2E.39 for a detailed description of the signs in the order that they should appear at the approach to and beyond each interchange. Guide signs placed in advance of an interchange deceleration lane should be spaced at least 240 m (800 ft) apart.

Supplemental guide signing should be used sparingly as provided in Section 2E.32.

Section 2E.28 Interchange Exit Numbering

Support:

Interchange exit numbering provides valuable orientation for the road user on a freeway or expressway. The feasibility of numbering interchanges or exits on an expressway will depend largely on the extent to which grade separations are provided. Where there is appreciable continuity of interchange facilities, interrupted only by an occasional intersection at grade, the numbering will be helpful to the expressway user.

Standard:

Interchange numbering shall be used in signing each freeway interchange exit. Interchange exit numbers shall be displayed with each Advance Guide sign, Exit Direction sign, and Gore sign. The exit number shall be displayed on a separate plaque at the top of the Advance Guide or Exit Direction sign. The standard exit number plaque shall include the word EXIT, the appropriate exit number, and the suffix letter A or B (on multi-exit interchanges) in a single-line format on a plaque 750 mm (30 in) in height. Minimum numeral and letter sizes are given in Tables 2E-1 through 2E-4. If used, the interchange numbering system for expressways shall conform to the provisions prescribed for freeways.

Option:

There are two approaches to interchange exit numbering that the State and local highway agencies may use: (1) reference post numbering, or (2) consecutive numbering.

Support:

Reference post exit numbering is preferred over consecutive exit numbering for two reasons: (1) if new interchanges are added to a route, the highway agencies do not have to change the numbering sequence; and (2) reference post numbering assists road users in determining their destination distances and travel mileage.

Exit numbers may also be used with Supplemental Guide signs and Road User Service signs.

Guidance:

Exit number plaques should be located toward the top left edge of the sign for a left exit and toward the top right edge for right exits.

Option:

The word LEFT may be added to the exit number plaque (see Figure 2E-3).

Support:

The general plan for numbering interchange exits is shown in Figures 2E-10 through 2E-12.

Details of typical exit number plaque designs are shown in Figures 2E-3 and 2E-13. Figures 2E-1, 2E-18, 2E-21, 2E-25 through 2E-30, and 2E-34 illustrate the incorporation of exit number plaques on guide signs.

Standard:

Where a route originates within a State, the southernmost or westernmost terminus shall be the beginning point for numbering. If a loop, spur, or circumferential route crosses State boundaries, the sequence of numbering shall be coordinated by the States to provide continuous numbering.

For circumferential routes, the numbering of interchanges shall be in a clockwise direction. The numbering shall begin with the first interchange west of the south end of an imaginary north-south line bisecting the circumferential route, at a radial freeway or other Interstate route, or some other conspicuous landmark in the circumferential route near a south polar location (see Figure 2E-10). The interchange numbers on loop routes shall begin at the loop interchange nearest the south or west mainline junction and increase in magnitude toward the north or east mainline junction (see Figure 2E-11). Spur route interchanges shall be numbered in ascending order starting at the interchange where the spur leaves the mainline of the principal route (see Figure 2E-11).

Where numbered routes overlap, continuity of interchange numbering shall be established for only one of the routes (see Figure 2E-12). If one of the routes is an Interstate, the Interstate route shall maintain continuity of interchange numbering.

Guidance:

The route chosen for continuity of interchange numbering should also have reference post continuity (see Figure 2E-12).

Figure 2E-10. Typical Interchange Numbering for Mainline and Circumferential Routes

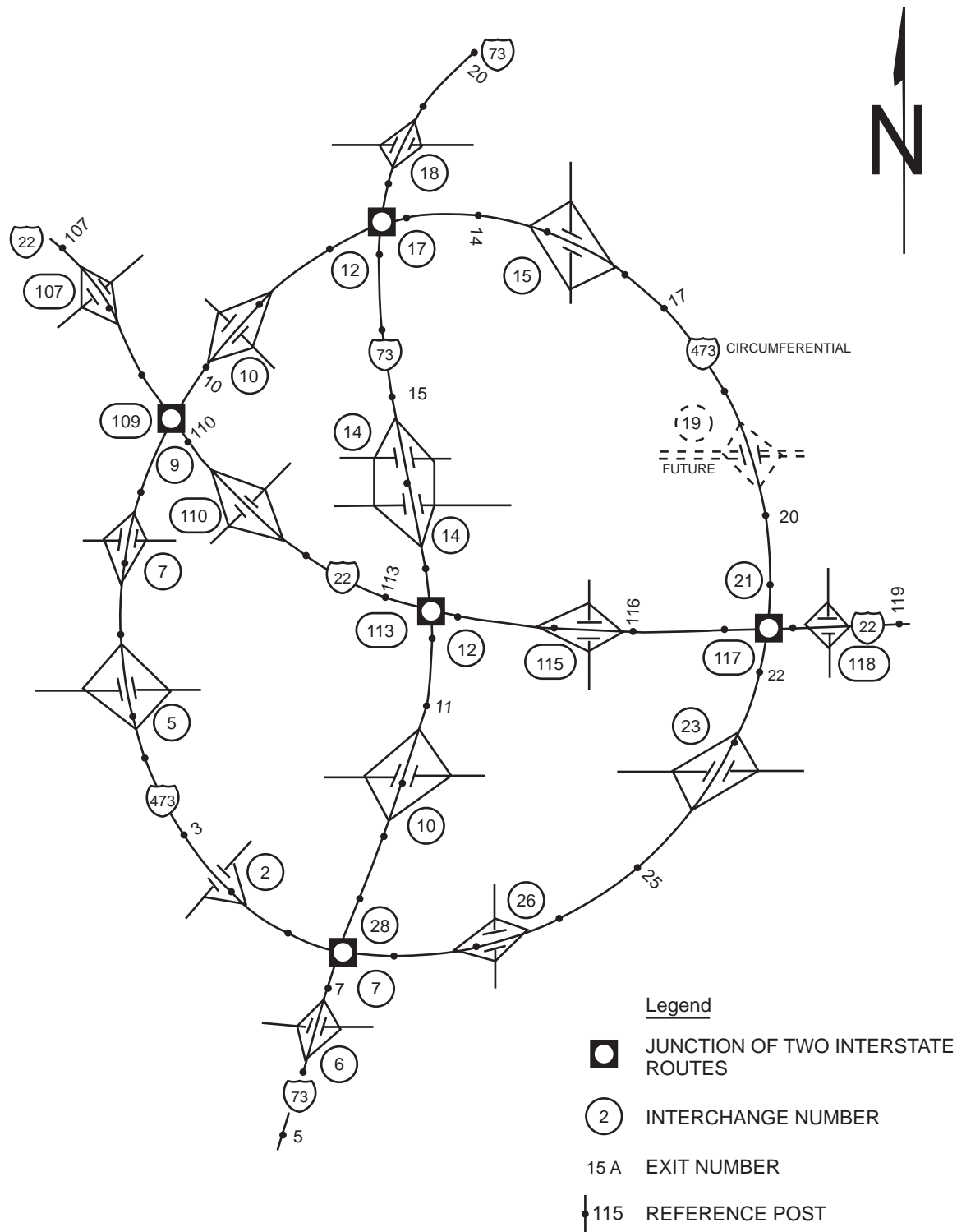

Figure 2E-11. Typical Interchange Numbering for Mainline, Loop, and Spur Routes

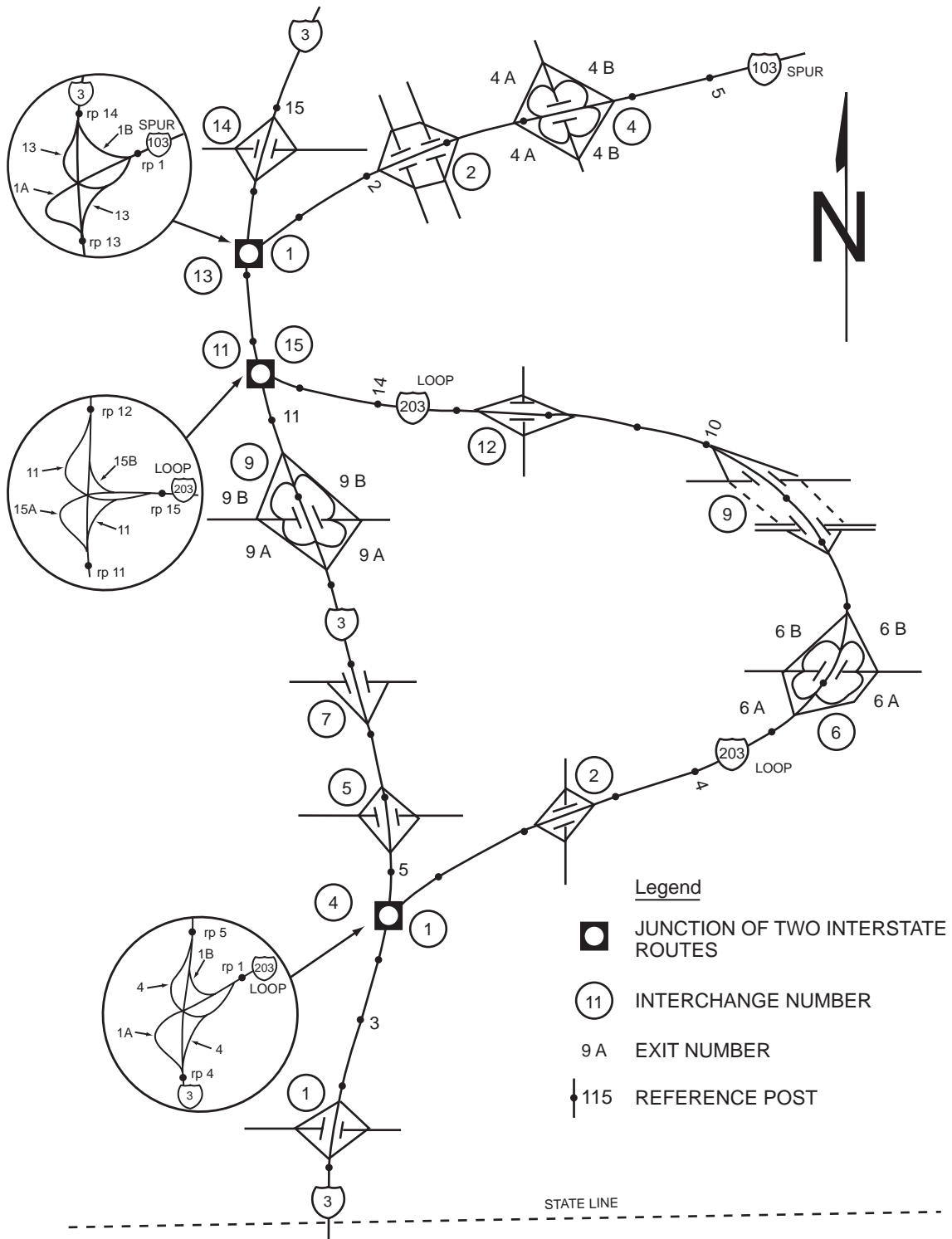
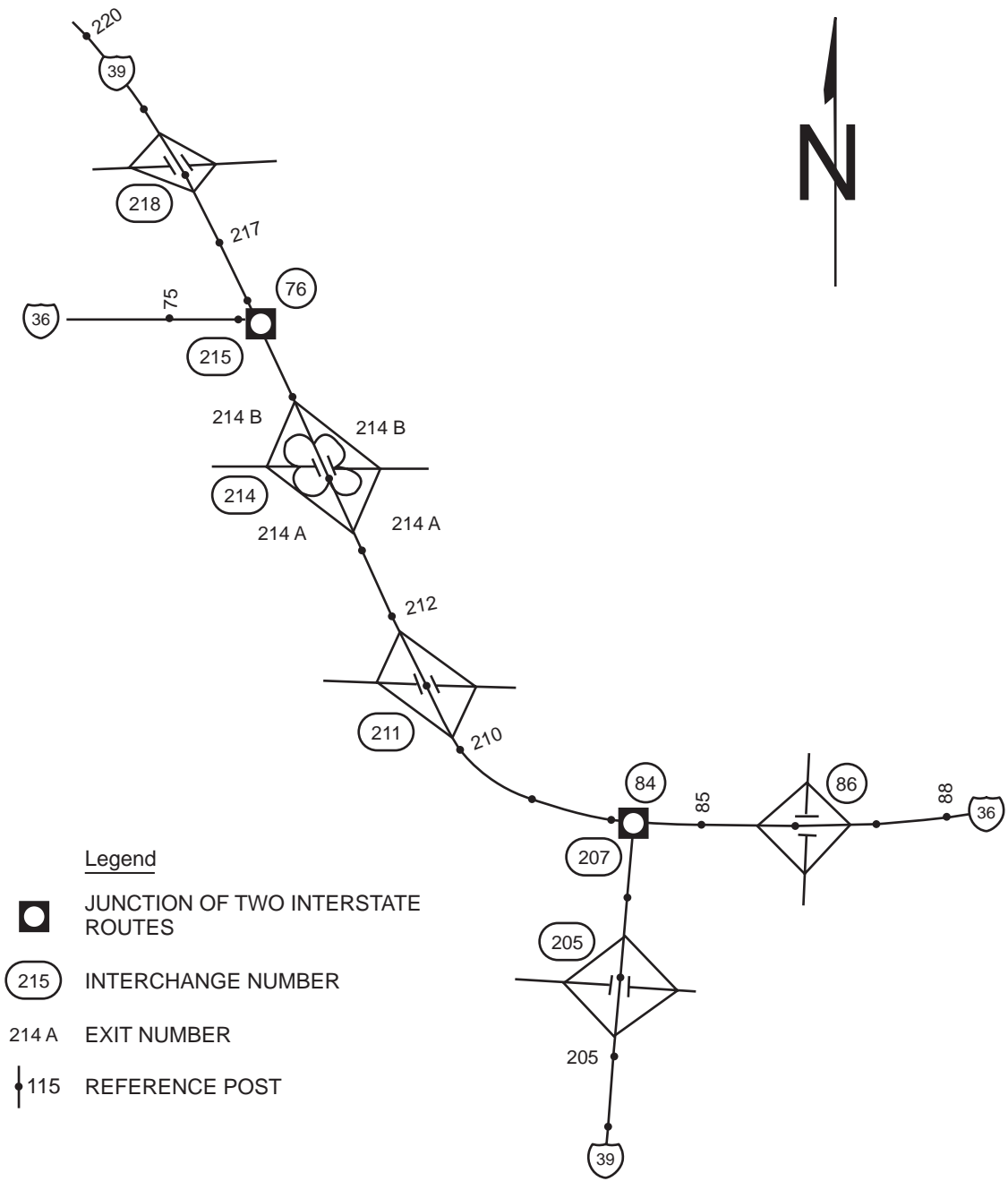

Figure 2E-12. Typical Interchange Numbering If Routes Overlap



Section 2E.29 Interchange Classification

Support:

For signing purposes, interchanges are classified as major, intermediate, and minor. The minimum alphabet sizes contained in Tables 2E-1 and 2E-3 are based on this classification. Descriptions of these classifications are as follows:

- A. Major interchanges are subdivided into two categories: (a) interchanges with other expressways or freeways, or (b) interchanges, other than those named in (a), with high-volume multi-lane highways, principal urban arterials, and major rural routes where the volume of interchanging traffic is heavy or includes many road users unfamiliar with the area.
- B. Intermediate interchanges are those with urban and rural routes not in the category of major or minor interchanges as defined herein.
- C. Minor interchanges include those where traffic is local and very light, such as interchanges with land service access roads. Where the sum of exit volumes is estimated to be lower than 100 vehicles per day in the design year, the interchange is classified as minor.

Section 2E.30 Advance Guide Signs

Support:

The Advance Guide sign gives notice well in advance of the exit point of the principal destinations served by the next interchange and the distance to that interchange (see Figure 2E-13).

Guidance:

For major and intermediate interchanges (see Section 2E.29), two and preferably three Advance Guide signs should be used. Placement should be 1 km (0.5 mi), 2 km (1 mi), and 4 km (2 mi) in advance of the exit. At minor interchanges, only one Advance Guide sign should be used. It should be located 1 to 2 km (0.5 to 1 mi) from the exit gore. If the sign is located less than 1 km (0.5 mi) from the exit, the distance shown should be to the nearest 400 m (0.25 mi). Fractions of kilometers or decimals of kilometers should not be used. Fractions of a mile, rather than decimals, should be shown in all cases.

Where Advance Guide signs are for a left exit, diagrammatic signs should be used (see Figure 2E-3).

Figure 2E-13. Typical Interchange Advance Guide Signs



E1-1



E1-1a

Note: Delete word EXIT(S) if exit number is used.



E1-2



E1-2



E1-5
EXIT NUMBER PLAQUE

Standard:

When used, the 2 km (1 mi) and 4 km (2 mi) Advance Guide signs shall contain the distance message. The legend on the Advance Guide signs shall be the same as the legend on the Exit Direction sign, except that the last line shall read EXIT X KM (EXIT X MILES). If the interchange has two or more exit roadways, the bottom line shall read EXITS X KM (EXITS X MILES).

Option:

Where interchange exit numbers are used, the word EXIT may be omitted from the bottom line. Where the distance between interchanges is more than 2 km (1 mi), but less than 4 km (2 mi), the first Advance Guide sign may be closer than 4 km (2 mi), but not placed so as to overlap the signing for the previous exit. Duplicate Advance Guide signs or Interchange Sequence Series signs may be placed in the median on the opposite side of the roadway and are not included in the minimum requirements of interchange signing.

Guidance:

Where there is less than 240 m (800 ft) between interchanges, Interchange Sequence Series signs should be used instead of Advance Guide signs for the affected interchanges.

Section 2E.31 Next Exit Supplemental Sign**Option:**

Where the distance to the next interchange is unusually long, Next Exit supplemental signs may be installed to inform road users of the distance to the next interchange (see Figure 2E-14).

Guidance:

The Next Exit supplemental sign should not be used unless the distance between successive interchanges is more than 8 km (5 mi).

Standard:

The Next Exit supplemental sign shall carry the legend NEXT EXIT X KM (X MILES). If the Next Exit supplemental sign is used, it shall be placed below the Advance Guide sign nearest the interchange. It shall be mounted so as to not adversely affect the breakaway feature of the sign support structure.

Figure 2E-14. Next Exit Supplemental Advance Guide Signs



E2-1



E2-1A

Option:

The legend for the Next Exit supplemental sign may be displayed in either one or two lines. The one-line message is the more desirable choice unless the message causes the sign to have a horizontal dimension greater than that of the Advance Guide sign.

Section 2E.32 Other Supplemental Guide Signs

Support:

Supplemental Guide signs can be used to provide information regarding destinations accessible from an interchange, other than places shown on the standard interchange signing. However, such Supplemental Guide signing can reduce the effectiveness of other more important guide signing because of the possibility of overloading the road user's capacity to receive visual messages and make appropriate decisions. "The AASHTO Guidelines for the Selection of Supplemental Guide Signs for Traffic Generators Adjacent to Freeways" is incorporated by reference in this section (see Page i for AASHTO's address).

Standard:

No more than one Supplemental Guide sign shall be used on each interchange approach.

Guidance:

A Supplemental Guide sign (see Figure 2E-15) should not list more than two destinations. Destination names should be followed by the interchange number (and suffix), or if interchanges are not numbered, by the legend NEXT RIGHT or SECOND RIGHT or both, as appropriate. The Supplemental Guide sign should be installed as an independent guide sign assembly.

Where two or more Advance Guide signs are used, the Supplemental Guide sign should be installed approximately midway between two of the Advance Guide signs. If only one Advance Guide sign is used, the Supplemental Guide sign should follow it by at least 240 m (800 feet). If the interchanges are numbered, the interchange number should be used for the action message.

States and other agencies should adopt an appropriate policy for installing supplemental signs using the "The AASHTO Guidelines for the Selection of Supplemental Guide Signs for Traffic Generators Adjacent to Freeways." In developing policies for such signing, such items as population, amount of traffic generated, distance from the route, and the significance of the destination should be taken into account.

Standard:

Guide signs directing drivers to park and ride facilities shall be considered as Supplemental Guide signs (see Figures 2E-16 and 2E-17).

Section 2E.33 Exit Direction Signs

Support:

The Exit Direction sign repeats the route and destination information that was shown on the Advance Guide sign(s) for the next exit, and thereby assures road users of the destination served and indicates whether they exit to the right or the left for that destination.

Standard:

Exit Direction signs shall be used at major and intermediate interchanges. Population figures or other similar information shall not be used on Exit Direction signs.

Figure 2E-15. Supplemental Guide Signs for Multi-Exit Interchanges



**Figure 2-16. Supplemental Guide Sign for a Park and Ride Facility
(Route without Exit Numbering)**



**Figure 2E-17. Supplemental Guide Sign for a Park and Ride Facility
(Route with Exit Numbering)**



Figure 2E-18. Interchange Exit Direction Sign



Guidance:

Exit Direction signs should be used at minor interchanges.

Ground-mounted Exit Direction signs should be installed at the beginning of the deceleration lane. If there is less than 90 m (300 ft) from the beginning of the deceleration lane to the theoretical gore (see Figure 3B-8), the Exit Direction sign should be installed overhead over the exiting lane in the vicinity of the theoretical gore.

Standard:

Where a through lane is being terminated (dropped) at an exit, the Exit Direction sign shall be placed overhead at the theoretical gore (see Figures 2E-8 and 2E-9).

The following provisions shall govern the design and application of the overhead Exit Direction sign:

- A. The sign shall carry the exit number (if used), the route number, cardinal direction, and destination with an appropriate upward slanting arrow (see Figure 2E-18).**
- B. The message EXIT ONLY in black on a yellow panel shall be used on the overhead Exit Direction sign to advise road users of a lane drop situation. The sign shall conform to the provisions of Section 2E.20.**
- C. Diagrammatic signs shall not be employed at the exit direction location.**

Guidance:

Exit number plaques should be located toward the left edge of the sign for a left exit and toward the right edge for right exits.

Option:

In some cases, principally in urban areas, where restricted sight distance because of structures or unusual alignment make it impossible to locate the Exit Direction sign without violating the required minimum spacing (see Section 2E.30) between major guide signs, Interchange Sequence signs (see Section 2E.37) may be substituted for an Advance Guide sign.

Guidance:

At multi-exit interchanges, the Exit Direction sign should be located directly over the exiting lane for the first exit. At the same location, and normally over the right through lane, an Advance Guide sign for the second exit should be located. Only for those

conditions where the through movement is not evident should a confirmatory message (Pull-Through sign as shown in Figure 2E-2) be used over the left lane(s) to guide road users traveling through an interchange. In the interest of sign spreading, three signs on one structure should not be used. When the freeway or expressway is on an overpass, the Exit Direction sign should be installed on an overhead support over the exit lane in advance of the gore point.

Option:

If the second exit is beyond an underpass, the Exit Direction sign may be mounted on the face of the overhead structure.

Section 2E.34 Exit Gore Signs

Support:

The Exit sign in the gore indicates the place of departure from the main roadway. Consistent application of this sign at each exit is important. The basic need is for a sign to indicate the exiting point.

Guidance:

Each gore should be treated similarly, whether the interchange has one exit roadway or multiple exits.

Standard:

The Exit sign in the gore shall be located in the area between the main roadway and the ramp at all exits. The sign shall carry the word EXIT or EXIT XX (if interchange numbering is used) and an appropriate upward slanting arrow (see Figure 2E-19). Breakaway or yielding supports shall be used.

Guidance:

The arrow should be aligned to approximate the angle of departure.

Section 2E.35 Post-Interchange Signs

Guidance:

If space between interchanges permits, as in rural areas, and where undue repetition of messages will not occur, a fixed sequence of signs should be displayed beginning 150 m (500 ft) beyond the end of the acceleration lane. At this point a Route sign

Figure 2E-19. Exit Gore Signs



E5-1



E5-1a

Figure 2E-20. Post-Interchange Distance Sign

E7

assembly should be installed followed by a Speed Limit sign and a Distance sign, each at a spacing of 300 m (1,000 ft).

If space between interchanges does not permit placement of these three post-interchange signs without encroaching on or overlapping the Advance Guide signs necessary for the next interchange, or in rural areas where the interchanging traffic is primarily local, one or more of the post-interchange signs should be omitted.

Option:

Usually the Distance sign will be of less importance than the other two signs and may be omitted, especially if Interchange Sequence signs are used. If the sign for through traffic on an overhead assembly already contains the route sign, the post-interchange route sign assembly may also be omitted.

Section 2E.36 Distance Signs

Standard:

If used, the post-interchange Distance sign shall consist of a two- or three-line sign carrying the names of significant destination points and the distances to those points. The top line of the sign shall identify the next meaningful interchange with the name of the community near or through which the route passes, or if there is no community, the route number or name of the intersected highway (see Figure 2E-20).

Guidance:

If a second line is used, it should be reserved for communities of general interest that are located on or immediately adjacent to the route or for major traffic generators along the route.

Option:

The choice of names for the second line, if it is used, may be varied on successive Distance signs to give road users maximum information concerning communities served by the route.

Standard:

The third, or bottom line, shall contain the name and distance to a control city (if any) that has national significance for travelers using the route.

Guidance:

Distances to the same destinations should not be shown more frequently than at 8 km (5 mi) intervals. The distances displayed on these signs should be the actual distance to the destination points and not to the exit from the freeway or expressway.

Section 2E.37 Interchange Sequence Signs**Guidance:**

If there is less than 240 m (800 ft) between interchanges, Interchange Sequence signs should be used instead of the Advance Guide signs for the affected interchanges. If used, Interchange Sequence signs should be used over the entire length of a route in an urban area. They should not be used on a single interchange basis.

Option:

If interchanges are closely spaced, particularly through large urban areas, so that guide signs cannot be adequately spaced, Interchange Sequence signs identifying the next two or three interchanges may be used.

Support:

Interchange Sequence signs are generally supplemental to Advance Guide signs. Signing of this type is illustrated in Figures 2E-21 and 2E-22, and is compatible with the sign spreading concept.

These signs are installed in a series and display the next two or three interchanges by name or route number with distances to the nearest 400 m (0.25 mile).

Figure 2E-21. Signing of Closely-Spaced Interchanges Using Interchange Sequence Signs

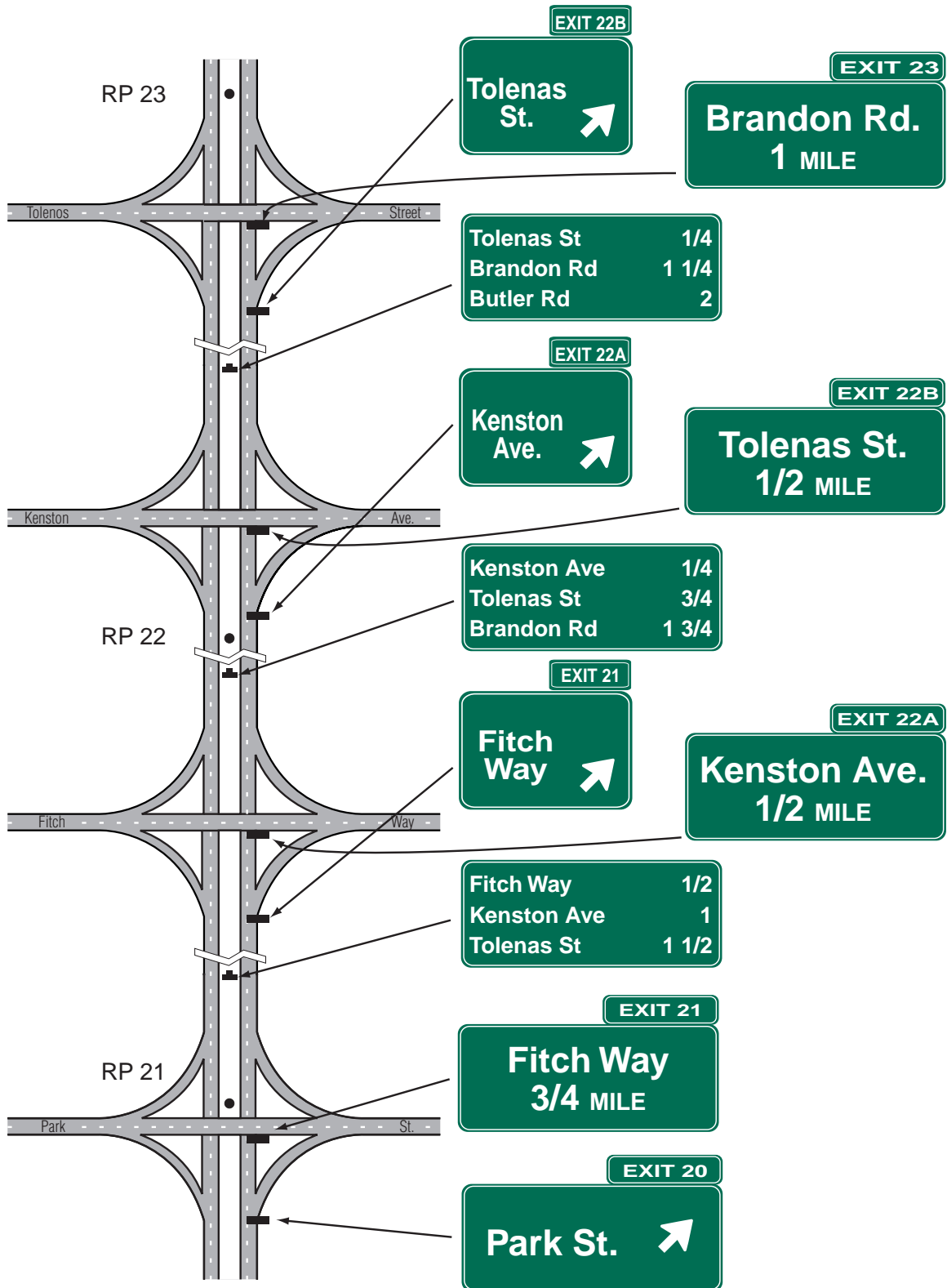

Figure 2E-22. Interchange Sequence Sign



Figure 2E-23. Community Interchanges Identification Sign

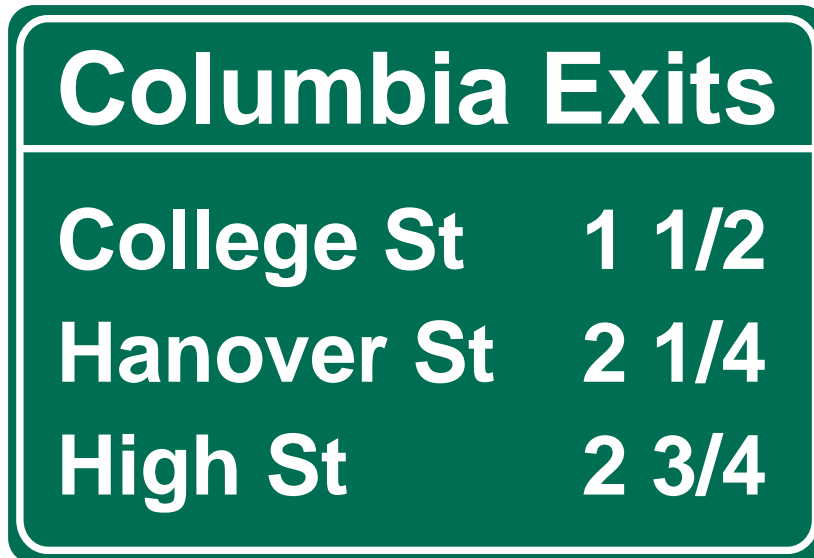

Figure 2E-24. NEXT EXITS Sign



Standard:

If used, the first sign in the series shall be located in advance of the first Advance Guide sign for the first interchange.

Where the exit direction is to the left, interchange names or route numbers shown on such signs shall be followed by the legend LEFT or LEFT EXIT in black letters on a yellow rectangular background.

Interchange Sequence signs shall not be substituted for Exit Direction signs.

Guidance:

Interchange Sequence signs should be located in the median. After the first of the series, Interchange Sequence signs should be placed approximately midway between interchanges.

Standard:

Interchange Sequence signs located in the median shall be installed at overhead sign height.

Option:

Interchange numbers may be shown to the left of the interchange name or route number.

Section 2E.38 Community Interchanges Identification Signs**Support:**

For suburban or rural communities served by two or three interchanges, Community Interchanges Identification signs are useful (see Figure 2E-23).

Guidance:

In these cases, the name of the community followed by the word Exits should be shown on the top line; the lines below should display the destination, road name or route number, and the corresponding distances to the nearest 400 m (0.25 mile).

The sign should be located in advance of the first Advance Guide sign for the first interchange within the community.

Option:

If interchanges are not conveniently identifiable or if there are more than three interchanges to be identified, the NEXT X EXITS sign (see Section 2E.39) may be used.

Section 2E.39 NEXT X EXITS Signs

Support:

Many freeways or expressways pass through historical or recreational regions, or urban areas served by a succession of several interchanges.

Option:

Such regions or areas may be indicated by a NEXT X EXITS sign (see Figure 2E-24) located in advance of the Advance Guide sign or signs for the first interchange.

Guidance:

The sign legend should identify the region or area followed by the words NEXT X EXITS.

Section 2E.40 Signing by Type of Interchange

Support:

Road users need signs to help identify the location of the exit, as well as to obtain route, direction, and destination information for specific exit ramps. Figures 2E-25 through 2E-30 show applications of guide signs for common types of interchanges. The interchange layouts shown in most of the figures illustrate only the major guide signs for one direction of traffic on the through road and on the crossroad.

Standard:

Interchange guide signing shall be consistent for each type of interchange along a route.

Guidance:

The signing layout for all interchanges having only one exit ramp in the direction of travel should be similar, regardless of the interchange type (see Figures 2E-8, 2E-9, and Figures 2E-25 through 2E-30). For the sake of uniform application, the significant features of the signing plan for each of the more frequent kinds of interchanges

(illustrated in Figures 2E-25 through 2E-30) should be followed as closely as possible. Even when unusual geometric features exist, variations in signing layout should be held to a minimum.

Section 2E.41 Freeway-to-Freeway Interchange

Support:

Freeway-to-freeway interchanges are major decision points where the effect of taking a wrong ramp cannot be easily corrected. Reversing direction on the connecting freeway or reentering to continue on the intended course is usually not possible. Figure 2E-25 shows typical applications of guide signs at a freeway-to-freeway interchange.

Guidance:

The sign messages should contain only the route shield, cardinal direction, and the name of the next control city on the route. Arrows should point as indicated in Section 2D.08, unless a diagrammatic representation of the interchange layout requires otherwise.

At splits where the off-route movement is to the left or where there is an optional lane split, expectancy problems usually result, and diagrammatic signs should be used at the Advance Guide sign location. Diagrammatic signs (see Section 2E.19) also should be used at the Advance Guide sign locations for interchanges where two-lane exits with an optional lane carry the through route on the exiting lanes.

Standard:

Overhead signs shall be used at a distance of 2 km (1 mi) and at the theoretical gore of each connecting ramp. When diagrammatic signs are used, they shall conform to the provisions of Section 2E.19.

Option:

Overhead signs may also be used at the 1 km (0.5 mi) and 4 km (2 mi) points.

The arrow and/or the name of the control city may be omitted on signs that indicate the straight-ahead continuation of a route.

An Exit Speed sign may be used where an engineering study shows that it is necessary to display a speed reduction message for ramp signing (see Section 2C.33).

Figure 2E-25. Typical Freeway-to-Freeway Interchange Guide Signs



Section 2E.42 Cloverleaf Interchange

Support:

A cloverleaf interchange has two exits for each direction of travel. The exits are closely spaced and have common Advance Guide signs. Typical application of guide signs for cloverleaf interchanges is shown in Figure 2E-26.

Guidance:

The Advance Guide signs should include two place names, one corresponding to each exit ramp, with the name of the place served by the first exit on the upper line.

Standard:

An Overhead Guide sign shall be placed at the theoretical gore point of the first exit ramp, with an upward slanting arrow on the exit direction sign for that exit and the message XX KM (XX MILE) on the Advance Guide sign for the second exit, as shown in Figure 2E-26. The second exit shall be indicated by an overhead Exit Direction sign over the auxiliary lane. An Exit sign shall also be used at each gore (see Section 2E.34).

Interchanges with more than one exit from the main line shall be numbered as described in Section 2E.28 with an appropriate suffix. Exit numbers shall not include the cardinal initials corresponding to the directions of the cross route.

Diagrammatic signs shall not be used for cloverleaf interchanges.

Option:

As shown in Figure 2E-26, the overhead Exit Direction sign for the second exit may be mounted on the structure if the mainline passes under the crossroad and the exit roadway is located beyond the structure.

Section 2E.43 Cloverleaf Interchange with Collector-Distributor Roadways

Guidance:

Signing on the collector-distributor roadways should be the same as the signing on the mainline of a cloverleaf interchange.

Figure 2E-26. Typical Guide Signs for Full Cloverleaf Interchange

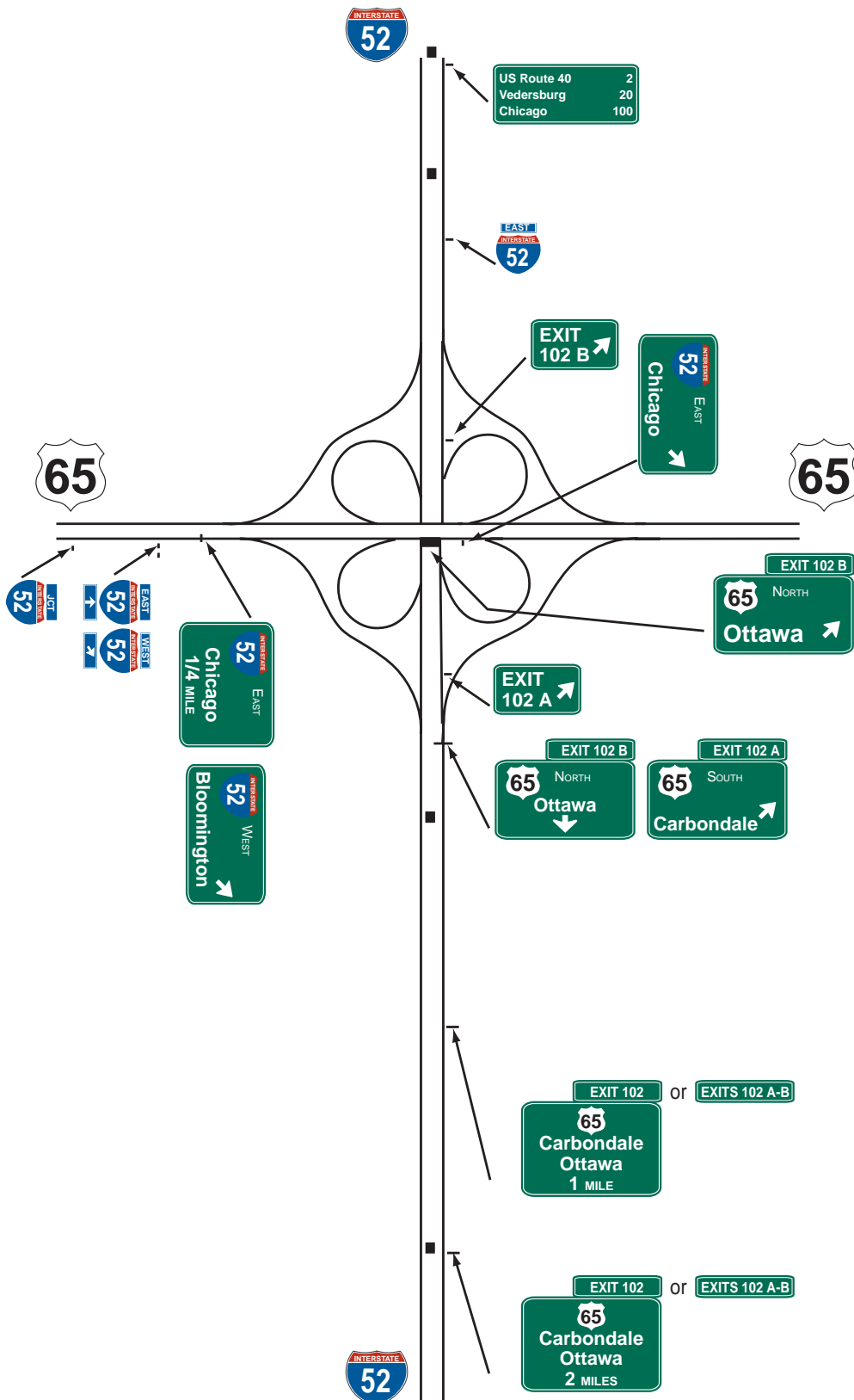

Standard:

Guide signs at exits from the collector-distributor roadways shall be overhead and located at the theoretical gore of the collector-distributor roadway and the exit ramp.

Option:

Exits from the collector-distributor roadways may be numbered with an appropriate suffix. The Advance Guide signs may include two place names and their corresponding exit numbers or may use the singular EXIT.

Section 2E.44 Partial Cloverleaf Interchange**Support:**

Typical application of guide signs for partial cloverleaf interchanges is shown in Figure 2E-27.

Guidance:

As shown in Figure 2E-27, the overhead Exit Direction sign should be placed on the structure if the mainline passes under the crossroad and the exit roadway is located beyond the structure.

Standard:

A ground-mounted Exit sign shall also be installed in the ramp gore.

Section 2E.45 Diamond Interchange**Support:**

Typical application of guide signs for diamond interchanges is shown in Figure 2E-28.

Standard:

The singular message EXIT shall be used on the Advance Guide and Exit Direction signs. Exit numbers shall not include the cardinal initials corresponding to the direction of the cross route.

Figure 2E-27. Typical Partial Cloverleaf Interchange Guide Signs

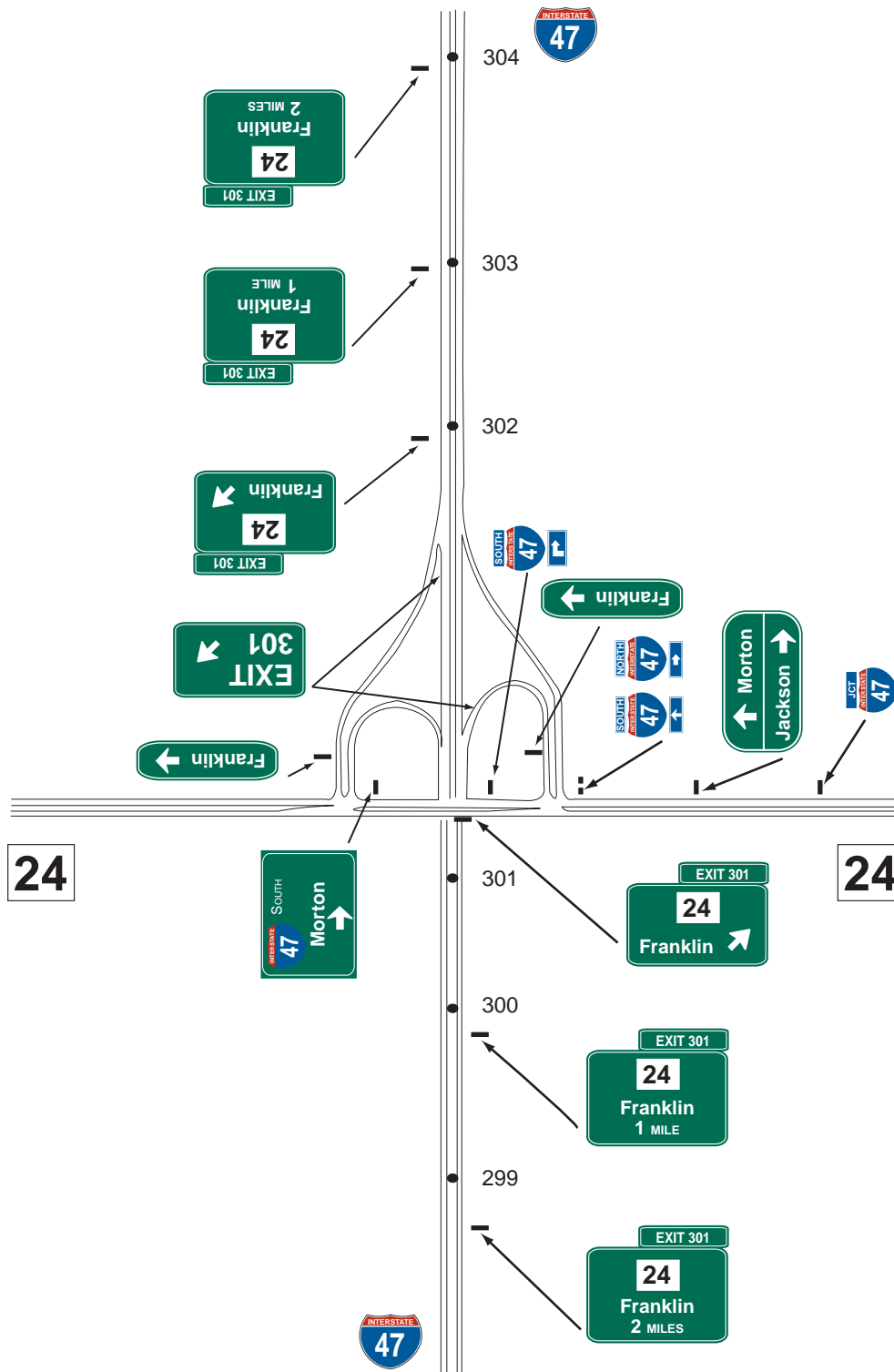
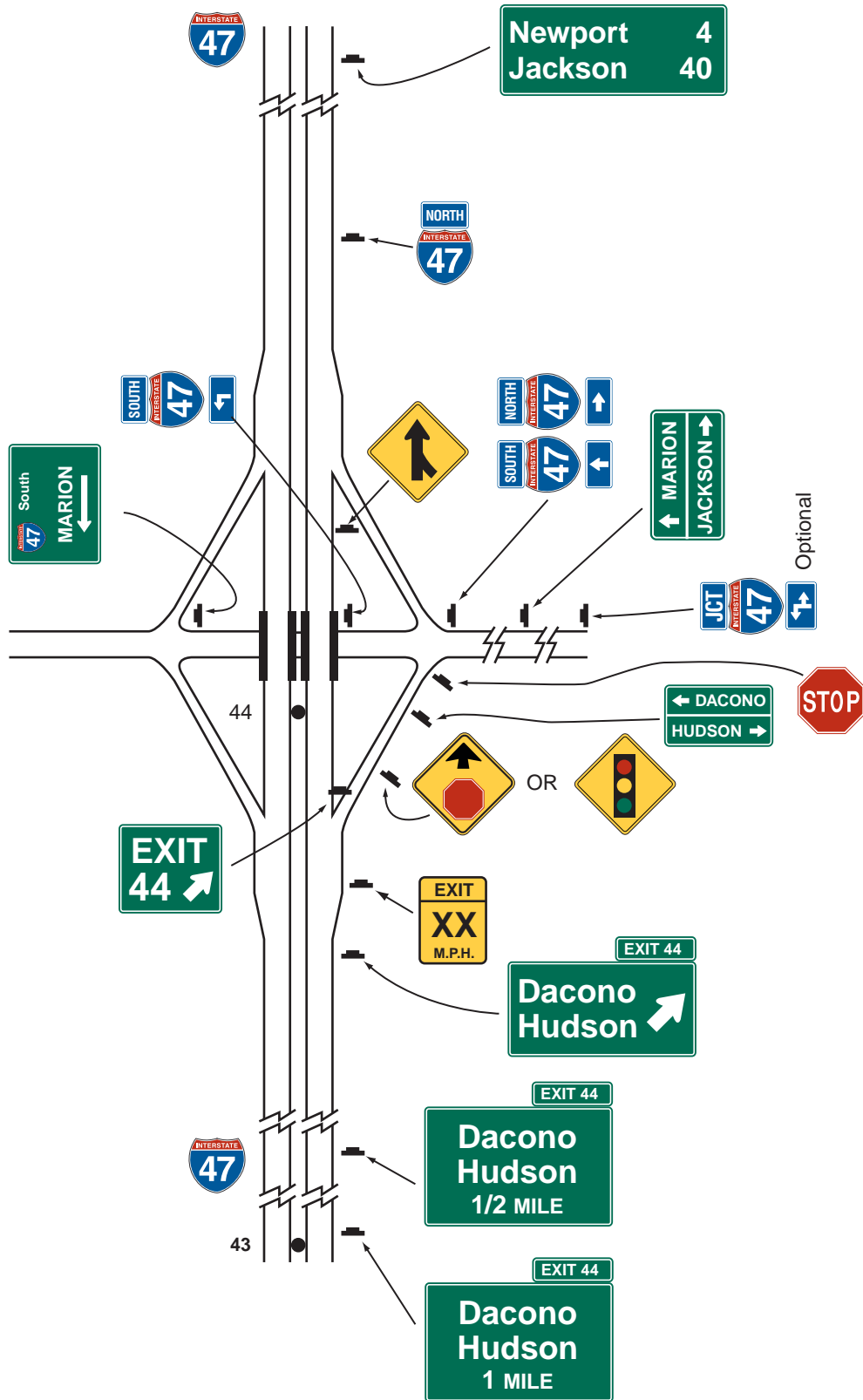

Figure 2E-28. Typical Diamond Interchange Guide Signs



Support:

The typical diamond interchange ramp departs from the mainline roadway such that a speed reduction generally is not necessary in order for a driver to safely negotiate an exit maneuver from the mainline onto the ramp roadway.

Guidance:

When a speed reduction is not necessary, an exit speed sign should not be used.

Option:

An Exit Speed sign may be used where an engineering study shows that it is necessary to display a speed reduction message for ramp signing (see Section 2C.33).

Guidance:

The Exit Speed sign should be located along the deceleration lane or along the ramp such that it is visible to the driver far enough in advance so that a safe slowing and exiting maneuver can be made.

Option:

A Stop Ahead or Signal Ahead warning sign may be placed, where engineering judgment indicates a need, along the ramp in advance of the cross street, to give notice to the driver (see Section 2C.26).

Guidance:

When used on two-lane ramps, Stop Ahead or Signal Ahead signs should be used in pairs with one sign on each side of the ramp.

Section 2E.46 Urban Diamond Interchange**Support:**

A typical application of guide signs for diamond interchanges in an urban area is shown in Figure 2E-29. This example includes the use of the Community Interchanges Identification sign (see Section 2E.38) which might be useful if two or more interchanges serve the same community.

In urban areas, street names are often shown as the principal message in destination signs.

Figure 2E-29. Typical Urban Diamond Interchange Guide Signs

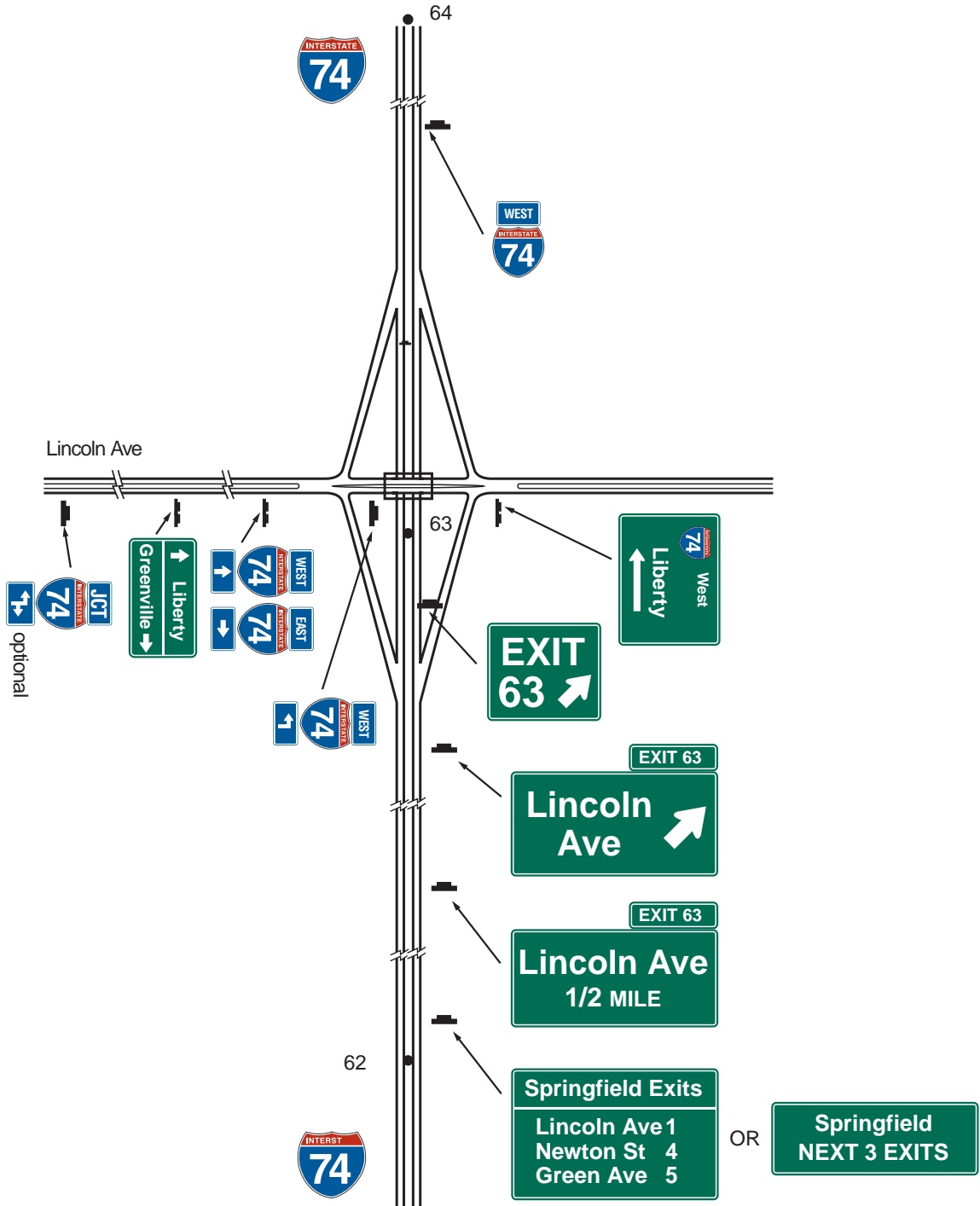

Option:

If interchanges are too closely spaced to properly locate the Advance Guide signs, they may be placed closer to the exit, and the distance figures adjusted accordingly.

Section 2E.47 Closely-Spaced Interchanges

Option:

When a series of interchanges is closely spaced, the advance guide sign for the next interchange may be mounted on an overhead structure located downstream from the gore of the preceding interchange.

Guidance:

Interchange Sequence signs should be used at closely-spaced interchanges. When used, they should identify and show street names and distances for the next two or three exits as shown in Figure 2E-21.

Standard:

Advance Guide signs for closely-spaced interchanges shall show information for only one interchange.

Section 2E.48 Minor Interchange

Option:

Less signing may be used for minor interchanges because such interchanges customarily serve low volumes of local traffic.

Support:

A typical application of guide signs for minor interchanges is shown in Figure 2E-30.

Standard:

At least one Advance Guide sign and an Exit Gore sign shall be placed at a minor interchange.

Guidance:

An Exit Direction sign should also be used.

Figure 2E-30. Typical Minor Interchange Guide Signs

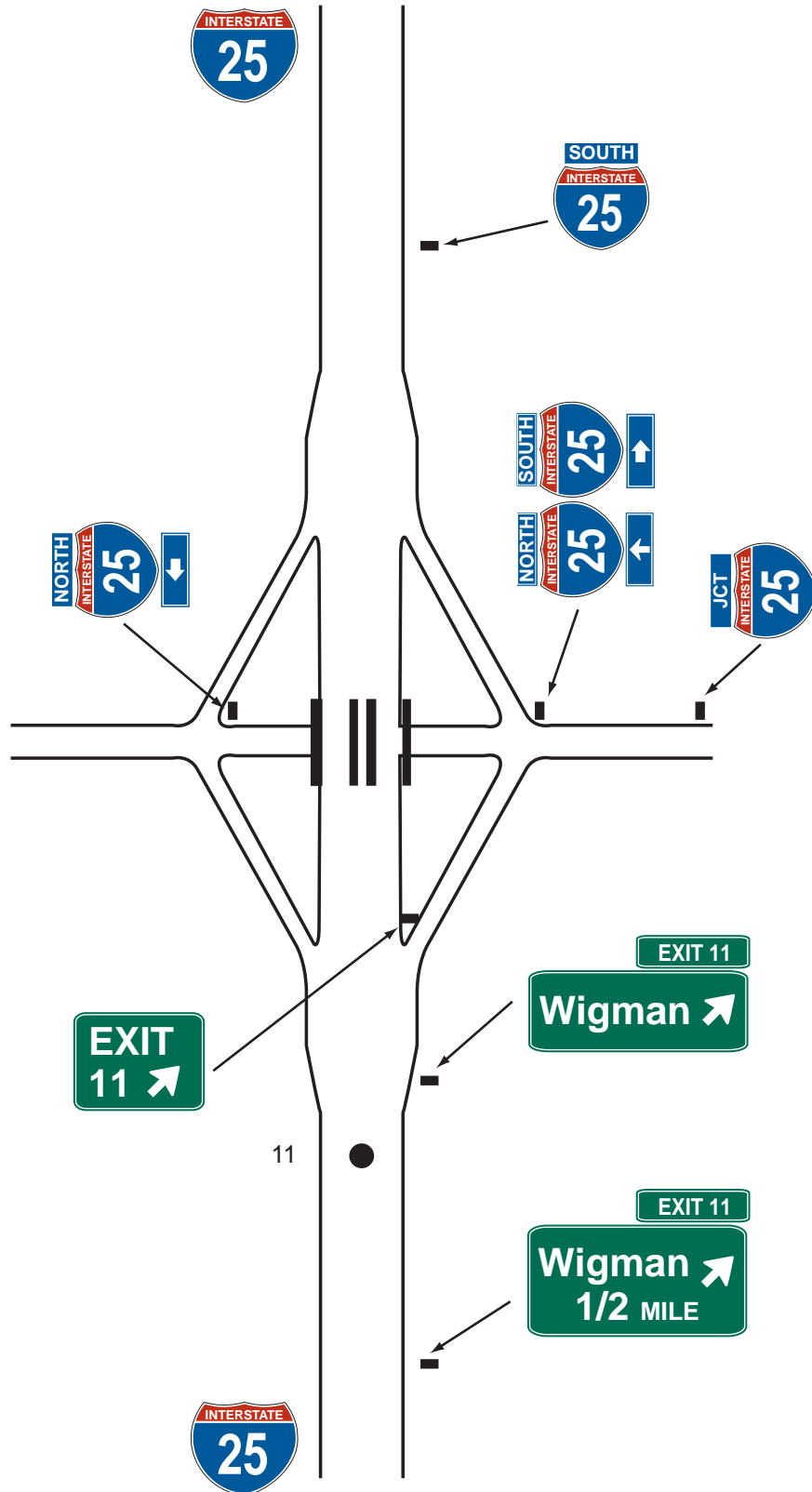

Section 2E.49 Approaches and Connecting Roadways

Guidance:

The identification of entrances to freeways and expressways from roads of lower classification should be given adequate attention. The freeway or expressway signing standards should be extended to the approach roadways because conventional guide signing on the approach roads, as described in Chapter 2D, might in some cases be ineffective for some of the more important interchanges.

Guide signing for frontage roads should be consistent with the requirements for freeways and expressways.

Engineering judgment should be used for signing ramp terminals to provide guidance to entrance ramps and to avoid giving road users confusing or conflicting information, or creating sight obstructions.

Section 2E.50 Wrong-Way Traffic Control At Interchange Ramps

Standard:

At interchange exit ramp terminals where the ramp intersects a crossroad in such a manner that wrong-way entry could inadvertently be made, the following signs shall be used (see Figure 2E-31):

- A. At least one ONE WAY sign for each direction of travel on the crossroad shall be placed where the exit ramp intersects the crossroad.**
- B. At least one DO NOT ENTER sign shall be conspicuously placed near the end of the exit ramp in positions appropriate for full view of a road user starting to enter wrongly.**
- C. At least one WRONG WAY sign shall be placed on the exit ramp facing a road user traveling in the wrong direction.**

Guidance:

In addition, the following pavement markings should be used:

- A. On two-lane paved crossroads at interchanges, double solid yellow lines should be used as a centerline for an adequate distance on both sides approaching the ramp intersections.**

Figure 2E-32. Typical Regulatory Signing and Pavement Markings at Entrance Ramp Terminal Where Design Does Not Clearly Indicate the Direction of Flow

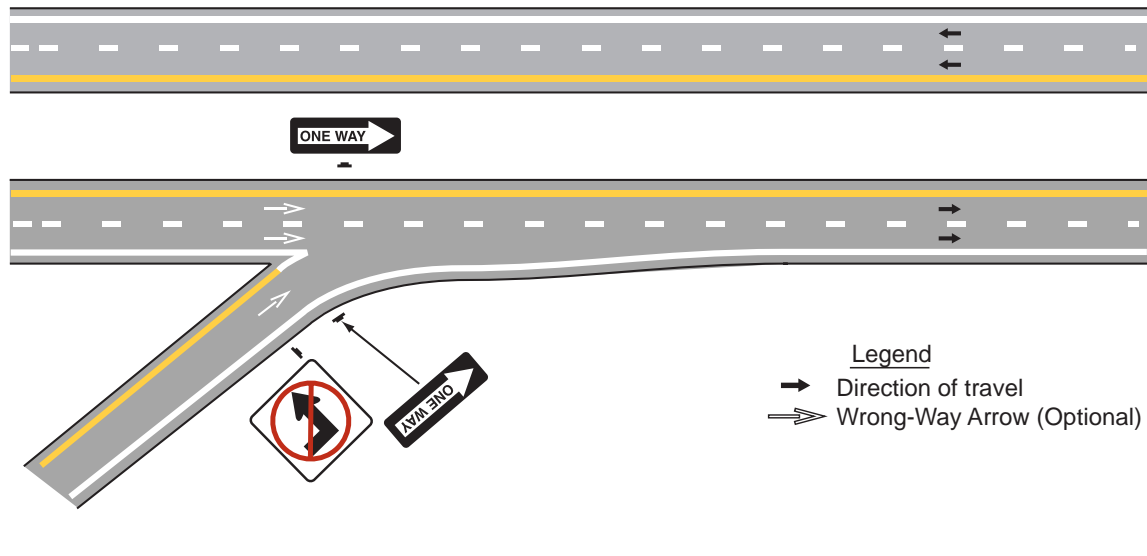

- D. Wrong-way arrow pavement markings may be placed on the exit ramp at appropriate locations near the crossroad junction to indicate wrong-way movement. Lane-use arrow pavement markings may be placed on the exit ramp and crossroad near their intersection to indicate the permissive direction of flow.
- E. Guide signs may be used on entrance ramps near the crossroad to inform road users of the freeway or expressway entrance, as appropriate.

Guidance:

On interchange entrance ramps where the ramp merges with the through roadway and the design of the interchange does not clearly make evident the direction of traffic on the separate roadways or ramps, a ONE WAY sign visible to traffic on the entrance ramp and through roadway should be placed on each side of the through roadway near the entrance ramp merging point as illustrated in Figure 2E-32.

Option:

At locations where engineering judgment determines that a special need exists, other standard warning or prohibitive methods and devices may be used as a deterrent to the wrong-way movement.

Support:

Sections 2A.24 and 2B.30 contain further information on signing to avoid wrong-way movements at at-grade intersections on expressways.

Section 2E.51 General Service Signs**Support:**

General Service signs are generally not appropriate at major interchanges (see Section 2E.29 for definition) and in urban areas.

Option:

If interchanges are not numbered, an action message such as NEXT RIGHT or SECOND RIGHT may be used (see Figure 2E-33).

Standard:

General Service signs shall have white letters, symbols, and borders on a blue background. Letter and numeral sizes shall conform to the minimum requirements of Tables 2E-1 through 2E-4. All approved symbols shall be permitted as alternatives to word messages, but symbols and word service messages shall not be intermixed. If the services are not visible from the ramp of a single-exit interchange, the service signing shall be repeated in smaller size at the intersection of the exit ramp and the crossroad. Such service signs shall use arrows to indicate the direction to the services.

Guidance:

Distance to services should be shown on General Service signs where distances are more than 2 km (1 mi).

General Service signing should only be provided at locations where the road user can return to the freeway or expressway and continue in the same direction of travel.

Only services that fulfill the needs of the road user should be shown on General Service signs. If State or local agencies elect to provide General Service signing, there should be a statewide policy for such signing and criteria for the availability of the various types of services. The criteria should consider the following:

- A. Gas, Diesel, LP Gas, EV Charging, and/or other alternative fuels if all of the following are available:
 - 1. Vehicle services such as gas, oil, and water;
 - 2. Modern sanitary facilities and drinking water;
 - 3. Continuous operations at least 16 hours per day, 7 days per week; and
 - 4. Public telephone.

Figure 2E-33. Typical General Service Signs (without Exit Numbering)



Figure 2E-34. Typical General Service Signs (with Exit Numbering)



Figure 2E-36. Typical Rest Area Gore Sign

Figure 2E-35. Typical Next Services Sign



B. Food if all of the following are available:

1. Licensing or approval, where required;
2. Continuous operation to serve three meals per day, at least 6 days per week;
3. Public telephone; and
4. Modern sanitary facilities.

C. Lodging if all of the following are available:

1. Licensing or approval, where required;
2. Adequate sleeping accommodations;
3. Public telephone; and
4. Modern sanitary facilities.

D. Public Telephone if continuous operation, 7 days per week is available.

E. Hospital if continuous emergency care capability, with a physician on duty 24 hours per day, 7 days per week is available. A physician on duty would include the following criteria and should be signed in accordance with the priority as follows:

1. Physician on duty within the emergency department;
2. Registered nurse on duty within the emergency department, with a physician in the hospital on call; or
3. Registered nurse on duty within the emergency department, with a physician on call from office or home.

F. Camping if all of the following are available:

1. Licensing or approval, where required;
2. Adequate parking accommodations; and
3. Modern sanitary facilities and drinking water.

Standard:

For any service that is operated on a seasonal basis only, the General Service signs shall be removed or covered during periods when the service is not available.

The General Service signs shall be mounted in an effective location, between the Advance Guide sign and the Exit Direction sign, in advance of the exit leading to the available services.

Guidance:

The General Service sign should contain the interchange number, if any, as illustrated in Figure 2E-34.

Option:

If the distance to the next point where services are available is greater than 16 km (10 miles), a sign NEXT SERVICES XX KM (XX MILES), shown in Figure 2E-35, may be used as a separate panel installed below the Exit Direction sign.

Standard:

Signs for services shall conform to the format for General Service signs (see Section 2D.44) and as specified herein. Letter and numeral sizes shall be as shown in Tables 2E-1 through 2E-4. No more than six general road user services shall be displayed on one sign, which includes any appended panels. General Service signs shall carry the legends for one or more of the following services: Food, Gas, Lodging, Camping, Phone, Hospital, or Tourist Information.

The qualified services available shall be shown at specific locations on the sign.

The sign space normally reserved for a given service symbol or word shall be left blank when that service is not present to provide flexibility for the future when the service might become available.

Guidance:

The standard display of word messages should be FOOD and PHONE in that order on the top line, and GAS and LODGING on the second line. If used, HOSPITAL and CAMPING should be on separate lines (see Figure 2E-34).

Option:

Signing for DIESEL, LP-Gas, or other alternative fuel services may be substituted for any of the general services or appended to such signs. The International Symbol of Accessibility for the Handicapped (D9-5) sign may be used for facilities that qualify.

Guidance:

When symbols are used for the road user services, they should be displayed as follows:

A. Six services:

1. Top row - GAS, FOOD, and LODGING
2. Bottom row - PHONE, HOSPITAL, and CAMPING

B. Four services:

1. Top row - GAS and FOOD
2. Bottom row - LODGING and PHONE

C. Three services:

1. Top row - GAS, FOOD, and LODGING

Option:

Substitutions of other services for any of the services shown above may be made by placing the substitution in the lower right (four services) or extreme right (three services) portion of the panel. An action message or an interchange number may be used for symbol signs in the same manner as they are used for word message signs. The Diesel Fuel (D9-11) symbol or the LP-Gas (D9-15) symbol may be substituted for the symbol representing fuel or appended to such assemblies. The information (D9-10) symbol may be substituted on any of the above configurations.

At rural interchange areas where limited road user services are available and where it is unlikely that additional services will be provided within the near future, a panel having one to three services (words or symbols) may be appended to ground-mounted interchange guide signs.

Standard:

If more than three services become available at rural interchange areas where limited road user services were anticipated, any appended sign panel shall be removed and replaced with an independently-mounted General Service sign as described in this Section.

Option:

A separate Telephone Service sign (D9-1) may be installed if telephone facilities are located adjacent to the route at places where public telephones would not normally be expected.

The Recreational Vehicle Sanitary Station (D9-12) sign may be used as needed to indicate the availability of facilities designed for dumping wastes from recreational vehicle holding tanks.

In some locations, signs may be used to indicate that services are not available.

A Truck Parking (D9-16) sign may be used on a separate panel below the other general road user services to direct truck drivers to designated parking areas.

Section 2E.52 Rest and Scenic Area Signs

Guidance:

Signing for rest areas and scenic areas should conform to the provisions set forth in Sections 2D.41 and 2D.42. However, the signs should be suitably enlarged for freeway or expressway application. A roadside area that does not contain restroom facilities should be signed to indicate the major road user service that is provided. For example, an area with only parking should be signed PARKING AREA. An area with picnic tables and parking should be signed PICNIC AREA.

Rest areas that have tourist information and welcome centers should be signed as discussed in Section 2E.53.

Scenic area signing should be consistent with that specified for rest areas. Standard messages should read SCENIC AREA, SCENIC VIEW, SCENIC OVERLOOK, or the equivalent.

Standard:

All signs for rest and scenic areas shall have white letters, symbols, and borders on a blue background. Letter and numeral sizes shall conform to the minimum requirements of Tables 2E-1 through 2E-4. On the approach to rest areas, a REST AREA advance guide sign shall be placed 2 km (1 mi) and/or 4 km (2 mi) in advance of the rest area. At the rest area exit gore, there shall be a sign with a message REST AREA together with an arrow indicating the appropriate turn as shown in Figure 2E-36.

Option:

If the rest area has facilities for the physically impaired (see Section 2D.44), the International Symbol of Accessibility for the Handicapped (D9-5) sign may be placed with or beneath the REST AREA advance guide sign.

Between the REST AREA advance guide sign and the gore of the rest area exit, there may be

a sign reading REST AREA. The words NEXT RIGHT or an arrow may be included as part of the message.

To provide the road user with information on the location of succeeding rest areas, a sign with the word message NEXT REST AREA XX KM (XX MILES) may be installed independently or as a supplemental panel mounted below one of the REST AREA advance guide signs.

Section 2E.53 Tourist Information and Welcome Centers

Support:

Tourist information and welcome centers have been constructed within rest areas on freeways and expressways and are operated by either a State or a private organization. Others have been located within close proximity to these facilities and operated by civic clubs, chambers of commerce, or private enterprise.

Guidance:

An excessive number of supplemental panels should not be installed with Tourist Information or Welcome Center signs so as not to overload the road user.

Standard:

Tourist Information or Welcome Center signs shall have a white legend and border on a blue background. Continuously-staffed or unstaffed operation at least 8 hours per day, 7 days per week shall be required.

If operated only on a seasonal basis, the Tourist Information or Welcome Center signs shall be removed or covered during the off seasons.

Guidance:

For freeway or expressway rest area locations that also serve as tourist information or welcome centers, the following signing criteria should be used:

- A. The locations for the Advance Guide, Exit Direction, and Exit Gore signs should meet the General Service signing requirements described in Section 2E.51.
- B. If the signing for the tourist information or welcome center is to be accomplished in conjunction with the initial signing for the rest areas, the message on the Advance Guide sign should be REST AREA, TOURIST INFO CENTER, XX KM (XX MILES) or REST AREA, WELCOME CENTER XX KM (XX MILES). On the Exit Direction sign the message should be REST AREA, TOURIST INFO CENTER with an upward sloping arrow (or NEXT RIGHT), or

REST AREA, WELCOME CENTER with an upward sloping arrow (or NEXT RIGHT).

- C. If the initial rest area Advance Guide and Exit Direction signing is in place, these signs should include, on supplemental panels, the legend TOURIST INFO CENTER or STATE NAME (optional), WELCOME CENTER.
- D. The Gore sign should contain only the legend REST AREA with the arrow, and should not be supplemented with any legend pertaining to the tourist information center or welcome center.

Option:

An alternative to the supplemental TOURIST INFO CENTER legend is the Information Symbol (D9-10) sign, which may be appended beneath the REST AREA advance guide sign. The name of the State or local jurisdiction may appear on tourist information/welcome center signs if the jurisdiction controls the operation of the tourist information or welcome center and the center meets the operating criteria set forth herein and is consistent with State policies. The State name may be used on the Advance Guide and the Exit Direction signs.

Guidance:

For tourist information centers located off the freeway or expressway facility, additional signing criteria should be as follows:

- A. Each state should adopt a policy establishing the maximum distance that a tourist information center can be located from the interchange in order to be included on official signs.
- B. The location of signing should be in accordance with requirements pertaining to General Service signing (see Section 2E.51).
- C. Signing along the crossroad should be installed to guide the road user from the interchange to the tourist information center and back to the interchange.

Option:

As an alternative, the Information Symbol (D9-10) sign may be appended to the guide signs for the exit providing access to the tourist information center. As a second alternative, the Information Symbol sign may be combined with General Service signing.

Section 2E.54 Reference Posts**Standard:**

Reference posts shall be placed on all freeway facilities. Reference posts shall also be placed on expressway facilities that are located on a route where there is reference post continuity. Reference posts shall conform to the general provisions for reference posts contained in Section 2D.45. These signs shall contain 250 mm (10 in) white numerals on 300 mm (12 in) wide vertical green panels with a white border. Panels shall be 600, 900, or 1200 mm (24, 36, or 48 in) in length for one, two, or three digits, respectively, and shall contain the abbreviation KM (MILE).

Reference posts located in line with delineator posts shall have the bottom of the sign at the same height as the delineator.

The distance numbering shall be continuous for each route within any State except where overlaps occur (see Section 2E.28). With overlapped routes, continuity shall be established for one of the routes. If one of the overlapping routes is an Interstate route, that route shall be selected for continuity of distance numbering.

Guidance:

The route selected for continuity of distance numbering should also have continuity in interchange exit numbering (see Section 2E.28). On a route without reference post continuity, the first marker beyond the overlap should indicate the total distance traveled on the route.

Option:

Reference posts may be placed up to 9 m (30 ft) from the edge of the pavement.

Section 2E.55 Miscellaneous Guide Signs**Support:**

Miscellaneous Guide signs are used to point out geographical features, such as rivers and summits, and other jurisdictional boundaries (see Section 2D.47).

Option:

Miscellaneous Guide signs may be used if they do not interfere with signing for interchanges or other critical points.

Guidance:

Miscellaneous Guide signs should not be installed unless there are specific reasons for orienting the road users or identifying control points for activities that are clearly in the public interest. If Miscellaneous Guide signs are to be of value to the road user, they should be consistent with other freeway or expressway guide signs in design and legibility. On all such signs, the design should be simple and dignified, devoid of any tendency toward flamboyant advertising, and in general conformance with other freeway and expressway signing.

Section 2E.56 Radio Information Signing**Option:**

Radio-Weather Information (D12-1) signs may be used in areas where difficult driving conditions commonly result from weather systems. Radio-Traffic Information signs may be used in conjunction with traffic management systems.

Standard:

Radio-Weather and Radio-Traffic Information signs shall have a white legend and border on a blue background. Only the numerical indication of the radio frequency shall be used to identify a station broadcasting travel-related weather or traffic information. No more than three frequencies shall be shown on each sign. Only radio stations whose signal will be of value to the road user and who agree to broadcast either of the two items below shall be identified on Radio-Weather and Radio-Traffic Information signs:

- A. Periodic weather warnings at no more than 15-minute intervals during periods of adverse weather.**
- B. Driving condition information (affecting the roadway being traveled) at a rate of at least once every 15 minutes, or when required, during periods of adverse traffic conditions, and when supplied by an official agency having jurisdiction.**

If a station to be considered operates only on a seasonal basis, its signs shall be removed or covered during the off season.

Guidance:

The radio station should have a signal strength to adequately broadcast 100 km (70 mi) along the route. Signs should be spaced as needed for each direction of travel at distances determined by an engineering study. The stations to be included on the signs

should be selected in cooperation with the association(s) representing major broadcasting stations in the area to provide: (1) maximum coverage to all road users on both AM and FM frequencies; and (2) consideration of 24 hours per day, 7 days per week broadcast capability.

Option:

In roadway rest area locations, a smaller sign using a greater number of radio frequencies, but of the same general design, may be used.

Standard:

Radio-Weather and Radio-Traffic Information signs installed in rest areas shall be positioned such that they are not visible from the main roadway.

Option:

A Channel 9 Monitored (D12-3) sign or cell phone sign may be installed as needed.

Standard:

Only official public agencies or their designee shall be shown as the monitoring agency on the Channel 9 Monitored sign.

Section 2E.57 Carpool Information Signing

Option:

In areas having carpool matching services, Carpool Information (D12-2) signs may be provided adjacent to highways with preferential lanes or along any other highway.

Guidance:

Because this is an information sign related to road user services, the Carpool Information sign should have a white legend and border on a blue background.

Standard:

If a local transit logo or carpool symbol is incorporated into the Carpool Information sign, the maximum vertical dimension of the logo or symbol shall not exceed 900 mm (36 in).

Section 2E.58 Weigh Station Signing

Standard:

Weigh Station signing on freeways and expressways shall be the same as that specified in Section 2D.43, except for lettering size and the advance posting distance for the Exit Direction sign, which shall be located a minimum of 450 m (1,500 ft) in advance of the gore.

Support:

Weigh Station sign layouts for expressway and freeway applications are shown in the "Standard Highway Signs" book.

CHAPTER 2F. SPECIFIC SERVICE SIGNS

Section 2F.01 Eligibility

Standard:

Specific Service signs shall be defined as guide signs that provide road users with business identification and directional information for services and for eligible attractions.

Guidance:

The use of Specific Service signs should be limited to areas primarily rural in character or to areas where adequate sign spacing can be maintained.

Option:

Where an engineering study determines a need, Specific Service signs may be used on any class of highways.

Guidance:

Specific Service signs should not be installed at an interchange where the road user cannot conveniently re-enter the freeway or expressway and continue in the same direction of travel.

Standard:

Eligible service facilities shall comply with laws concerning the provisions of public accommodations without regard to race, religion, color, age, sex, or national origin, and laws concerning the licensing and approval of service facilities.

The attraction services shall include only facilities which have the primary purpose of providing amusement, historical, cultural, or leisure activities to the public.

Guidance:

Distances to eligible services should not exceed 5 km (3 mi) in either direction.

Option:

If, within the 5 km (3 mi) limit, facilities for the services being considered are not available or choose not to participate in the program, the limit of eligibility may be extended in 5 km (3 mi) increments until one or more facilities for the services being considered chooses to participate, or until 25 km (15 mi) is reached, whichever comes first.

Guidance:

If State or local agencies elect to provide Specific Service signing, there should be a statewide policy for such signing and criteria for the availability of the various types of services. The criteria should consider the following:

- A. To qualify for a GAS logo panel, a business should have:
 - 1. Vehicle services including gas and/or alternative fuels, oil, and water;
 - 2. Modern sanitary facilities and drinking water;
 - 3. Continuous operation at least 16 hours per day, 7 days per week for freeways and expressways, and continuous operation at least 12 hours per day, 7 days per week for conventional roads; and
 - 4. Public telephone.
- B. To qualify for a FOOD logo panel, a business should have:
 - 1. Licensing or approval, where required;
 - 2. Continuous operations to serve three meals per day, at least 6 days per week;
 - 3. Public telephone; and
 - 4. Modern sanitary facilities.
- C. To qualify for a LODGING logo panel, a business should have:
 - 1. Licensing or approval, where required;
 - 2. Adequate sleeping accommodations;
 - 3. Public telephone; and
 - 4. Modern sanitary facilities.
- D. To qualify for a CAMPING logo panel, a business should have:
 - 1. Licensing or approval, where required;
 - 2. Adequate parking accommodations; and
 - 3. Modern sanitary facilities and drinking water.

E. To qualify for an ATTRACTION logo panel, a facility should have:

1. Regional significance; and
2. Adequate parking accommodations.

Section 2F.02 Application

Standard:

The number of Specific Service signs along an approach to an interchange or intersection, regardless of the number of service types displayed, shall be limited to a maximum of four. In the direction of traffic, successive Specific Service signs shall be for attraction, camping, lodging, food, and gas services, in that order.

A Specific Service sign shall display the word message GAS, FOOD, LODGING, CAMPING, or ATTRACTION, an appropriate directional legend such as the word message EXIT XX, NEXT RIGHT, SECOND RIGHT, or directional arrows, and the related logo sign panels. No more than three types of services shall be represented on any sign or sign assembly. If three types of services are shown on one sign, then the logo panels shall be limited to two for each service (for a total of six logo panels). The legend and logo panels applicable to a service type shall be displayed such that the road user will not associate them with another service type on the same sign. No service type shall appear on more than one sign. The signs shall have a blue background, a white border, and white legends of upper-case letters, numbers, and arrows.

Guidance:

The Specific Service signs should be located to take advantage of natural terrain, to have the least impact on the scenic environment, and to avoid visual conflict with other signs within the highway right-of-way.

Option:

GAS, FOOD, LODGING, and CAMPING signs may be used on any class of highway.

General Service signs (see Sections 2D.44 and 2E.51) may be used in conjunction with Specific Service signs for eligible types of services that are not represented by a Specific Service sign.

Support:

Typical Specific Service signs are shown in Figure 2F-1. Typical sign locations are shown in Figure 2F-2.

Figure 2F-1. Typical Specific Service Signs

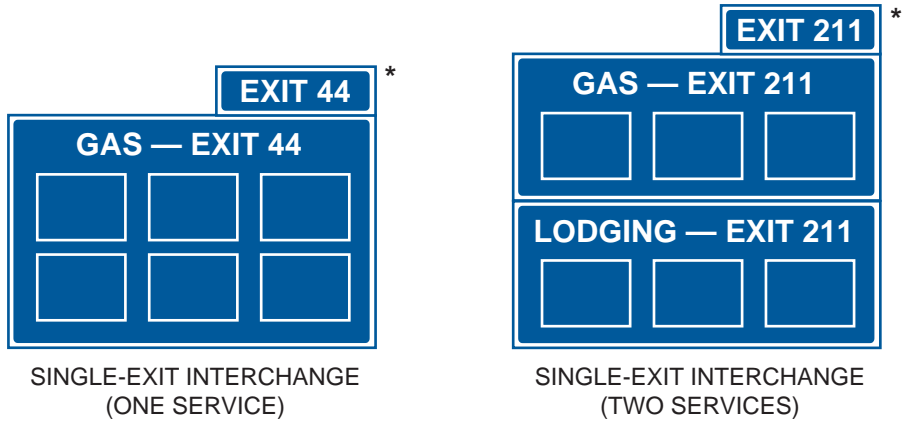

* Exit number option (see Section 2F.07)

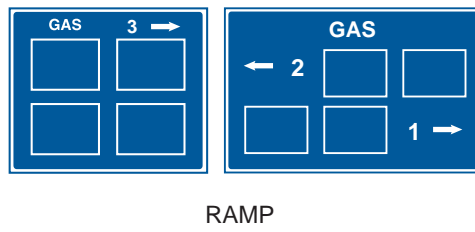
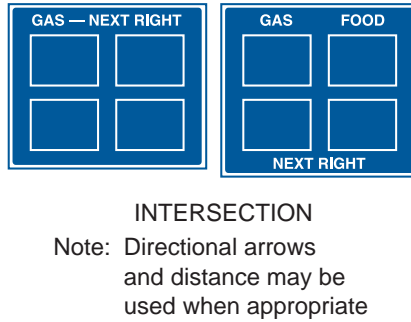
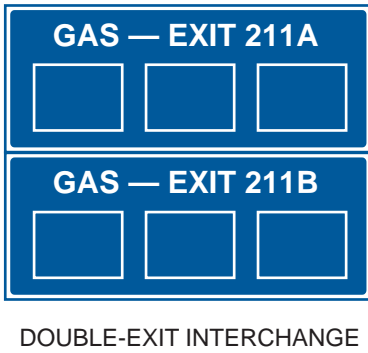
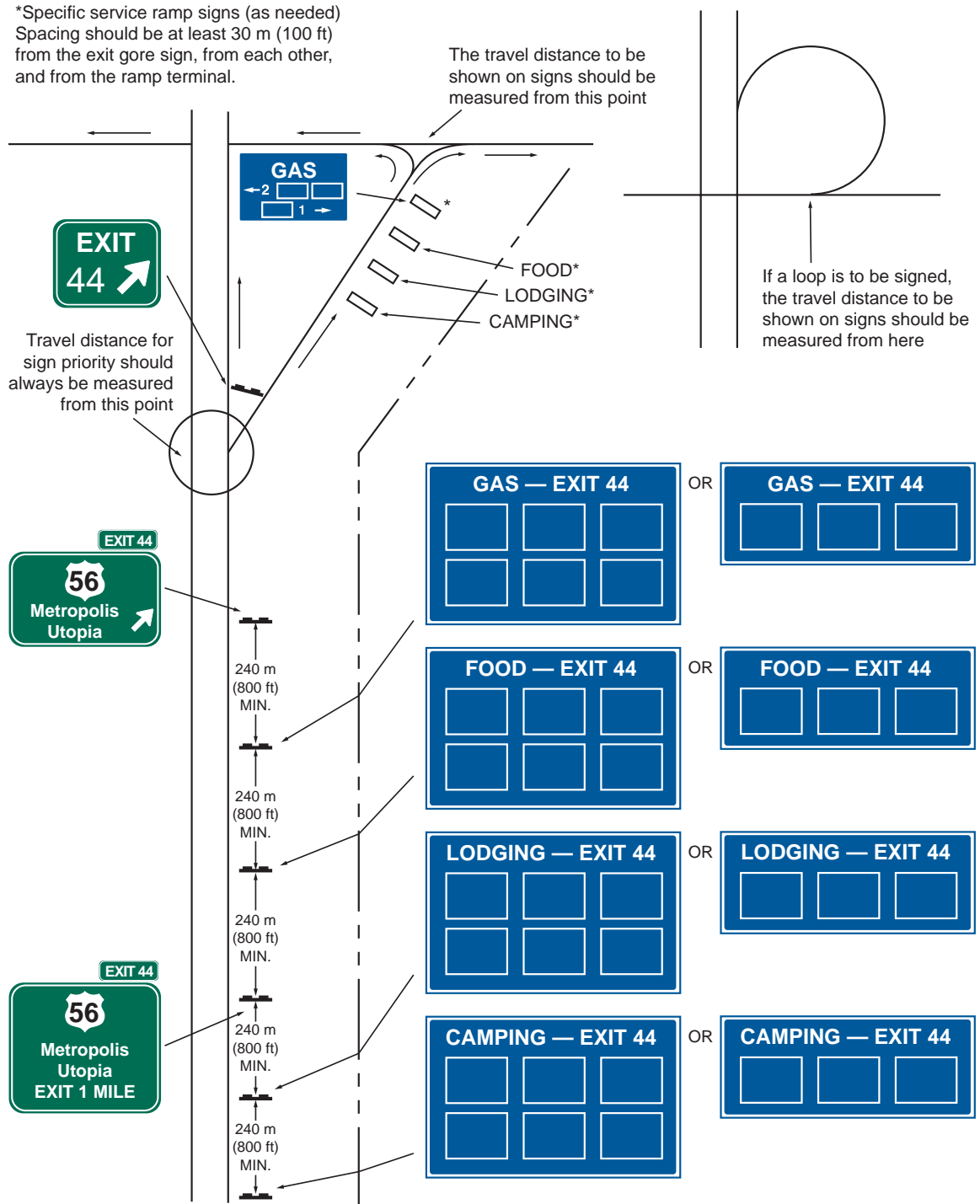

Figure 2F-2. Typical Specific Service Sign Locations



Section 2F.03 Logos and Logo Panels**Standard:**

A logo shall be either an identification symbol/trademark or a word message. Each logo shall be placed on a separate logo panel which shall be attached to the Specific Service sign. Symbols or trademarks used alone for a logo shall be reproduced in the colors and general shape consistent with customary use, and any integral legend shall be in proportionate size. A logo that resembles an official traffic control device shall not be used.

Guidance:

A word message logo, not using a symbol or trademark, should have a blue background with white legend and border.

Option:

Where business identification symbols or trademarks are used alone for a logo, the border may be omitted from the logo panel.

A portion at the bottom of a GAS logo panel may be used to display the legends for alternative fuels (see Section 2E.51) available at the facility. A portion at the bottom of a FOOD logo panel may be used to display the word CLOSED and the day of the week when the facility is closed.

Section 2F.04 Number and Size of Logos and Signs**Guidance:**

Sign sizes should be determined by the amount and height of legend and the number and size of logo panels attached to the sign. All logo panels on a sign should be the same size.

Standard:

Each Specific Service sign or sign assembly shall be limited to no more than six logo panels. There shall be no more than four logo panels for one of the two service types on the same sign or sign assembly.

Support:

Section 2F.08 contains information regarding Specific Service signs for double-exit interchanges.

Standard:

Each logo panel attached to a Specific Service sign shall have a rectangular shape with a width longer than the height. A logo panel on signs for freeways and expressways shall not exceed 1500 mm (60 in) in width and 900 mm (36 in) in height. A logo panel on signs for conventional roads and ramps shall not exceed 600 mm (24 in) in width and 450 mm (18 in) in height. The vertical and horizontal spacing between logo panels shall not exceed 200 mm (8 in) and 300 mm (12 in), respectively.

Support:

Sections 2A.15, 2E.14, and 2E.15 contain information regarding borders, interline spacing, and edge spacing.

Section 2F.05 Size of Lettering**Standard:**

All letters and numerals on Specific Service signs, except on the logo panels, shall be a minimum height of 250 mm (10 in) for signs on freeways and expressways, and 150 mm (6 in) for signs on conventional roads and ramps.

Guidance:

Any legend on a symbol/trademark should be proportional to the size of the symbol/trademark.

Section 2F.06 Signs at Interchanges**Standard:**

The Specific Service signs shall be installed between the previous interchange and at least 240 m (800 ft) in advance of the Exit Direction sign at the interchange from which the services are available (see Figure 2F-2).

Guidance:

There should be at least a 240 m (800 ft) spacing between the Specific Service signs, except for Specific Service ramp signs. However, excessive spacing is not desirable. Specific Service ramp signs should be spaced at least 30 m (100 ft) from the exit gore sign, from each other, and from the ramp terminal.

Section 2F.07 Single-Exit Interchanges

Standard:

At single-exit interchanges, the name of the service type followed by the exit number shall be displayed on one line above the logo panels. At unnumbered interchanges, the directional legend NEXT RIGHT (LEFT) shall be used.

At single-exit interchanges, Specific Service ramp signs shall be installed along the ramp or at the ramp terminal for facilities that have logo panels displayed along the main roadway if the facilities are not readily visible from the ramp terminal. Directions to the service facilities shall be indicated by arrows on the ramp signs. Logo panels on Specific Service ramp signs shall be duplicates of those displayed on the Specific Service signs located in advance of the interchange, but shall be reduced in size.

Guidance:

Specific Service ramp signs should include distances to the service facilities.

Option:

An exit number plaque (see Section 2E.28) may be used instead of the exit number on the signs located in advance of an interchange.

The reduced size logo panels and signs also may be installed along the crossroad.

Section 2F.08 Double-Exit Interchanges

Guidance:

At double-exit interchanges, the Specific Service signs should consist of two sections, one for each exit (see Figure 2F-1).

Standard:

At a double-exit interchange, the top section shall display the logo panels for the first exit and the bottom section shall display the logo panels for the second exit. The name of the service type and the exit number shall be displayed above the logo panels in each section. At unnumbered interchanges, the word message NEXT RIGHT (LEFT) and SECOND RIGHT (LEFT) shall be used in place of the exit number. The number of logo panels on the sign (total of both sections) or the sign assembly shall be limited to six.

Option:

At a double-exit interchange, where a service is to be signed for only one exit, one section of the Specific Service sign may be omitted, or a single exit interchange sign may be used. Signs on ramps and crossroads as described in Section 2F.07 may be used at a double-exit interchange.

Section 2F.09 Signs at Intersections**Standard:**

Where both tourist-oriented information (Chapter 2G) and specific service information would be needed at the same intersection, the design of the tourist-oriented directional signs shall be used, and the needed specific service information shall be incorporated.

Guidance:

If Specific Service signs are used on conventional roads or at intersections on expressways, they should be installed between the previous interchange or intersection and at least 90 m (300 ft) in advance of the intersection from which the services are available.

The spacing between signs should be determined on the basis of an engineering study.

Logo panels should not be displayed for a type of service for which a qualified facility is readily visible.

Standard:

If Specific Service signs are used on conventional roads or at intersections on expressways, the name of each type of service shall be displayed above its logo panel(s), together with an appropriate legend such as NEXT RIGHT (LEFT) or a directional arrow on the same line.

Option:

If Specific Service signs are used on conventional roads or at intersections on expressways, the NEXT RIGHT (LEFT) or other applicable directional legend or action message may be displayed below instead of above the logo panels.

Signs similar to Specific Service ramp signs as described in Section 2F.07 may be provided on the crossroad.

Section 2F.10 Signing Policy**Guidance:**

Each highway agency that elects to use Specific Service signs should establish a signing policy that includes as a minimum, the guidelines of Section 2F.01 and at least the following criteria:

- A. Selection of eligible businesses.
- B. Distances to eligible services.
- C. The use of logo panels, legends, and signs conforming with this Manual and State design requirements.
- D. Removal or covering of logo panels during off seasons for business that operate on a seasonal basis.
- E. The circumstances, if any, under which Specific Service signs may be used in non-rural areas.
- F. Determination of the costs to businesses for initial permits, installations, annual maintenance, and removal of logo panels.

CHAPTER 2G. TOURIST-ORIENTED DIRECTIONAL SIGNS

Section 2G.01 Purpose and Application

Support:

Tourist-oriented directional signs are guide signs with one or more panels that display the business identification of and directional information for business, service, and activity facilities.

Standard:

A facility shall be eligible for tourist-oriented directional signs only if it derives its major portion of income or visitors during the normal business season from road users not residing in the area of the facility.

Option:

Tourist-oriented directional signs may include businesses involved with seasonal agricultural products.

Standard:

When used, tourist-oriented directional signs shall be used only on rural conventional roads and shall not be used at interchanges on expressways or freeways.

Guidance:

Where both tourist-oriented directional signs and Specific Service signs (Chapter 2F) would be needed at the same intersection, the tourist-oriented directional signs should incorporate the needed information from, and be used in place of, the Specific Service signs.

Each State that elects to use tourist-oriented directional signs should have a State policy for use as indicated in Section 2G.07.

Option:

Tourist-oriented directional signs may be used in conjunction with General Service signs (see Section 2D.44).

Section 2G.02 Design**Standard:**

Tourist-oriented directional signs shall have one or more panels for the purpose of displaying the business identification of and directional information for eligible facilities. Each panel shall be rectangular in shape and shall have a white legend and border on a blue background.

The content of the legend on each panel shall be limited to the business identification and directional information for not more than one eligible business, service, or activity facility. The legends shall not include promotional advertising.

Guidance:

Each panel should have a maximum of two lines of legend including not more than one symbol, a separate directional arrow, and the distance to the facility shown beneath the arrow. Arrows pointing to the left or up should be at the extreme left of the sign. Arrows pointing to the right should be at the extreme right of the sign. Symbols, when used, should be to the left of the word legend or logo.

Option:

The tourist-oriented directional sign may have the word message TOURIST ACTIVITIES at the top of the sign.

Standard:

The TOURIST ACTIVITIES word message shall be a white legend and border on a blue background. It shall be placed above and in addition to the panels.

Option:

The General Service sign symbols (see Section 2D.44) and the symbols for recreational and cultural interest area signs (see Chapter 2H) may be used.

Logos for specific businesses, services, and activities may also be used. Based on engineering judgment, the hours of operation may be added on the panels.

Standard:

When used, symbols and logos shall be an appropriate size (see Section 2G.04). Logos resembling official traffic control devices shall not be permitted.

Support:

Typical tourist-oriented directional signs are shown in Figure 2G-1.

Section 2G.03 Style and Size of Lettering

Guidance:

All letters and numbers on tourist-oriented directional signs, except on the logos, should be upper-case and at least 150 mm (6 in) in height. Any legend on a logo should be proportional to the size of the logo.

Standard:

Design standards for upper-case letters, lower-case letters, numerals, and spacing shall be as provided in the "Standard Alphabets for Highway Signs and Pavement Markings."

Section 2G.04 Arrangement and Size of Signs

Standard:

The size of a tourist-oriented directional sign shall be limited to a maximum height of 1.8 m (6 ft). However, additional height shall be allowed to accommodate the addition of the optional TOURIST ACTIVITIES message discussed in Section 2G.02 and the directional word messages discussed in Section 2G.05.

Guidance:

The number of intersection approach signs (one sign for tourist-oriented destinations to the left, one for destinations to the right, and one for destinations straight ahead) installed in advance of an intersection should not exceed three. The number of panels installed on each sign should not exceed four. The panels for right-turn, left-turn, and straight-ahead destinations should be on separate signs. The left-turn destination sign should be located farthest from the intersection, then the right-turn destination sign, with the straight-ahead destination sign located closest to the intersection (see Figure 2G-2). Signs for facilities in the straight-ahead direction should be considered only when there are signs for facilities in either the left or right direction.

When it is appropriate to combine the left-turn and right-turn destination panels on a single sign, the left-turn destination panels should be above the right-turn destination panels (see Figure 2G-1). When there are multiple destinations in the same direction, they should be in order based on their distance from the intersection. Except as noted in

Figure 2G-1. Typical Tourist-Oriented Directional Signs

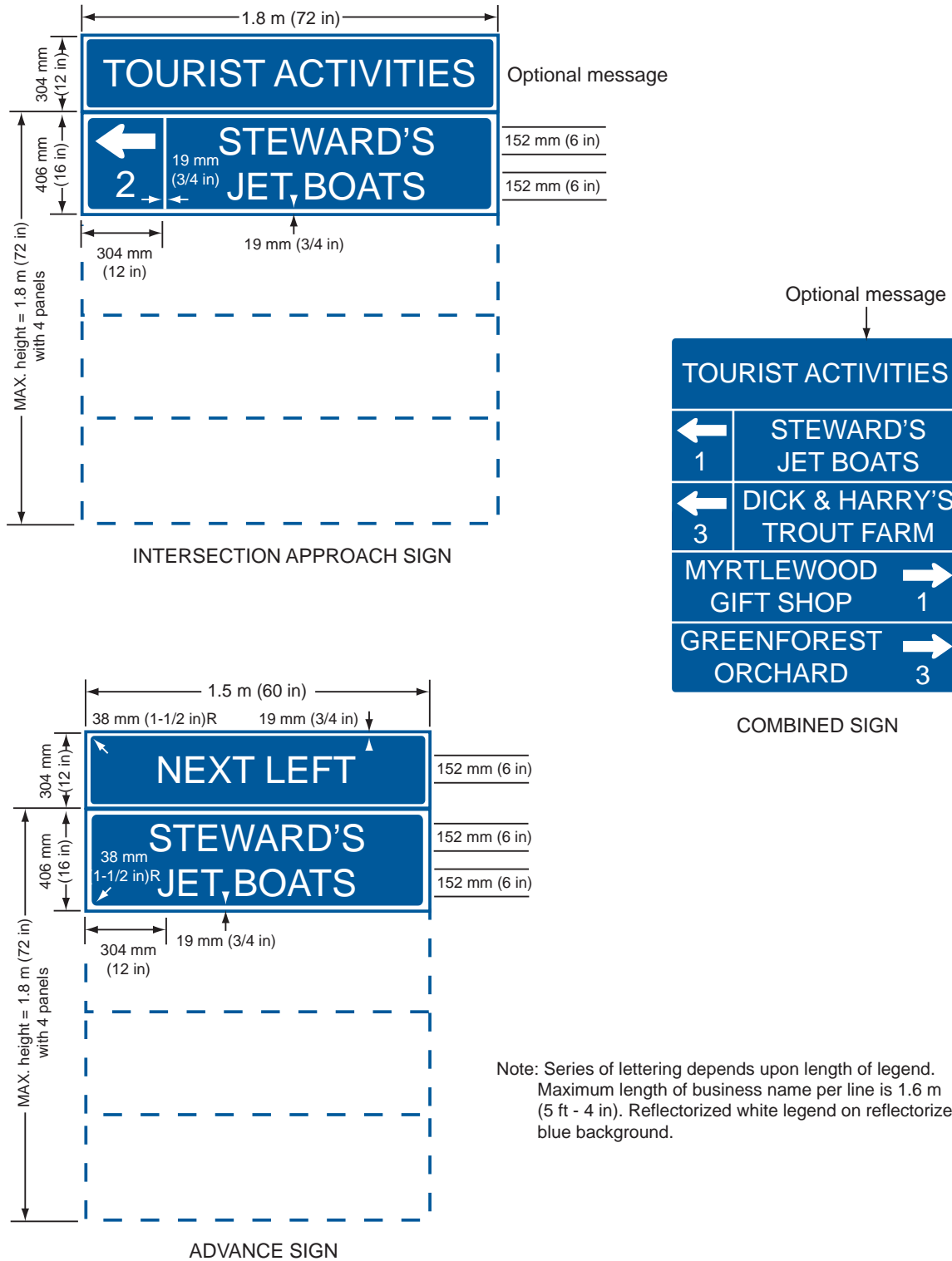

Note: Series of lettering depends upon length of legend.
 Maximum length of business name per line is 1.6 m (5 ft - 4 in). ReflectORIZED white legend on reflectORIZED blue background.

Figure 2G-2. Typical Intersection Approach Signs and Advance Signs for Tourist-Oriented Directional Signs

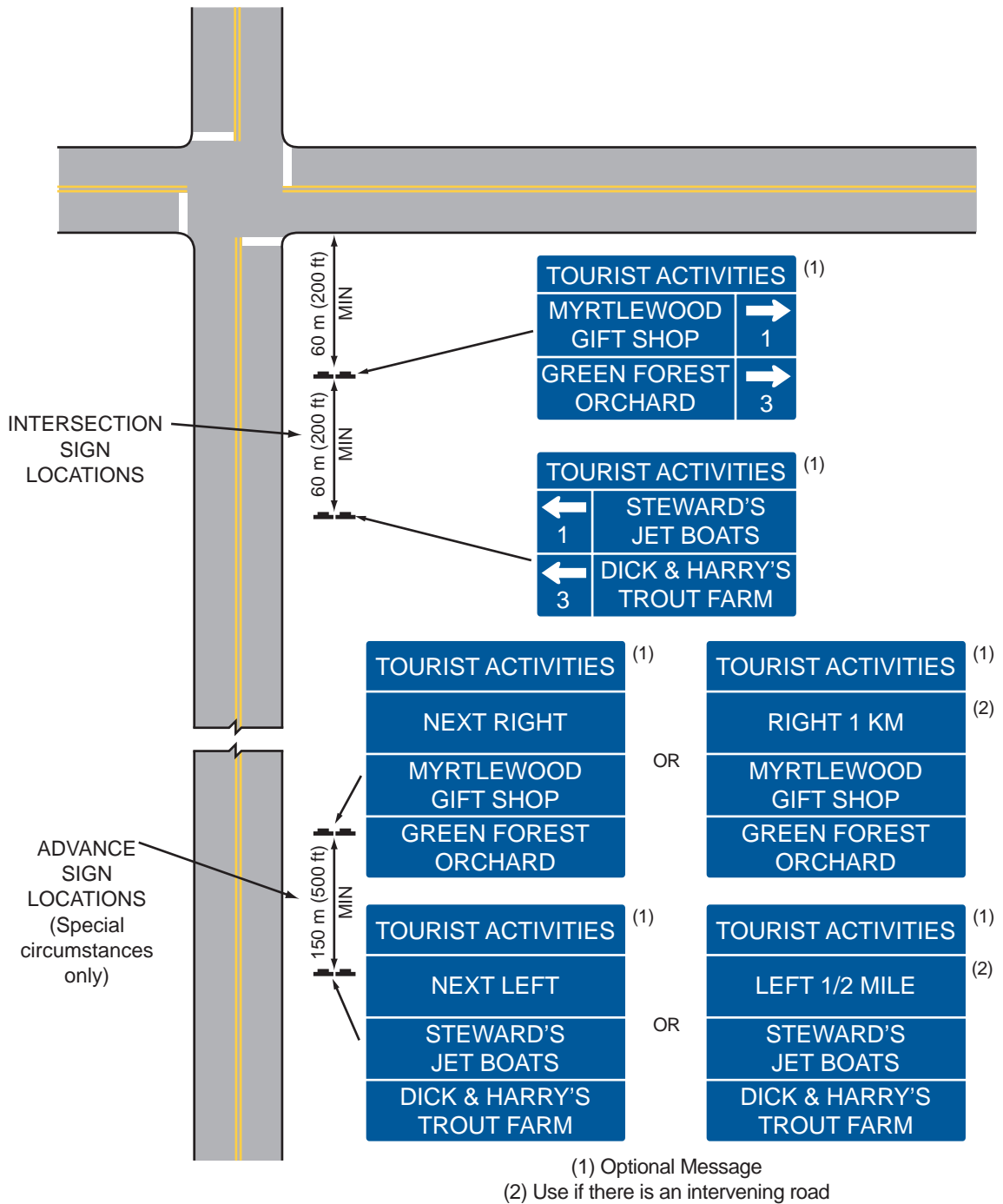

the Option, a straight-ahead panel should not be combined with a sign displaying left- and/or right-turn facilities.

The panels should not exceed the size necessary to accommodate two lines of legend without crowding. Symbols and logos on a panel should not exceed the height of two lines of word legends. All panels and other parts of the sign should be the same width, which should not exceed 1.8 m (6 ft).

Option:

At intersection approaches where three or fewer facilities are shown, the left-turn, right-turn, and straight-ahead destination panels may be combined on the same sign.

Section 2G.05 Advance Signs

Guidance:

Advance signs should be limited to those situations where sight distance, intersection vehicle maneuvers, or other vehicle operating characteristics require advance notification of the services.

The design of the advance sign should be identical to the design of the intersection approach sign. However, the directional arrows and distances to the facilities should be omitted. The directional word messages NEXT RIGHT, NEXT LEFT, or AHEAD should be placed on the sign above the business identification panels. The directional word messages should have the same letter height as the other word messages on the panels (see Figures 2G-1 and 2G-2).

Standard:

The directional word messages shall be a white legend and border on a blue background.

Option:

The legend RIGHT 1 KM (1/2 MILE) or LEFT 1 KM (1/2 MILE) may be used on advance signs when there are intervening minor roads.

The height required to add the directional word messages recommended for the advance sign may be added to the maximum sign height of 1.8 m (6 ft).

Section 2G.06 Sign Locations**Guidance:**

If used, the intersection approach signs should be located at least 60 m (200 ft) in advance of the intersection. Signs should be spaced at least 60 m (200 ft) apart and at least 60 m (200 ft) from other traffic control devices.

If used, advance signs should be located approximately 1 km (0.5 mi) from the intersection with 150 m (500 ft) between these signs. In the direction of travel, the order of advance sign placement should be to show the facilities to the left first, then facilities to the right, and lastly the facilities straight ahead.

Position, height, and lateral clearance of signs should be governed by Chapters 2A and 2D except as permitted in this Section.

Option:

Tourist-oriented directional signs may be placed further from the edge of the road than other traffic control signs.

Standard:

The location of other traffic control devices shall take precedence over the location of tourist-oriented directional signs.

Section 2G.07 State Policy**Standard:**

To be eligible for tourist-oriented directional signing, facilities shall comply with applicable State or Federal laws concerning the provisions of public accommodations without regard to race, religion, color, age, sex, or national origin, and laws concerning the licensing and approval of service facilities. Each State that elects to use tourist-oriented directional signs shall adopt a policy that complies with these provisions.

Guidance:

Each State that elects to use tourist-oriented directional signs should have a policy that includes:

- A. A definition of tourist-oriented business, service, and activity facilities.

- B. Eligibility criteria for signs for facilities.
- C. Provision for incorporating Specific Service signs into the tourist-oriented directional signs as required.
- D. Provision for covering signs during off seasons for facilities operated on a seasonal basis.
- E. Provisions for signs to facilities that are not located on the crossroad when such facilities are eligible for signs.
- F. A definition of the immediate area. The major portion of income or visitors to the facility should come from road users not residing in the immediate area of the facility.
- G. Maximum distances to eligible facilities. The maximum distance should be 8 km (5 mi).
- H. Provision for information centers (plazas) when the number of eligible sign applicants exceeds the maximum permissible number of sign panel installations.
- I. Provision for limiting the number of signs when there are more applicants than the maximum number of signs permitted.
- J. Criteria for use at intersections on expressways.
- K. Provisions for controlling or excluding those businesses which have illegal signs as defined by the Highway Beautification Act of 1965 (23 U.S.C. 131).
- L. Provisions for States to charge fees to cover the cost of signs through a permit system.
- M. A definition of the conditions under which the time of operation is shown.
- N. Provisions for determining if advance signs will be permitted, and the circumstances under which they will be installed.

CHAPTER 2H. RECREATIONAL AND CULTURAL INTEREST AREA SIGNS

Section 2H.01 Scope

Support:

Recreational or cultural interest areas are attractions or traffic generators that are open to the general public for the purpose of play, amusement, or relaxation. Recreational attractions include such facilities as parks, campgrounds, gaming facilities, and ski areas, while examples of cultural attractions include museums, art galleries, and historical buildings or sites.

The purpose of recreation and cultural interest area signs is to guide road users to a general area and then to specific facilities or activities within the area.

Option:

Recreational and cultural interest area signs that depict significant traffic generators may be used on expressway and freeways where there is direct access to these areas as discussed in Section 2H.09.

Recreational and cultural interest area signs may be used off the road network, as appropriate.

Section 2H.02 Application of Recreational and Cultural Interest Area Signs

Support:

Standards for signing recreational or cultural interest areas are subdivided into two different types of signs: (1) symbol signs and (2) destination guide signs.

Guidance:

When highway agencies decide to provide recreational and cultural interest area signing, these agencies should have a policy for such signing. The policy should establish signing criteria for the eligibility of the various types of services, accommodations, and facilities. These signs should not be used where they might be confused with other traffic control signs.

Option:

Recreational and cultural interest area signs may be used on any road to direct persons to facilities, structures, and places, and to identify various services available to the general public. These signs may also be used in recreational or cultural interest areas for signing non-vehicular events and amenities such as trails, structures, and facilities.

Section 2H.03 Regulatory and Warning Signs**Standard:**

All regulatory and warning signs installed on public roads and streets within recreational and cultural interest areas shall conform to the requirements of Chapters 2A, 2B, and 2C.

Section 2H.04 General Design Requirements for Recreational and Cultural Interest Area Symbol Signs**Standard:**

Recreational and cultural interest area symbol signs shall be square or rectangular in shape and shall have a white symbol or message and white border on a brown background. The symbols shall be grouped into the following usage and series categories (see the "Standard Highway Signs" book for design details):

- A. General Information (RG Series)
- B. Motorist Services (RM Series)
- C. Accommodation Services (RA Series)
- D. Land Recreation (RL series)
- E. Water Recreation (RW Series), and
- F. Winter Recreation (RS Series)

Support:

Table 2H-1 contains a listing of the symbols within each series category. Drawings for these symbols are found in the "Standard Highway Signs" book.

Option:

Mirror images of symbols may be used where the reverse image will better convey the message.

Section 2H.05 Symbol Sign Sizes

Guidance:

Recreational and cultural interest area symbol signs should be 600 x 600 mm (24 x 24 in). Where greater visibility or emphasis is needed, larger sizes should be used. Symbol sign enlargements should be in 150 mm (6 in) increments.

Recreational and cultural interest area symbol signs should be 750 x 750 mm (30 x 30 in) when used on expressways or freeways.

Option:

A smaller size of 450 x 450 mm (18 x 18 in) may be used on low-speed, low-volume roadways and on non-road applications.

Section 2H.06 Use of Educational Plaques

Guidance:

Educational plaques should accompany all initial installations of recreational and cultural interest area symbol signs. The educational plaque should remain in place for at least 3 years after the initial installation. If used, the educational plaque should be the same width as the symbol sign.

Option:

Symbol signs that are readily recognizable by the public may be installed without educational plaques.

Support:

Figure 2H-1 illustrates some typical uses of educational plaques.

Section 2H.07 Use of Prohibitive Slash

Standard:

The red diagonal slash, if used on a recreational and cultural interest area sign, shall be placed from the upper left corner to the lower right corner of the sign face. Requirements for retroreflection of the red slash shall be the same as those requirements for legends, symbols, and borders.

Figure 2H-1. Typical Use of Educational Plaques, Prohibitory Slashes, and Arrows



a) Directional sign with arrow

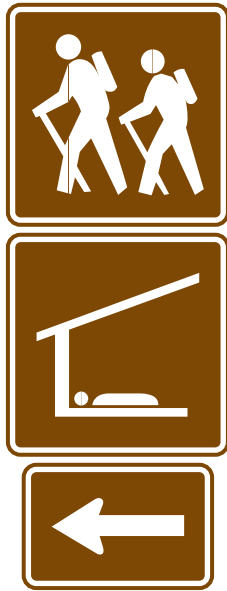

b) Directional signs with arrow

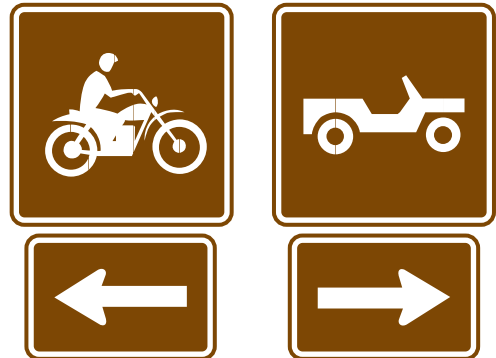

c) Directional signs with arrows

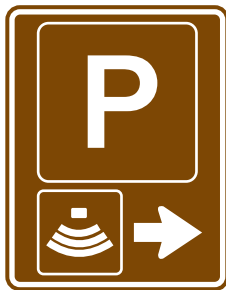

d) Directional sign with secondary symbol



e) Management symbols with prohibitive slashes and educational plaques



f) Directional sign with educational plaque and arrow

Option:

Where it is necessary to indicate a restriction within a recreational or cultural interest area, a red diagonal slash may be used to indicate that the activity is prohibited.

Support:

Figure 2H-1 illustrates some typical uses of prohibitive slashes.

Section 2H.08 Placement of Recreational and Cultural Interest Area Symbol Signs**Standard:**

If used, recreational and cultural interest area symbol signs shall be placed in accordance with the general requirements contained in Chapter 2A. The symbol(s) shall be placed in the uppermost part of the sign assembly and the directional information shall be placed below the symbol(s).

Where the name of the recreational or cultural interest area facility or activity is shown on a general directional guide sign and a symbol is used, the symbol shall be placed below the name (see Figure 2H-2).

Recreational and cultural interest area symbols installed for non-road use shall be placed in accordance with the general sign position requirements of the authority having jurisdiction.

Support:

Figure 2H-3 illustrates typical height and lateral mounting positions. Figure 2H-4 illustrates typical placement of symbol signs within a recreational or cultural interest area. Figures 2H-5 and 2H-6 illustrate some of the symbols that can be used.

Guidance:

The number of symbols used in a single sign assembly should not exceed four.

Option:

Symbols for recreational or cultural interest areas may be used as legend components for a directional sign assembly. The symbols may be used singularly, or in groups of two, three, or four on a single sign assembly (see Figures 2H-1, 2H-3, and 2H-4). Smaller-size secondary symbols (see Figure 2H-1) may be placed beneath the primary symbols, where needed.

Figure 2H-2. Typical General Directional Guide Signs for Conventional Roads



Figure 2H-3. Height and Lateral Position of Signs Located Within Recreational and Cultural Interest Areas

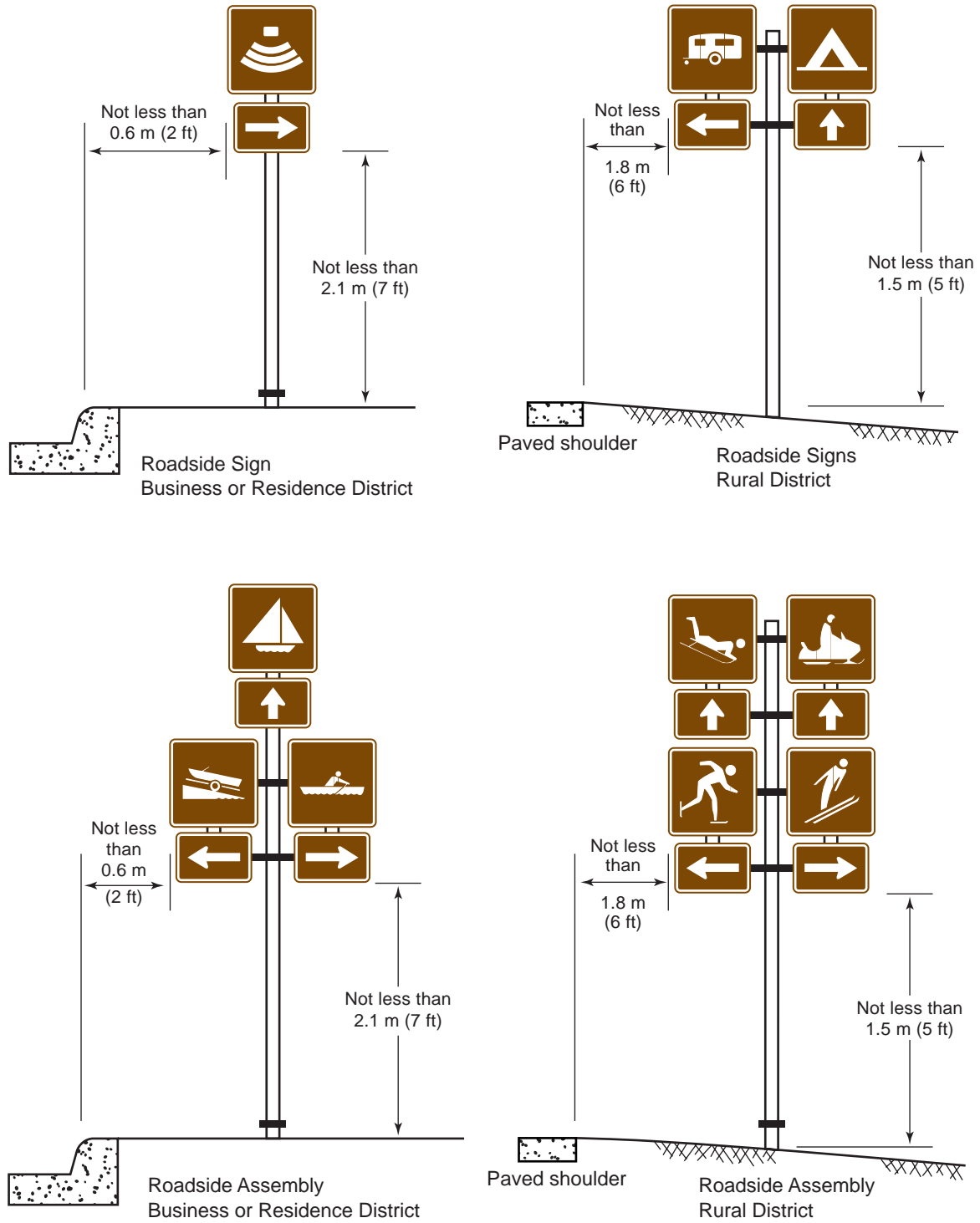

Figure 2H-4. Typical Symbol Signing Layout

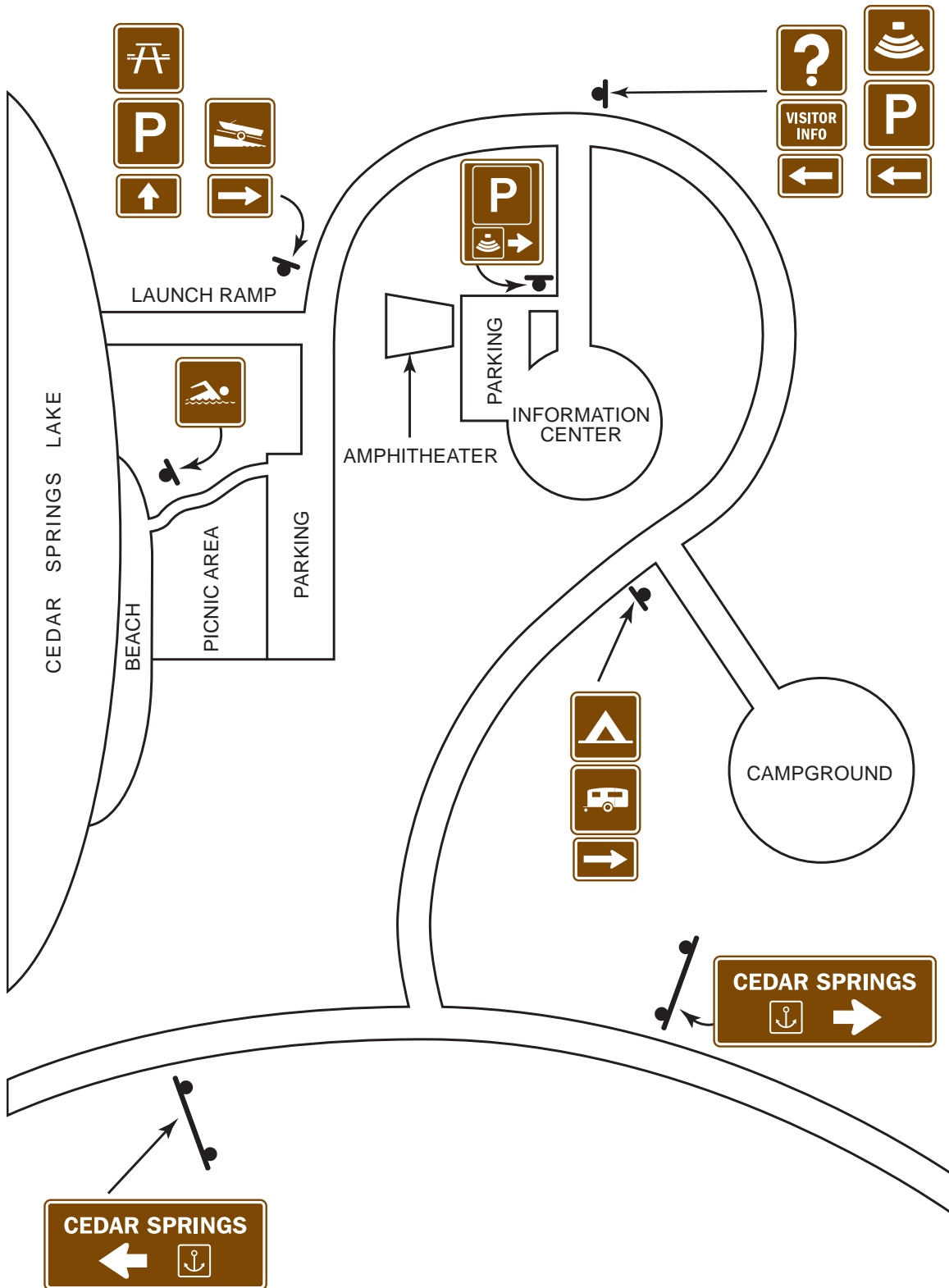
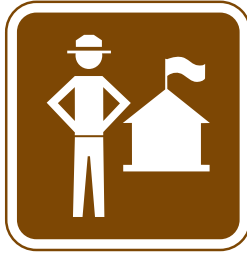

Figure 2H-5. Modifications to Existing Symbols



RG-130
Litter Container



RG-170
Ranger Station

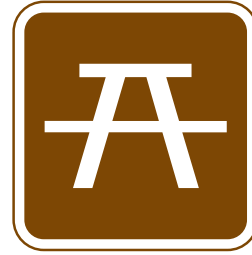

RM-120
Picnic Area



RA-060
Laundry



RA-110
Sleeping Shelter



RL-130
Interpretive Trail
(recommended for use
with educational plaque)

Figure 2H-6. New Recreation & Cultural Interest Area Symbols



Section 2H.09 Destination Guide Signs**Guidance:**

When recreational or cultural interest area destinations are shown on supplemental guide signs, the sign should be rectangular or trapezoidal in shape. The order of preference for use of shapes and colors should be as follows: (1) rectangular with a white legend and border on a green background; (2) rectangular with a white legend and border on a brown background; or (3) trapezoidal with a white legend and border on a brown background.

Standard:

Whenever the trapezoidal shape is used, the color combination shall be a white legend and border on a brown background.

Option:

White-on-brown destination guide signs may be posted at the first point where an access or crossroad intersects a highway where recreational or cultural interest areas are a significant destination along conventional roads, expressways, or freeways. White-on-brown supplemental guide signs may be used along conventional roads, expressways, or freeways to direct road users to recreational or cultural interest areas. Where access or crossroads lead exclusively to the recreational or cultural interest area, the advance guide sign and the exit direction sign may be white-on-brown.

Standard:

Linear parkway-type highways that merely function as arterial connectors without providing access to recreational or cultural interest areas shall not qualify for the use of white-on-brown destination guide signs. Directional guide signs used on these highways shall conform to Chapter 2D.

All gore signs shall have a white legend and border on a green background. The background color of the interchange exit number panel shall match the background color of the guide sign. Design characteristics of conventional road, expressway, or freeway guide signs shall conform to Chapter 2D or 2E except as specified in this Section for color combination.

The advance guide sign and the Exit Direction sign shall retain the white-on-green color combination where the crossroad leads to a destination other than a recreational or cultural interest area.

Support:

Figure 2H-2 illustrates destination guide signs commonly used for identifying recreational or cultural interest areas or facilities.

CHAPTER 2I. EMERGENCY MANAGEMENT SIGNING

Section 2I.01 Emergency Management

Guidance:

Contingency planning for an emergency evacuation should be considered by all State and local jurisdictions and should consider the use of all applicable roadways.

In the event of a disaster where highways that cannot be used will be closed, a successful contingency plan should account for the following elements: a controlled operation of certain designated highways, the establishment of traffic operations for the expediting of essential traffic, and the provision of emergency centers for civilian aid.

Section 2I.02 Design of Emergency Management Signs

Standard:

Emergency Management signs shall be used to guide and control highway traffic during an emergency.

Emergency Management signs shall not permanently displace any of the standard signs that are normally applicable.

Advance planning for transportation operations' emergencies shall be the responsibility of State and local authorities. The Federal Government shall provide guidance to the States as necessitated by changing circumstances.

Guidance:

As conditions permit, the Emergency Management signs should be replaced or augmented by standard signs.

The background of Emergency Management signs should be retroreflective.

Because Emergency Management signs might be needed in large numbers for temporary use during an emergency, consideration should be given to their fabrication from any light and economical material that can serve through the emergency period.

Option:

Any Emergency Management sign may be accompanied by a standard triangular plaque for marking areas contaminated by biological and chemical warfare agents and radioactive fallout.

Section 2I.03 EVACUATION ROUTE Sign (EM-1)**Standard:**

The EVACUATION ROUTE (EM-1) sign shall be circular, having a minimum outside diameter of 450 mm (18 in), carrying a directional arrow and the legend EVACUATION ROUTE.

Option:

An approved Emergency Management symbol may appear near the bottom of the sign with a diameter of 87 mm (3.5 in).

Standard:

The legend, arrow, symbol, and border shall be white on a blue background. At least the arrow and border shall be retroreflective. The arrow designs shall include a straight vertical arrow pointing upward, a straight horizontal arrow pointing to the left or right, or a bent arrow pointing to the left or right for advance warning of a turn.

If used, the EVACUATION ROUTE sign, with the appropriate arrow, shall be installed 45 to 90 m (150 to 300 ft) in advance of, and at, any turn in an approved evacuation route. The sign shall also be installed elsewhere for straight-ahead confirmation where needed.

If used in urban areas, the EVACUATION ROUTE sign shall be mounted at the right-hand side of the roadway, not less than 2.1 m (7 ft) above the top of the curb, and at least 0.3 m (1 ft) back from the face of the curb. If used in rural areas, it shall be not less than 2.1 m (7 ft) above the pavement and 1.8 to 3 m (6 to 10 ft) to the right side of the roadway edge.

EVACUATION ROUTE signs shall not be placed where they will conflict with other signs. Where conflict in placement would occur between the EVACUATION ROUTE sign and a standard regulatory sign, the regulatory sign shall take precedence.

Option:

In case of conflict with guide or warning signs, the Emergency Management sign may take precedence.

Guidance:

Placement of EVACUATION ROUTE signs should be made under the supervision of the officials having jurisdiction over the placement of other traffic signs. Coordination



EM-1
900 mm (36 in)
diameter



EM-2
750 x 600 mm
(30 x 24 in)

R1-1



EM-3
750 x 600 mm
(30 x 24 in)



EM-4
650 x 750 mm
(26 x 30 in)



EM-5
650 x 750 mm
(26 x 30 in)

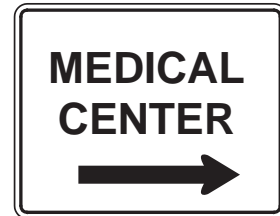

EM-6a
750 x 600 mm
(30 x 24 in)



EM-7b
750 x 600 mm
(30 x 24 in)

with Emergency Management authorities and agreement between contiguous political entities should occur to assure continuity of routes.

Option:

The arrow may be a separate panel attached to the face of the sign.

Section 2I.04 AREA CLOSED Sign (EM-2)

Standard:

The AREA CLOSED (EM-2) sign shall be used to close a roadway in order to prohibit traffic from entering the area. It shall be installed on the shoulder as near as practical to the right edge of the roadway, or preferably, on a portable mounting or barricade partly or entirely in the roadway.

Guidance:

For best visibility, particularly at night, the sign height should not exceed 1.2 m (4 ft) from the pavement to the bottom of the sign. Unless adequate advance warning signs are used, it should not be placed to create a complete and unavoidable blocked route. Where feasible, the sign should be located at an intersection that provides a detour route.

Section 2I.05 TRAFFIC CONTROL POINT Sign (EM-3)

Standard:

The TRAFFIC CONTROL POINT (EM-3) sign shall be used to designate a location where an official traffic control point has been set up to impose such controls as are necessary to limit congestion, expedite emergency traffic, exclude unauthorized vehicles, or protect the public.

The sign shall be installed in the same manner as the AREA CLOSED sign (see Section 2I.04), and at the point where traffic must stop to be checked.

The standard STOP (R1-1) sign shall be used in conjunction with the TRAFFIC CONTROL POINT sign. The TRAFFIC CONTROL POINT sign shall consist of a black legend and border on a retroreflectorized white background.

Guidance:

The TRAFFIC CONTROL POINT sign should be mounted directly below the STOP sign.

Section 2I.06 MAINTAIN TOP SAFE SPEED Sign (EM-4)**Option:**

The MAINTAIN TOP SAFE SPEED (EM-4) sign may be used on highways where conditions are such that it is prudent to evacuate or traverse an area as quickly as possible.

Where an existing Speed Limit (R2-1) sign is in a suitable location, the MAINTAIN TOP SAFE SPEED sign may conveniently be mounted directly over the face of the speed limit sign that it supersedes.

Support:

Since any speed zoning would be impractical under such emergency conditions, no minimum speed limit can be prescribed by the MAINTAIN TOP SAFE SPEED sign in numerical terms. Where traffic is supervised by a traffic control point, official instructions will usually be given verbally, and the sign will serve as an occasional reminder of the urgent need for maintaining the proper safe speed.

Guidance:

The sign should be installed as needed, in the same manner as other standard speed signs.

Standard:

If used in rural areas, the MAINTAIN TOP SAFE SPEED sign shall be mounted on the right side of the road with its lower edge not less than 1.5 m (5 ft) above the pavement, 1.8 to 3 m (6 to 10 ft) from the roadway edge. If used in urban areas, the height shall be not less than 2.1 m (7 ft), and the nearest edge of the sign shall be not less than 0.3 m (1 ft) back from the face of the curb.

Section 2I.07 ROAD (AREA) USE PERMIT REQUIRED FOR THRU TRAFFIC Sign (EM-5)**Support:**

The intent of the ROAD (AREA) USE PERMIT REQUIRED FOR THRU TRAFFIC sign is to notify road users of the presence of the traffic control point so that those who do not have priority permits issued by designated authorities can take another route, or turn back, without making a needless trip and without adding to the screening load at the post. Local traffic, without permits, can proceed as far as the traffic control post.

Standard:

If used, the **ROAD (AREA) USE PERMIT REQUIRED FOR THRU TRAFFIC (EM-5)** sign shall be used at an intersection that is an entrance to a route on which a traffic control point is located.

If used, the sign shall be installed in a manner similar to that of the **MAINTAIN TOP SAFE SPEED** sign (see Section 2I.06).

Section 2I.08 Emergency Aid Center Signs (EM-6 Series)**Standard:**

In the event of emergency, State and local authorities shall establish various centers for civilian relief, communication, medical service, and similar purposes. To guide the public to such centers a series of directional signs shall be used.

Emergency Aid Center (EM-6 series) signs shall carry the designation of the center and an arrow indicating the direction to the center. They shall be installed as needed, at intersections and elsewhere, on the right side of the roadway, at a height in urban areas of at least 2.1 m (7 ft), and not less than 0.3 m (1 ft) back from the face of the curb, and in rural areas at a height of 1.5 m (5 ft), 1.8 to 3 m (6 to 10 ft) from the roadway edge.

Emergency Aid Center signs shall carry one of the following legends, as appropriate, or others designating similar emergency facilities:

- A. **MEDICAL CENTER (EM-6a)**
- B. **WELFARE CENTER (EM-6b)**
- C. **REGISTRATION CENTER (EM-6c)**
- D. **DECONTAMINATION CENTER (EM-6d)**

Section 2I.09 Shelter Directional Signs (EM-7 Series)**Standard:**

Shelter Directional (EM-7 Series) signs shall be used to direct the public to selected shelters that have been licensed and marked for emergency use.

The installation of Shelter Directional signs shall conform to established highway signing standards. Where used, the signs shall not be installed in competition with other necessary highway guide, warning, and regulatory signs.

The Shelter Directional sign shall be a horizontal rectangle, 750 x 600 mm (30 x 24 in). The identifying word and the word SHELTER, the directional arrow, the distance to the shelter, and the border shall be black on a white background.

Option:

The distance to the shelter may be omitted from the sign when appropriate.

Shelter Directional signs may carry one of the following legends, or others designating similar emergency facilities:

- A. EMERGENCY (EM-7a)
- B. HURRICANE (EM-7b)
- C. FALLOUT (EM-7c)
- D. CHEMICAL (EM-7d)

If appropriate, the name of the facility may be used.

The Shelter Directional signs may be installed on the Interstate Highway System or any other major highway system when it has been determined that a need exists for such signs as part of a State or local shelter plan.

The Shelter signs may be used to identify different routes to a shelter to provide for rapid movement of large numbers of persons.

Guidance:

The Shelter Directional sign should be used sparingly and only in conjunction with approved plans of State and local authorities.

As a general rule, the Shelter sign should not be posted more than 8 km (5 mi) from a shelter.



PART 3

Markings

MUTCD 2000

Manual on Uniform Traffic Control Devices

m i l l e n n i u m e d i t i o n

December 2000



U.S. Department
of Transportation

**Federal Highway
Administration**

PART 3. MARKINGS

TABLE OF CONTENTS

	<u>Page</u>
CHAPTER 3A. GENERAL	Dec., 2000
Section 3A.01 Functions and Limitations	3A-1
Section 3A.02 Standardization of Application.....	3A-1
Section 3A.03 Materials	3A-2
Section 3A.04 Colors	3A-2
Section 3A.05 Colors of Longitudinal Pavement Markings	3A-3
Section 3A.06 Widths and Patterns of Longitudinal Pavement Markings	3A-3
CHAPTER 3B. PAVEMENT AND CURB MARKINGS	Dec., 2000
Section 3B.01 Yellow Centerline and Left Edge Line Pavement Markings and Warrants	3B-1
Section 3B.02 No-Passing Zone Pavement Markings and Warrants	3B-6
Section 3B.03 Other Yellow Longitudinal Pavement Markings	3B-11
Section 3B.04 White Lane Line and Right Edge Line Pavement Markings and Warrants	3B-14
Section 3B.05 Other White Longitudinal Pavement Markings	3B-15
Section 3B.06 Edge Line Pavement Markings	3B-19
Section 3B.07 Warrants for Use of Edge Lines	3B-21
Section 3B.08 Extensions Through Intersections or Interchanges	3B-22
Section 3B.09 Lane Reduction Transition Markings	3B-22
Section 3B.10 Approach Markings for Obstructions.....	3B-26
Section 3B.11 Raised Pavement Markers	3B-27
Section 3B.12 Raised Pavement Markers as Vehicle Positioning Guides with Other Longitudinal Markings	3B-29
Section 3B.13 Raised Pavement Markers Supplementing Other Markings	3B-30
Section 3B.14 Raised Pavement Markers Substituting for Pavement Markings.....	3B-31
Section 3B.15 Transverse Markings	3B-32
Section 3B.16 Stop and Yield Lines.....	3B-32
Section 3B.17 Crosswalk Markings	3B-34
Section 3B.18 Parking Space Markings	3B-37
Section 3B.19 Pavement Word and Symbol Markings.....	3B-37
Section 3B.20 Speed Measurement Markings	3B-48
Section 3B.21 Curb Markings	3B-48
Section 3B.22 Preferential Lane Word and Symbol Markings	3B-49
Section 3B.23 Preferential Lane Longitudinal Markings for Motorized Vehicles ...	3B-50
Section 3B.24 Markings for Roundabouts	3B-55
Section 3B.25 Markings for Other Circular Intersections	3B-56
Section 3B.26 Speed Hump Markings	3B-56
Section 3B.27 Advance Speed Hump Markings.....	3B-59

CHAPTER 3C. OBJECT MARKERSDec., 2000

Section 3C.01 Object Marker Design and Placement Height.....3C-1
 Section 3C.02 Markings for Objects in the Roadway.....3C-3
 Section 3C.03 Markings for Objects Adjacent to the Roadway3C-3
 Section 3C.04 End-of-Roadway Markings3C-4

CHAPTER 3D. DELINEATORSDec., 2000

Section 3D.01 Delineators.....3D-1
 Section 3D.02 Delineator Design.....3D-1
 Section 3D.03 Delineator Application3D-1
 Section 3D.04 Delineator Placement and Spacing.....3D-3

CHAPTER 3E. COLORED PAVEMENTSDec., 2000

Section 3E.01 General.....3E-1

CHAPTER 3F. BARRICADES AND CHANNELIZING DEVICES .Dec., 2000

Section 3F.01 Barricades.....3F-1
 Section 3F.02 Channelizing Devices3F-1

CHAPTER 3G. ISLANDSDec., 2000

Section 3G.01 General3G-1
 Section 3G.02 Approach-End Treatment3G-1
 Section 3G.03 Island Marking Application.....3G-2
 Section 3G.04 Island Marking Colors.....3G-2
 Section 3G.05 Island Object Markers3G-3
 Section 3G.06 Island Delineators.....3G-3

FIGURES

CHAPTER 3B. PAVEMENT AND CURB MARKINGS

Figure 3B-1 Typical Two-Lane, Two-Way Marking Applications3B-2
 Figure 3B-2 Typical Four-or-More Lane, Two-Way Marking Applications3B-3
 Figure 3B-3 Typical Three-lane, Two-Way Marking Applications3B-5
 Figure 3B-4 Typical Three-Lane, Two-Way Marking for Changing
 Direction of the Center Lane3B-7
 Figure 3B-5 Method of Locating and Determining the Limits of
 No-Passing Zones at Curves.....3B-10
 Figure 3B-6 Typical Reversible Lane Marking Application3B-12
 Figure 3B-7 Typical Two-Way Left-Turn Lane Marking Applications.....3B-13
 Figure 3B-8 Typical Exit Ramp and Cloverleaf Ramp Markings3B-16
 Figure 3B-9 Typical Entrance Ramp Markings3B-18

Figure 3B-10	Typical Lane Drop Markings at Exit Ramps.....	3B-20
Figure 3B-11	Typical Pavement Marking Applications	3B-23
Figure 3B-12	Typical Lane Reduction Transition Markings	3B-25
Figure 3B-13	Typical Markings for Obstructions in the Roadway	3B-28
Figure 3B-14	Typical Yield Line Layout for Streets and Highways	3B-33
Figure 3B-15	Typical Types of Crosswalk Markings	3B-36
Figure 3B-16	Typical Crosswalk Markings for Exclusive Pedestrian Phase that Permits Diagonal Crossing	3B-36
Figure 3B-17	Typical Parking Space Markings.....	3B-38
Figure 3B-18	International Symbol of Accessibility Parking Space Marking with Blue Background and White Border Options	3B-39
Figure 3B-19	Typical Elongated Letters for Word Pavement Markings	3B-39
Figure 3B-20	Typical Lane-Use, Lane Reduction, and Wrong-Way Arrows for Pavement Markings	3B-40
Figure 3B-21	Typical Lane Use Control Word and Symbol Markings	3B-43
Figure 3B-22	Typical Arrow Markings at Exit-Ramp Terminals to Deter Wrong-Way Entry.....	3B-44
Figure 3B-23	Typical Arrow Markings at Entrance Ramp Terminals Where Design Does Not Clearly Indicate the Direction of Flow.....	3B-45
Figure 3B-24	Typical Yield Ahead Triangle Symbols for Streets and Highways...	3B-46
Figure 3B-25	Typical Markings for Preferential Lanes for Motorized Vehicles.....	3B-53
Figure 3B-26	Typical Markings for Roundabouts with One Lane	3B-57
Figure 3B-27	Typical Markings for Roundabouts with Two Lanes	3B-58
Figure 3B-28	Typical Pavement Markings for Speed Humps.....	3B-60
Figure 3B-29	Typical Pavement Markings for Speed Tables or Speed Humps with Crosswalks	3B-61
Figure 3B-30	Typical Advance Warning Markings for Speed Humps.....	3B-62

CHAPTER 3D. DELINEATORS

Figure 3D-1	Typical Delineator Installation	3D-5
-------------	---------------------------------------	------

TABLES

CHAPTER 3B. PAVEMENT AND CURB MARKINGS

Table 3B-1	Minimum Passing Sight Distances.....	3B-9
Table 3B-2	Standard Edge Line Lane Markings for Preferential Lanes.....	3B-52

CHAPTER 3D. DELINEATORS

Table 3D-1	Approximate Spacing for Delineators on Horizontal Curves	3D-6
------------	--	------

CHAPTER 3A. GENERAL

Section 3A.01 Functions and Limitations

Support:

Markings on highways have important functions in providing guidance and information for the road user. Major marking types include pavement and curb markings, object markers, delineators, colored pavements, barricades, channelizing devices and islands. In some cases, markings are used to supplement other traffic control devices such as signs, signals and other markings. In other instances, markings are used alone to effectively convey regulations, guidance, or warnings in ways not obtainable by the use of other devices.

Markings have limitations. Visibility of the markings can be limited by snow, debris, and water on or adjacent to the markings. Marking durability is affected by material characteristics, traffic volumes, weather, and location. However, under most highway conditions, markings provide important information while allowing minimal diversion of attention from the roadway.

Pavement markings can enhance roadway delineation with the addition of audible and tactile features such as bars, differential surface profiles, raised pavement markers, or other devices intended to alert the road user that a delineation on the roadway is being traversed.

Section 3A.02 Standardization of Application

Standard:

Each standard marking shall be used only to convey the meaning prescribed for that marking in this Manual. When used for applications not described herein, markings shall conform in all respects to the principles and standards set forth herein.

Guidance:

Before any new highway, paved detour, or temporary route is opened to traffic, all necessary markings should be in place.

Standard:

Markings that are no longer applicable for roadway conditions or restrictions and that might cause confusion for the road user shall be removed or obliterated to be unidentifiable as a marking as soon as practical. Markings that must be visible at night shall be retroreflective unless ambient illumination assures that the markings are adequately visible. All markings on Interstate highways shall be retroreflective.

Option:

Markings may be temporarily masked with tape until they can be removed or obliterated.

Section 3A.03 Materials

Support:

Pavement and curb markings are commonly placed by using paints or thermoplastics; however, other suitable marking materials, including raised pavement markers and colored pavements, are also used. Delineators, object markers, barricades, and channelizing devices are visibly placed in a vertical position similar to signs above the roadway.

Guidance:

The materials used for markings should provide the specified color throughout their useful life.

Consideration should be given to selecting pavement marking materials that will minimize tripping or loss of traction for pedestrians and bicyclists.

Object markers and delineators should not present a vertical or horizontal clearance obstacle for pedestrians.

Section 3A.04 Colors

Standard:

Markings shall be yellow, white, red, or blue. The colors for markings shall conform to the standard highway colors. Black in conjunction with one of the above colors shall be a usable color for object markers.

Option:

Black may be used in combination with the above colors where a light-colored pavement does not provide sufficient contrast with the markings.

Support:

When used in combination with other colors, black is not considered a marking color, but only a contrast-enhancing system for the markings.

Section 3A.05 Colors of Longitudinal Pavement Markings**Standard:**

The colors of longitudinal pavement markings shall conform to the following basic concepts:

A. Yellow lines delineate:

1. The separation of traffic traveling in opposite directions.
2. The left edge of the roadways of divided and one-way highways and ramps.
3. The separation of two-way left turn lanes and reversible lanes from other lanes.

B. White lines delineate:

1. The separation of traffic flows in the same direction.
2. The right edge of the roadway.

C. Red markings delineate roadways that shall not be entered or used.**D. Blue markings delineate parking spaces for persons with disabilities.****Section 3A.06 Widths and Patterns of Longitudinal Pavement Markings****Standard:**

The widths and patterns of longitudinal lines shall be as follows:

- A. A solid line prohibits or discourages crossing.
- B. A normal line is 100 to 150 mm (4 to 6 in) wide.
- C. A wide line is at least twice the width of a normal line. The width of the line indicates the degree of emphasis.
- D. A double line consists of two normal lines separated by a discernible space. A double line indicates maximum or special restrictions.

- E. A broken line consists of normal line segments separated by gaps. A broken line indicates a permissive condition.**
- F. A dotted line shall consist of noticeably shorter line segments separated by shorter gaps than used for a broken line. The width of a dotted line shall be at least the same as the width of the line it extends. A dotted line provides guidance.**
- G. The value of N for a broken or dotted line shall equal the length of one line segment plus one gap. The value of N referenced for solid lines shall equal the N for the broken or dotted lines that might be adjacent to or might extend the solid lines (see Sections 3B.13 and 3B.14).**

Guidance:

On rural highways, broken lines should consist of 3 m (10 ft) line segments and 9 m (30 ft) gaps, or similar dimensions in a similar ratio of line segments to gaps as appropriate for traffic speeds and need for delineation.

Option:

A dotted line may consist of 0.6 m (2 ft) line segments, and 1.2 m (4 ft) or longer gaps with a maximum segment-to-gap ratio of 1-to-3.

CHAPTER 3B. PAVEMENT AND CURB MARKINGS

Section 3B.01 Yellow Centerline and Left Edge Line Pavement Markings and Warrants

Standard:

Centerline pavement markings, when used, shall be the pavement markings used to delineate the separation of traffic lanes that have opposite directions of travel on a roadway and shall be yellow.

Option:

Centerline pavement markings may be placed at a location that is not the geometrical center of the roadway.

On roadways without continuous centerline pavement markings, short sections may be marked with centerline pavement markings to control the position of traffic at specific locations, such as around curves, over hills, on approaches to highway-railroad grade crossings, at highway-railroad grade crossings, and at bridges.

Standard:

The centerline markings on two-lane, two-way roadways shall be one of the following as shown in Figure 3B-1:

- A. Two-direction passing zone markings consisting of a normal broken yellow line where crossing the centerline markings for passing with care is permitted for traffic traveling in either direction.**
- B. One-direction no-passing zone markings consisting of a normal broken yellow line and a normal solid yellow line where crossing the centerline markings for passing with care is permitted for the traffic traveling adjacent to the broken line, but is prohibited for traffic traveling adjacent to the solid line.**
- C. Two-direction no-passing zone markings consisting of two normal solid yellow lines where crossing the centerline markings for passing is prohibited for traffic traveling in either direction.**

The centerline markings on undivided two-way roadways with four or more traffic lanes always available shall be the two-direction no-passing zone markings consisting of two normal solid yellow lines as shown in Figure 3B-2.

Figure 3B-1. Typical Two-Lane, Two-Way Marking Applications

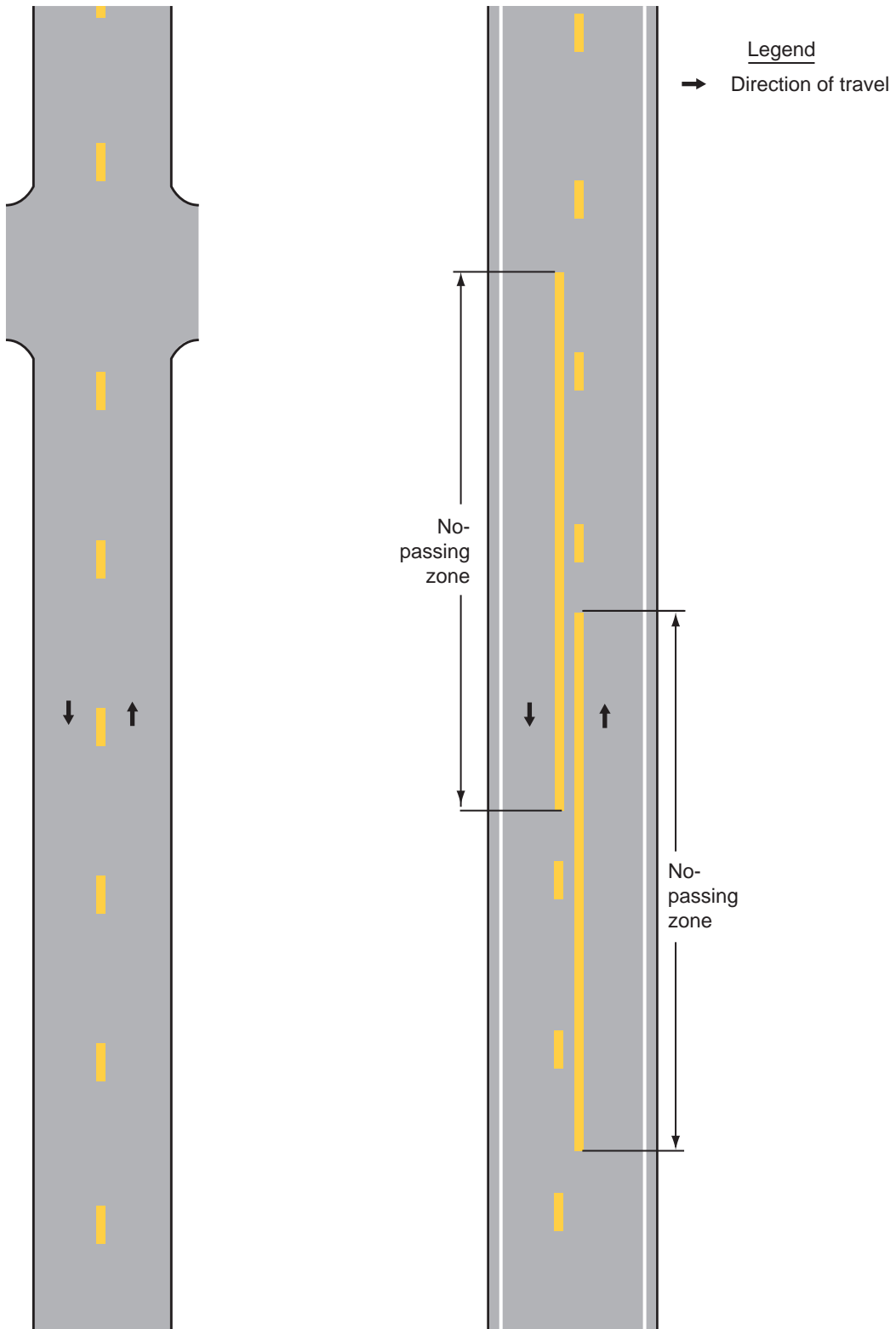

a - Typical two-lane, two-way marking with passing permitted in both directions

b - Typical two-lane, two-way marking with no-passing zones

Figure 3B-2. Typical Four-or-More Lane, Two-Way Marking Applications

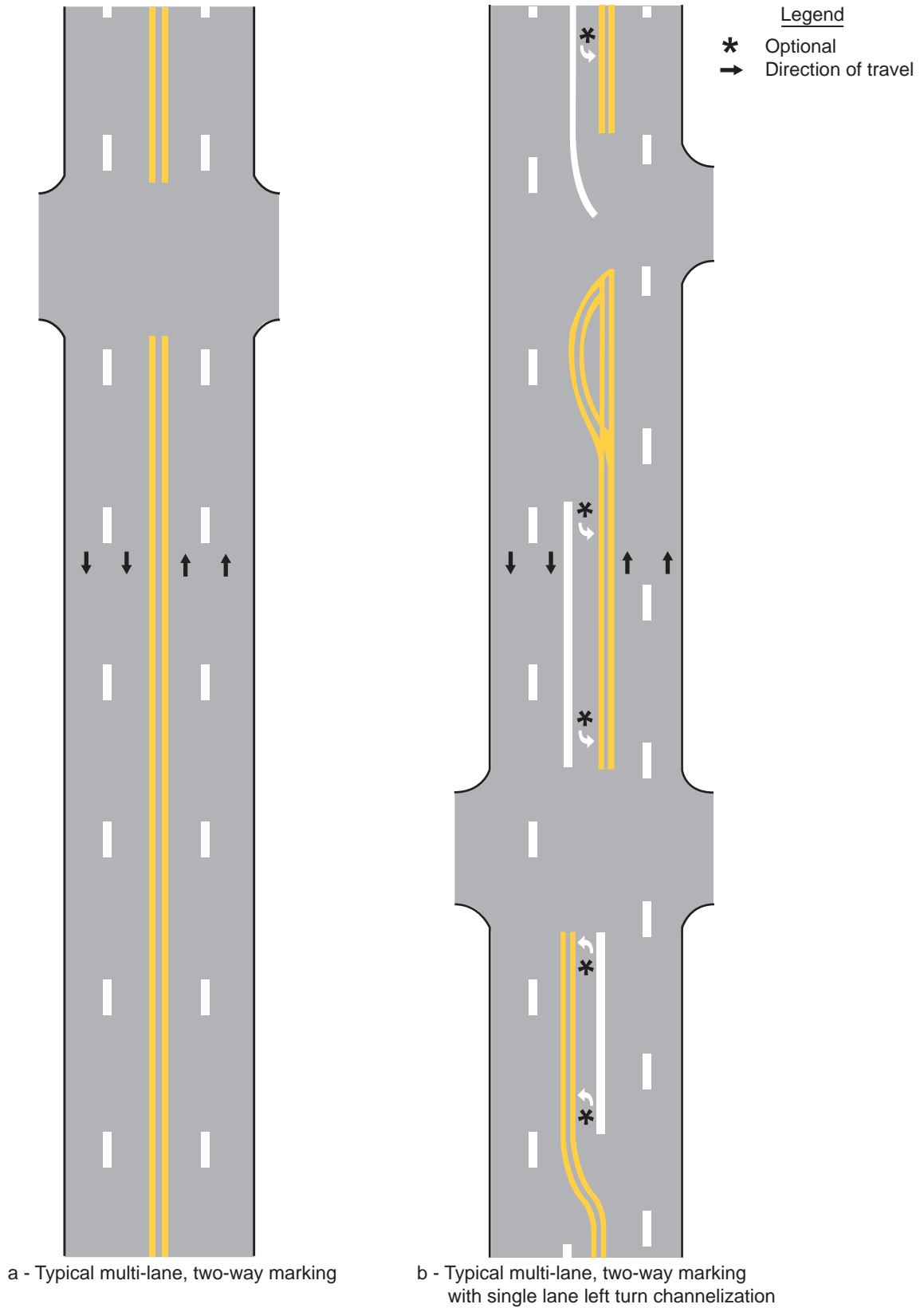

Guidance:

On two-way roadways with three traffic lanes, two lanes should be designated for traffic in one direction by using one- or two-direction no-passing zone markings as shown in Figure 3B-3.

Standard:

Centerline markings shall be placed on all paved urban arterials and collectors that have a traveled width of 6.1 m (20 ft) or more and an ADT of 6,000 vehicles per day or greater. Centerline markings shall also be placed on all paved two-way streets or highways that have three or more traffic lanes.

Guidance:

Centerline markings should be placed on paved urban arterials and collectors that have a traveled width of 6.1 m (20 ft) or more and an ADT of 4,000 vehicles per day or greater. Centerline markings should also be placed on all rural arterials and collectors that have a traveled width of 5.5 m (18 ft) or more and an ADT of 3,000 vehicles per day or greater. Centerline markings should also be placed on other traveled ways where an engineering study indicates such a need.

Engineering judgment should be used in determining whether to place centerline markings on traveled ways that are less than 4.9 m (16 ft) wide because of the potential for traffic encroaching on the pavement edges, traffic being affected by parked vehicles, and traffic encroaching into the opposing traffic lane.

Option:

Centerline markings may be placed on other paved two-way traveled ways that are 4.9 m (16 ft) or more in width.

If a traffic count is not available, the ADTs described in this Section may be estimates that are based on engineering judgment.

Standard:

If used on the roadways of divided highways or one-way streets, or on any ramp in the direction of travel (see Section 3B.06), left edge line pavement markings shall consist of a normal solid yellow line to delineate the left edge of a roadway or to indicate driving or passing restrictions left of these markings.

Figure 3B-3. Typical Three-Lane, Two-Way Marking Applications

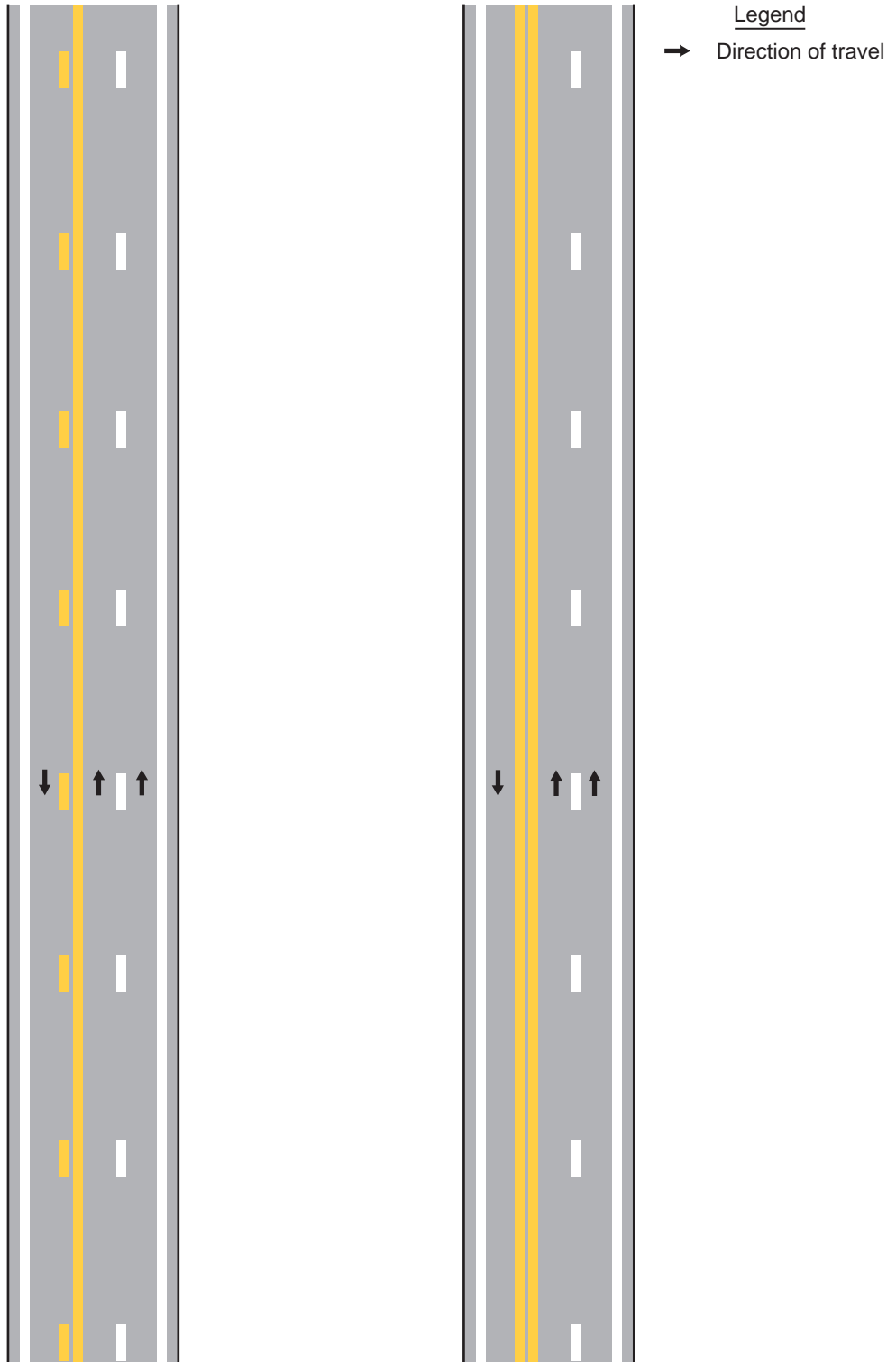

a - Typical three-lane, two-way marking with passing permitted in single-lane direction

b - Typical three-lane, two-way marking with passing prohibited in single-lane direction

Section 3B.02 No-Passing Zone Pavement Markings and Warrants**Standard:**

No-passing zones shall be marked by either the one direction no-passing zone pavement markings or the two-direction no-passing zone pavement markings described previously and shown in Figures 3B-1 and 3B-3.

When centerline markings are used, no-passing zone markings shall be used on two-way roadways at lane reduction transitions (see Section 3B.09) and on approaches to obstructions that must be passed on the right (see Section 3B.10).

Guidance:

Where the distance between successive no-passing zones is less than 120 m (400 ft), no-passing markings should connect the zones.

Standard:

No-passing zone markings shall be used on approaches to highway-rail grade crossings (see Section 8B.16) and at other locations where the prohibition of passing is appropriate.

Option:

In addition to pavement markings, no-passing zone signs (see Sections 2B.24, 2B.25, and 2C.32) may be used to emphasize the existence and extent of a no-passing zone.

Support:

Section 11-307 of the "Uniform Vehicle Code (UVC) Revised" contains further information regarding no-passing zones. The "UVC" can be obtained from the National Committee on Uniform Traffic Laws and Ordinances at the address shown on Page i.

Standard:

On two-way, two- or three-lane roadways where centerline markings are installed, no-passing zones shall be established at vertical and horizontal curves and other locations where an engineering study indicates that passing must be prohibited because of inadequate sight distances or other special conditions.

On three-lane roadways where the direction of travel in the center lane transitions from one direction to the other, a no-passing buffer zone shall be provided in the center lane as shown in Figure 3B-4. A lane transition shall be provided at each end of the buffer zone.

Figure 3B-4. Typical Three-Lane, Two-Way Marking for Changing Direction of the Center Lane

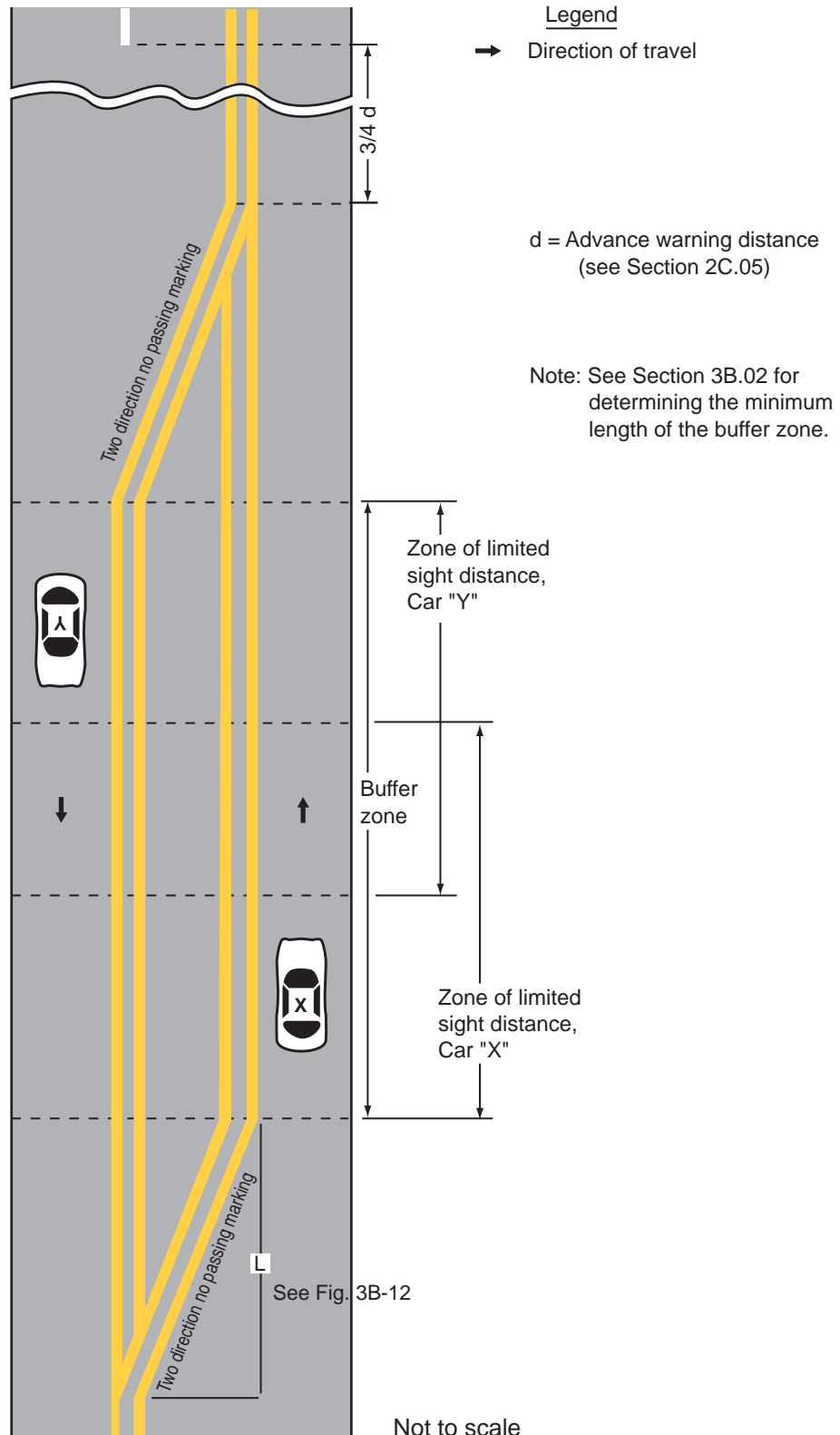

The buffer zone shall be a median island consisting of a lane transition in each direction and a minimum of a 15 m (50 ft) buffer zone. In areas where no-passing zones are required because of limited passing sight distances, the buffer zone shall be the distances between the beginnings of the no-passing zones in each direction.

Guidance:

For three-lane roadways having a posted or statutory speed limit of 70 km/h (45 mph) or greater, the lane transition taper length should be computed by the formula $L = 0.62 WS$ for speeds in km/h ($L = WS$ for speeds in mph). For roadways where the posted or statutory speed limit is less than 70 km/h (45 mph), the formula $L = WS^2/155$ for speeds in km/h ($L = WS^2/60$ for speeds in mph) should be used to compute taper length. Under both formulas, L equals the taper length in meters (feet), W equals the width of the center lane or offset distance in meters (feet), and S equals the 85th-percentile speed or the posted or statutory speed limit, whichever is higher.

Standard:

The minimum lane transition taper length shall be 30 m (100 ft) in urban areas and 60 m (200 ft) in rural areas.

On roadways with centerline markings, no-passing zone markings shall be used at horizontal or vertical curves where the passing sight distance is less than the minimum necessary for safe passing at the 85th-percentile speed or the posted or statutory speed limit as shown in Table 3B-1. The passing sight distance on a vertical curve is the distance at which an object 1.07 m (3.5 ft) above the pavement surface can be seen from a point 1.07 m (3.5 ft) above the pavement (see Figure 3B-5). Similarly, the passing sight distance on a horizontal curve is the distance measured along the centerline (or right-hand lane line of a three-lane roadway) between two points 1.07 m (3.5 ft) above the pavement on a line tangent to the embankment or other obstruction that cuts off the view on the inside of the curve (see Figure 3B-5).

Support:

The beginning of a no-passing zone at point "a" in Figure 3B-5 is that point where the sight distance first becomes less than that specified in Table 3B-1. The end of the no-passing zone at point "b" in Figure 3B-5 is that point at which the sight distance again becomes greater than the minimum specified.

Table 3B-1. Minimum Passing Sight Distances

85th- Percentile or Posted or Statutory Speed Limit (km/h)	Minimum Passing Sight Distance (meters)
40	140
50	160
60	180
70	210
80	245
90	280
100	320
110	355
120	395

85th- Percentile or Posted or Statutory Speed Limit (mph)	Minimum Passing Sight Distance (feet)
25	450
30	500
35	550
40	600
45	700
50	800
55	900
60	1,000
65	1,100
70	1,200

Figure 3B-5. Method of Locating and Determining the Limits of No-Passing Zones at Curves

a - No-passing zone at VERTICAL CURVE.

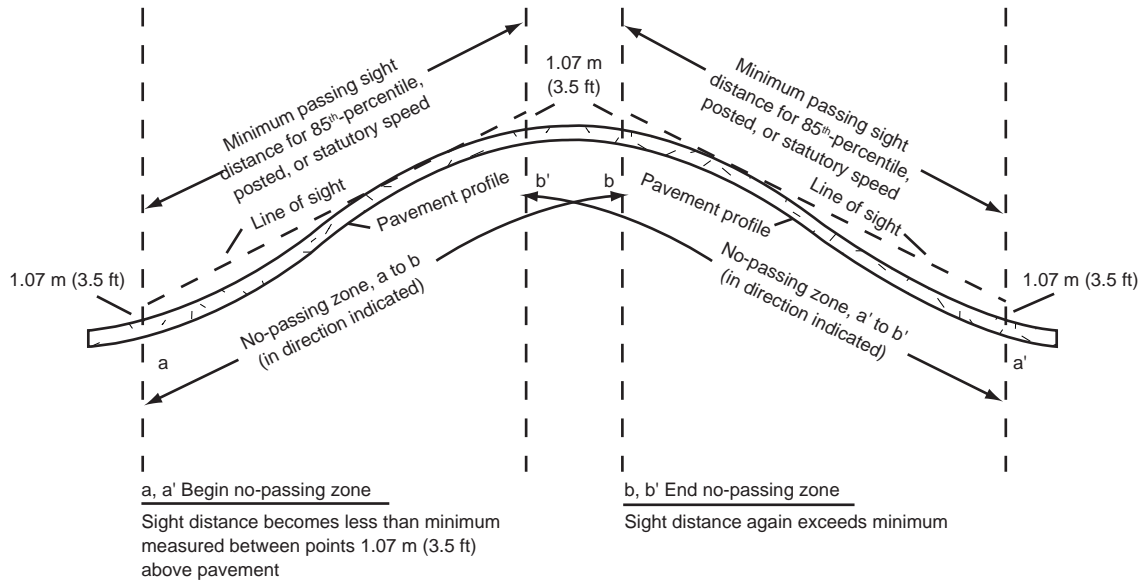

Note: No-passing zones in opposite directions may or may not overlap, depending on alignment.

b - No-passing zone at HORIZONTAL CURVE.

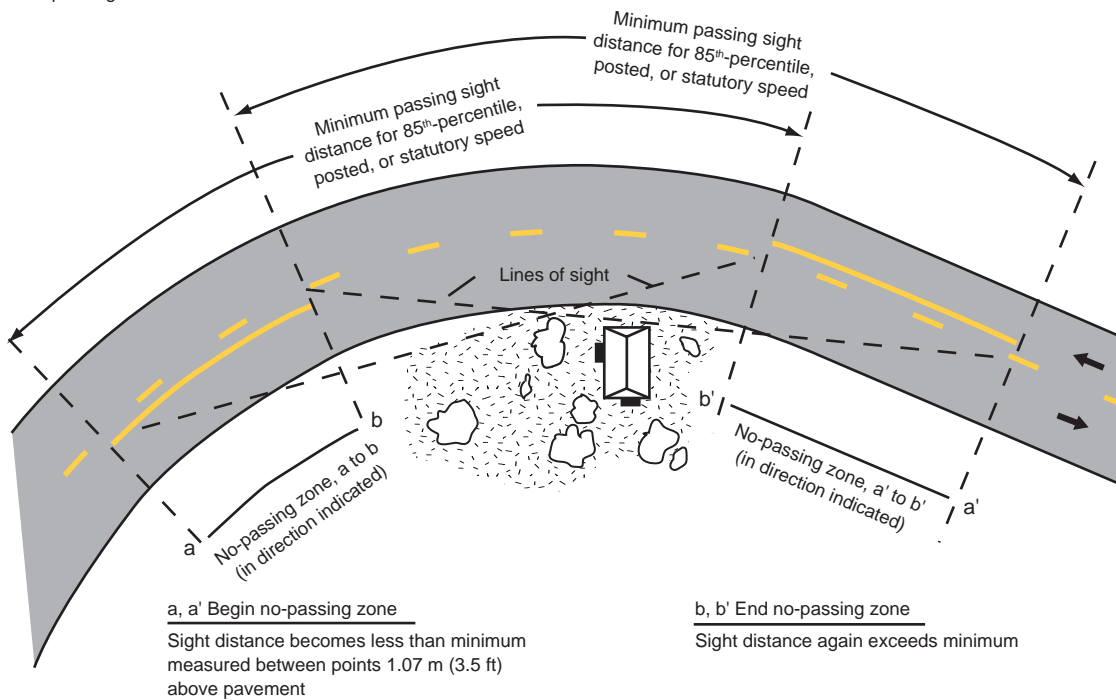

Note: No-passing zones in opposite directions may or may not overlap, depending on alignment.

Section 3B.03 Other Yellow Longitudinal Pavement Markings**Standard:**

If reversible lanes are used, the lane line pavement markings on each side of reversible lanes shall consist of two normal broken yellow lines to delineate the edges of a lane in which the direction of travel is reversed from time to time, such that each of these markings serve as the centerline markings of the roadway during some period (see Figure 3B-6).

Signs (see Section 2B.23), lane-use control signals (see Chapter 4J), or both shall be used to supplement reversible lane pavement markings.

If a two-way left-turn lane is used, the lane line pavement markings on each side of the two-way left-turn lane shall consist of a normal broken yellow line and a normal solid yellow line to delineate the edges of a lane that can be used by traffic in either direction for part of a left-turn maneuver. These markings shall be placed with the broken line toward the two-way left-turn lane and the solid line toward the adjacent traffic lane as shown in Figure 3B-7.

Option:

Pavement marking arrows may be used in conjunction with the two-way left-turn lane markings as shown in Figure 3B-7.

Guidance:

Signs should be used in conjunction with the two-way left turn markings (see Section 2B.22).

Standard:

If a continuous median island formed by pavement markings separating travel in opposite directions is used, two sets of double solid yellow lines shall be used to form the island as shown in Figures 3B-2 and 3B-4. Other markings in the median island area shall also be yellow, except crosswalk markings which shall be white (see Section 3B.17).

Figure 3B-6. Typical Reversible Lane Marking Application

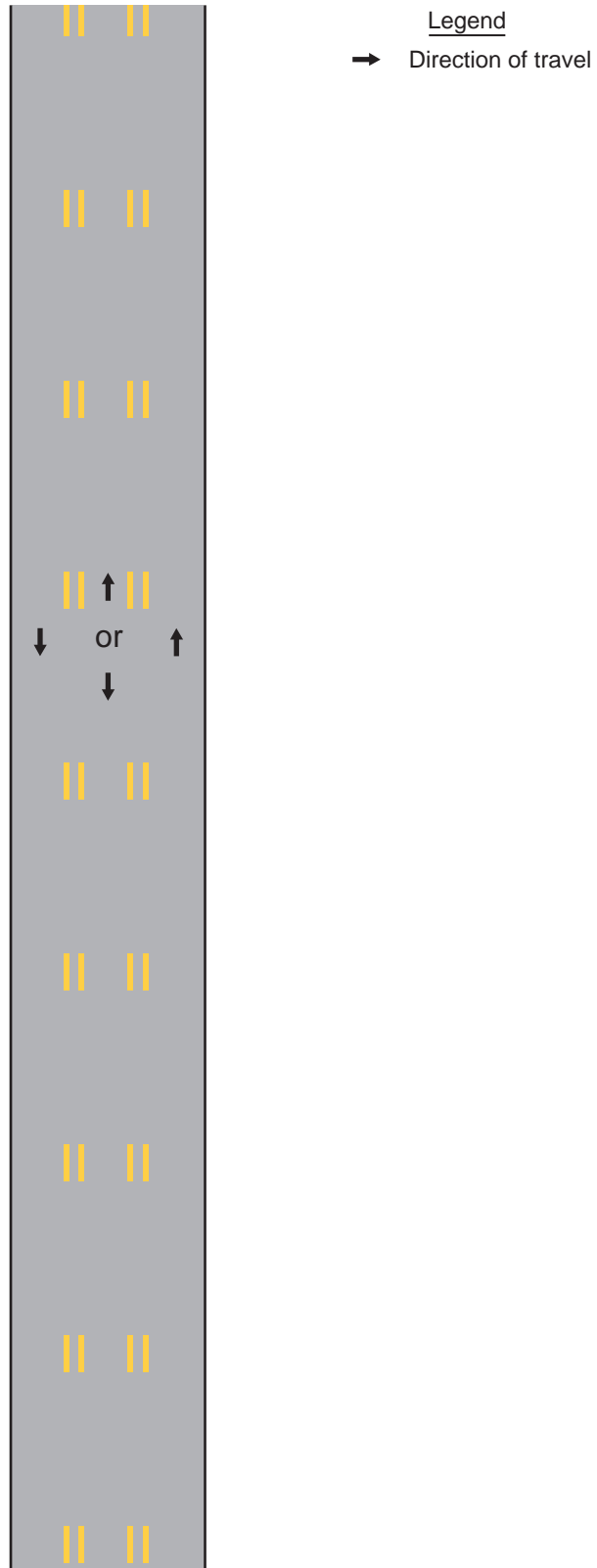
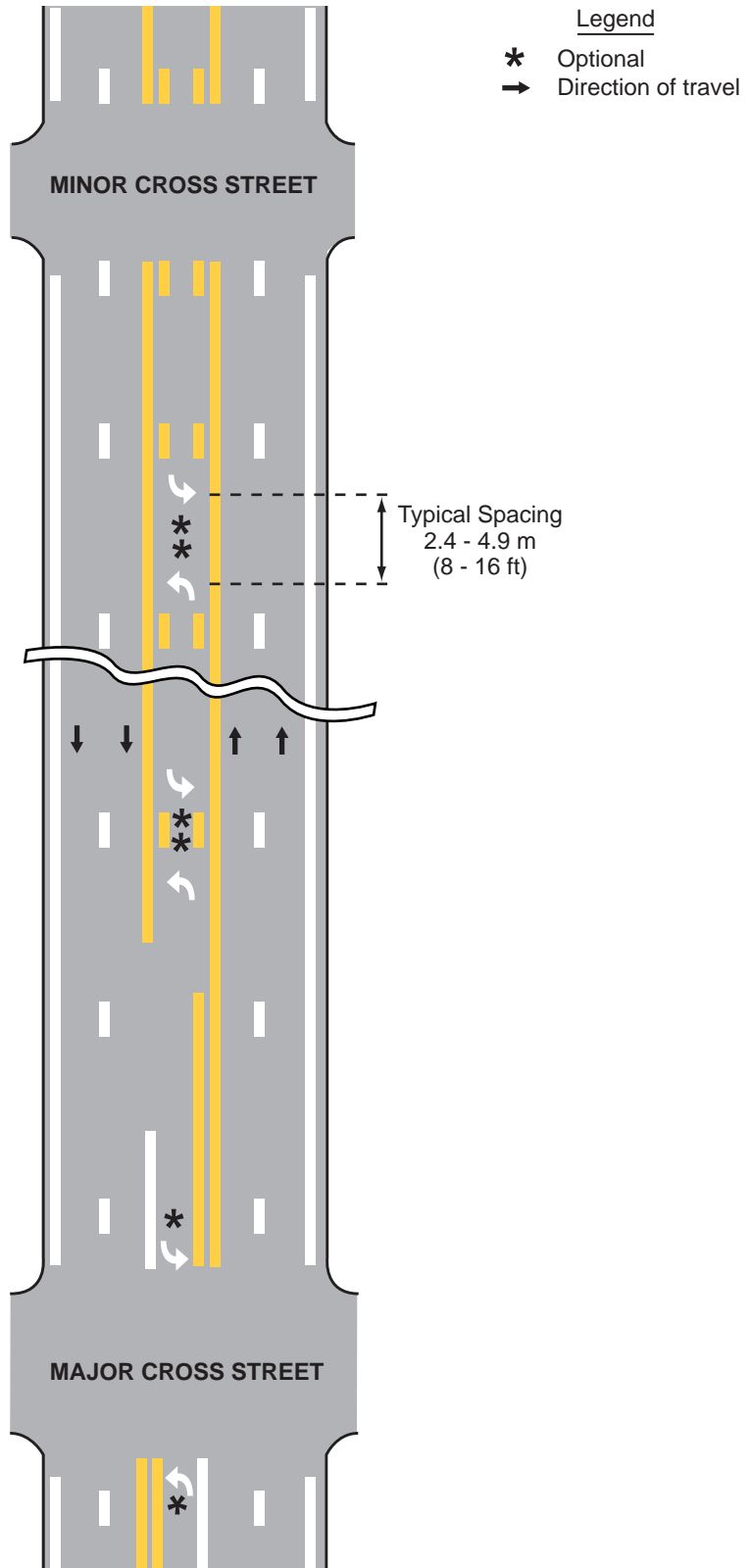

Figure 3B-7. Typical Two-Way Left-Turn Lane Marking Applications



Section 3B.04 White Lane Line and Right Edge Line Pavement Markings and Warrants

Standard:

When used, lane line pavement markings delineating the separation of traffic lanes that have the same direction of travel shall be white.

Support:

Typical applications of lane line markings are shown in Figures 3B-2, 3B-3, 3B-7 through 3B-13, 3B-21, 3B-23, and 3B-25.

Standard:

Where crossing the lane line markings with care is permitted, the lane line markings shall consist of a normal broken white line.

Where crossing the lane line markings is discouraged, the lane line markings shall consist of a normal solid white line.

Option:

Solid white lane line markings may be used to separate through traffic lanes from auxiliary lanes, such as uphill truck lanes, left- or right-turn lanes, and preferential lanes. They may also be used to separate traffic lanes approaching an intersection.

Wide solid lane line markings may be used for greater emphasis.

Standard:

Where crossing the lane line markings is prohibited, the lane line markings shall consist of two normal solid white lines.

Lane line markings shall be used on all freeways and Interstate highways.

Guidance:

Lane line markings should be used on all roadways with two or more adjacent traffic lanes that have the same direction of travel. Lane line markings should also be used at congested locations where the roadway will accommodate more traffic lanes with lane line markings than without the markings.

Standard:

If used, the right edge line pavement markings shall consist of a normal solid white line to delineate the right edge of the roadway.

Section 3B.05 Other White Longitudinal Pavement Markings**Standard:**

A channelizing line shall be a wide or double solid white line.

Option:

Channelizing lines may be used to form channelizing islands where traffic traveling in the same direction is permitted on both sides of the island.

Standard:

Other pavement markings in the channelizing island area shall be white.

Support:

Typical examples of channelizing line applications are shown in Figures 3B-8, 3B-9, and 3B-13.

Channelizing lines at exit ramps as shown in Figure 3B-8 define the neutral area, direct exiting traffic at the proper angle for smooth divergence from the main lanes into the ramp, and reduce the probability of colliding with objects adjacent to the roadway.

Channelizing lines at entrance ramps as shown in Figure 3B-9 promote safe and efficient merging with the through traffic.

Standard:

For exit ramps, channelizing lines shall be placed along the sides of the neutral area adjacent to the through traffic lane and the ramp lane. With a parallel deceleration lane, a lane line shall be extended from the beginning of the channelizing line upstream for a distance of one-half the length of the full-width deceleration lane as shown in Figure 3B-8.

Option:

White chevron markings may be placed in the neutral area for special emphasis as shown in Figure 3B-8.

Figure 3B-8. Typical Exit Ramp and Cloverleaf Ramp Markings (Sheet 1 of 2)

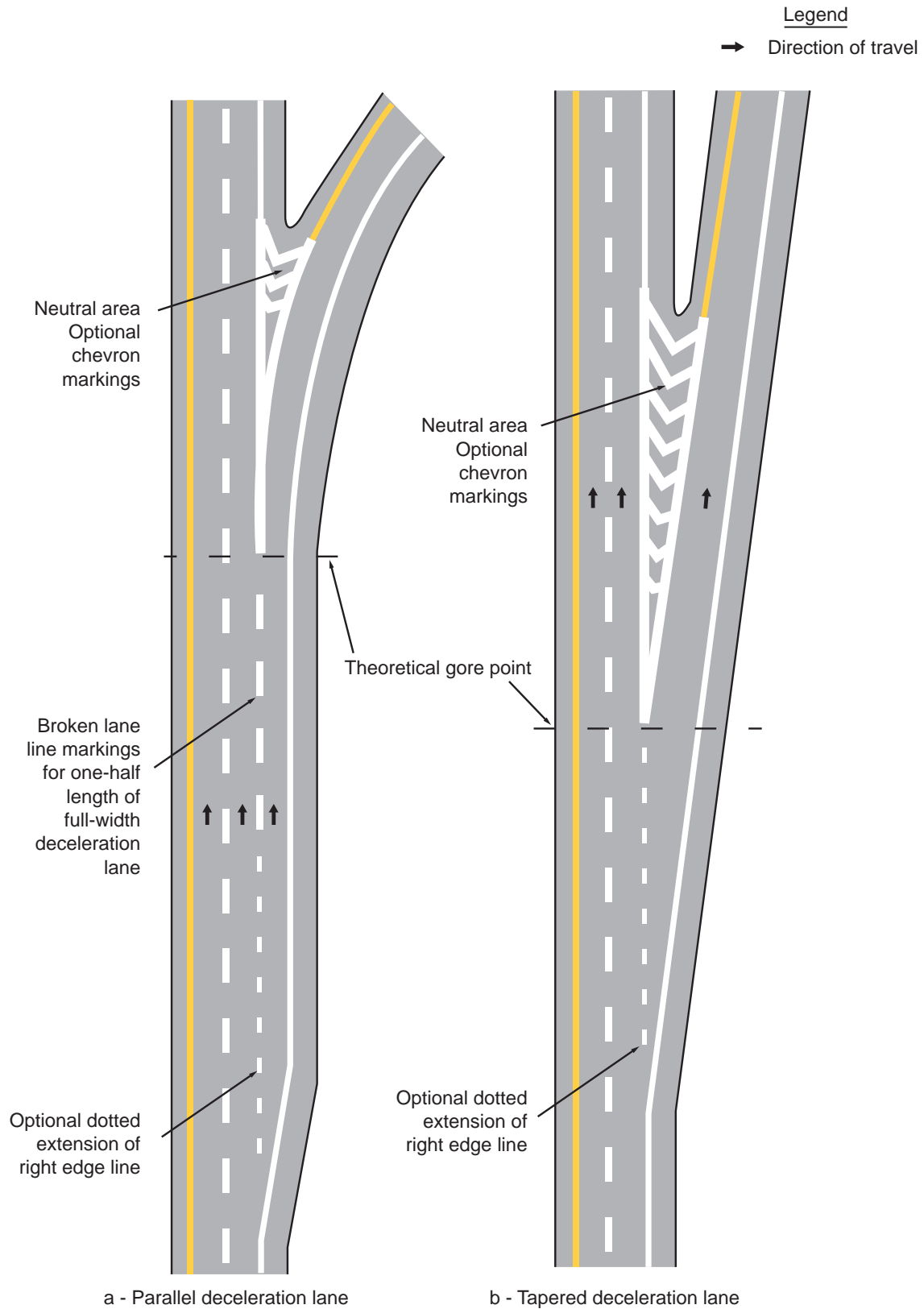

Figure 3B-8. Typical Exit Ramp and Cloverleaf Ramp Markings (Sheet 2 of 2)

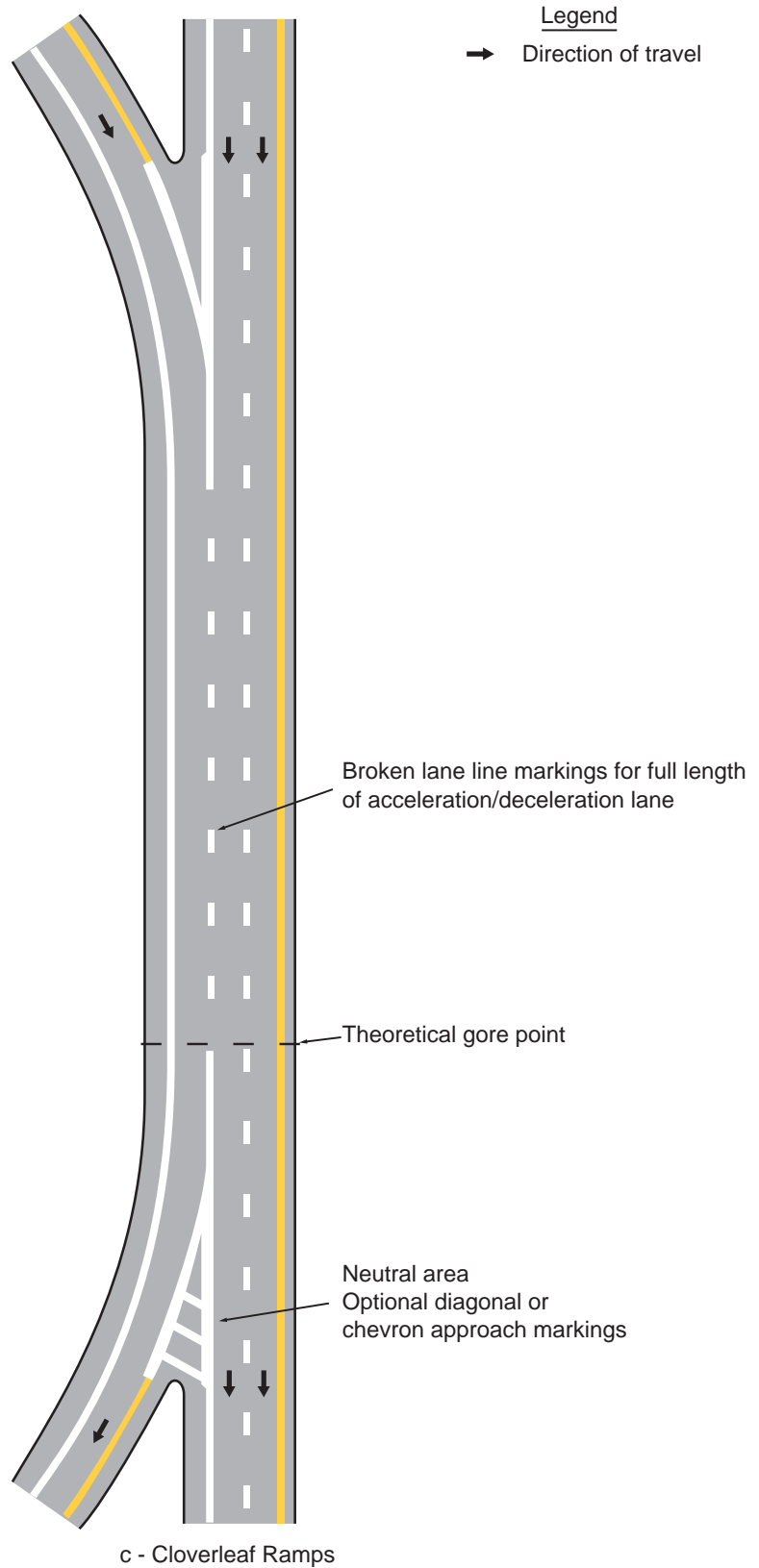
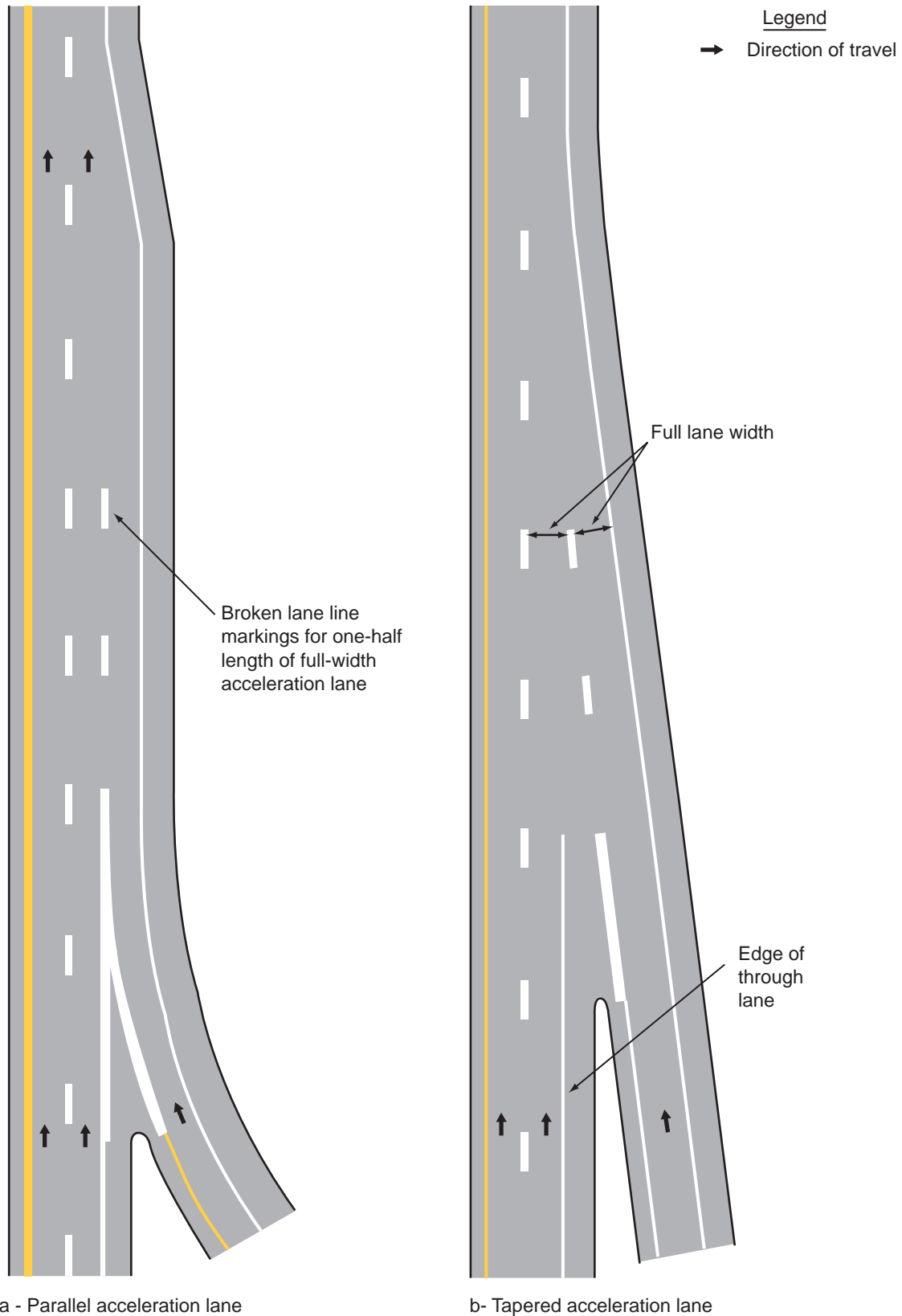

Figure 3B-9. Typical Entrance Ramp Markings



Guidance:

For entrance ramps, a channelizing line should be placed along the side of the neutral area adjacent to the ramp lane.

For entrance ramps with a parallel acceleration lane, a lane line should be extended from the end of the channelizing line for a distance of one-half the length of the full-width acceleration lane as shown in Figure 3B-9.

Option:

For entrance ramps with a tapered acceleration lane, lane line markings may be placed to extend the channelizing line, but not beyond a point where the tapered lane meets the near side of the through traffic lane as shown in Figure 3B-9.

Lane drop markings as shown in Figure 3B-10 may be used in advance of lane drops at exit ramps to distinguish a lane drop from a normal exit ramp or from an auxiliary lane. The lane drop marking may consist of a wide, white dotted line with line segments 0.9 m (3 ft) in length separated by 3.6 m (12 ft) gaps.

Guidance:

If used, lane drop markings should begin 800 m (0.5 mi) in advance of the theoretical gore point.

Option:

Where lane changes might cause conflicts, a wide solid white channelizing line may extend upstream from the theoretical gore point.

Section 3B.06 Edge Line Pavement Markings**Standard:**

If used, edge line pavement markings shall delineate the right or left edges of a roadway (see Sections 3B.01 and 3B.04).

Edge line markings shall not be continued through intersections, however edge line extensions (see Section 3B.08) may be placed through intersections.

Guidance:

Edge line markings should not be broken for driveways.

Figure 3B-10. Typical Lane Drop Markings at Exit Ramps

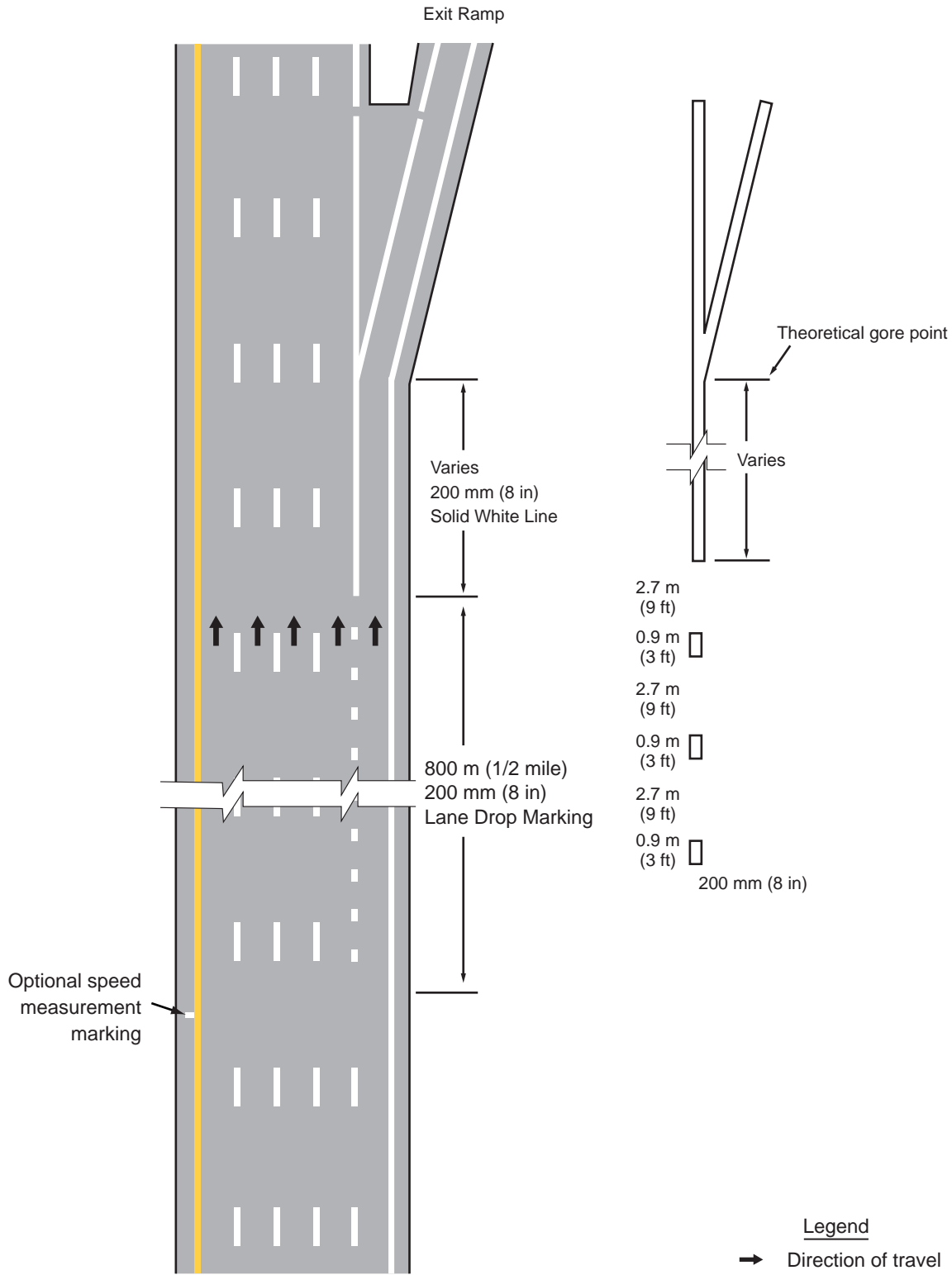

Support:

Edge line markings have unique value as visual references to guide road users during adverse weather and visibility conditions.

Section 3B.07 Warrants for Use of Edge Lines

Standard:

Edge line markings shall be placed on paved streets or highways with the following characteristics:

- A. Freeways.**
- B. Expressways.**
- C. Rural arterials with a traveled way of 6.1 m (20 ft) or more in width and an ADT of 6,000 vehicles per day or greater.**

Guidance:

Edge line markings should be placed on paved streets or highways with the following characteristics:

- A. Rural arterials and collectors with a traveled way of 6.1 m (20 ft) or more in width and an ADT of 3,000 vehicles per day or greater.
- B. At other paved streets and highways where an engineering study indicates a need for edge line markings.

Edge line markings should not be placed where an engineering study or engineering judgment indicates that providing them would decrease safety.

Option:

Edge line markings may be placed on streets and highways that do not have centerline markings.

Edge line markings may be excluded, based on engineering judgment, for reasons such as if the traveled way edges are delineated by curbs, parking, bicycle lanes, or other markings.

Edge line markings may be used where edge delineation is desirable to minimize unnecessary driving on paved shoulders or on refuge areas that have lesser structural pavement strength than the adjacent roadway.

Section 3B.08 Extensions Through Intersections or Interchanges**Standard:**

Pavement markings extended into or continued through an intersection or interchange area shall be the same color and at least the same width as the line markings they extend (see Figure 3B-11).

Guidance:

Where highway design or reduced visibility conditions make it desirable to provide control or to guide vehicles through an intersection or interchange, such as at offset, skewed, complex, or multi-legged intersections, on curved roadways, or where multiple turn lanes are used, dotted line markings should be used to extend longitudinal line markings through an intersection or interchange area.

Where greater restriction is required, solid lane lines or channelizing lines should be extended into or continued through intersections.

Section 3B.09 Lane Reduction Transition Markings**Standard:**

Where pavement markings are used, lane reduction transition markings shall be used to guide traffic through transition areas where the number of through lanes is reduced, as shown in Figure 3B-12. On two-way roadways, no-passing zone markings shall be used to prohibit passing in the direction of the convergence, and shall continue through the transition area.

Guidance:

For roadways having a posted or statutory speed limit of 70 km/h (45 mph) or greater, the transition taper length for a lane reduction should be computed by the formula $L = 0.62 WS$ for speeds in km/h ($L = WS$ for speeds in mph). For roadways where the posted or statutory speed limit is less than 70 km/h (45 mph), the formula $L = WS^2/155$ for speeds in km/h ($L = WS^2/60$ for speeds in mph) should be used to compute taper length. Under both formulas, L equals the taper length in meters (feet), W equals the width of the offset distance in meters (feet), and S equals the 85th-percentile speed or the posted or statutory speed limit, whichever is higher.

Where observed speeds exceed posted or statutory speed limits, longer tapers should be used.

Figure 3B-11. Typical Pavement Marking Applications (Sheet 1 of 2)

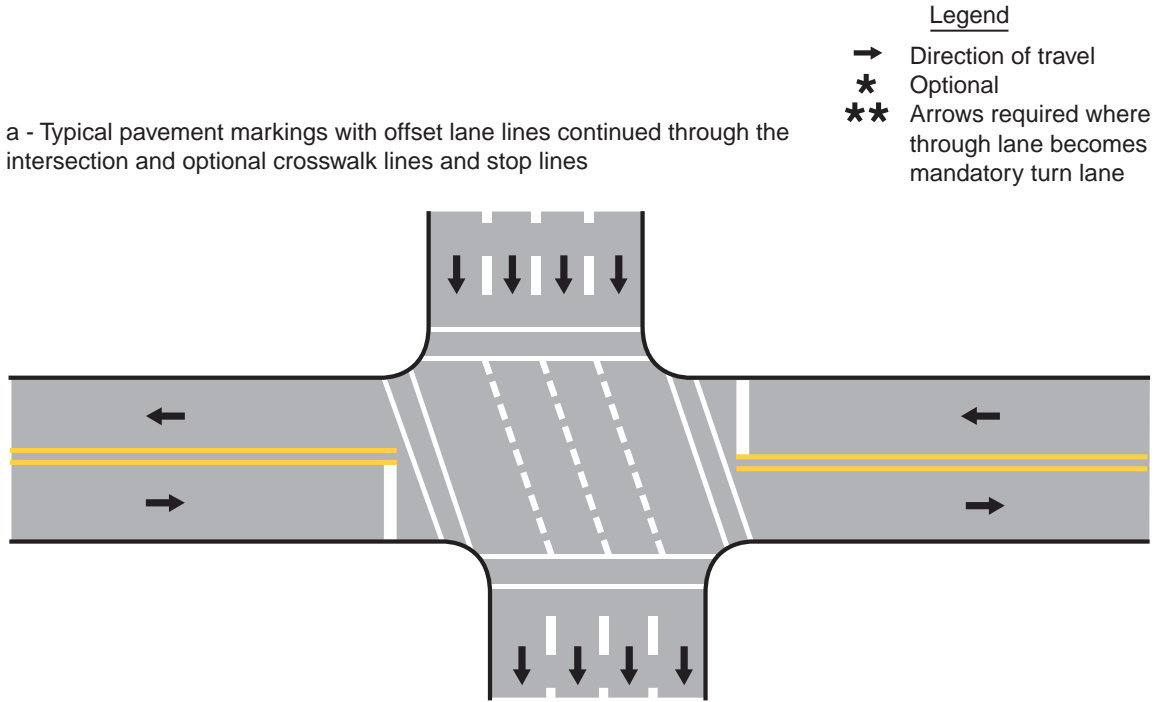

b - Typical pavement markings with optional double-turn lane lines, lane-use turn arrows, crosswalk lines, and stop lines

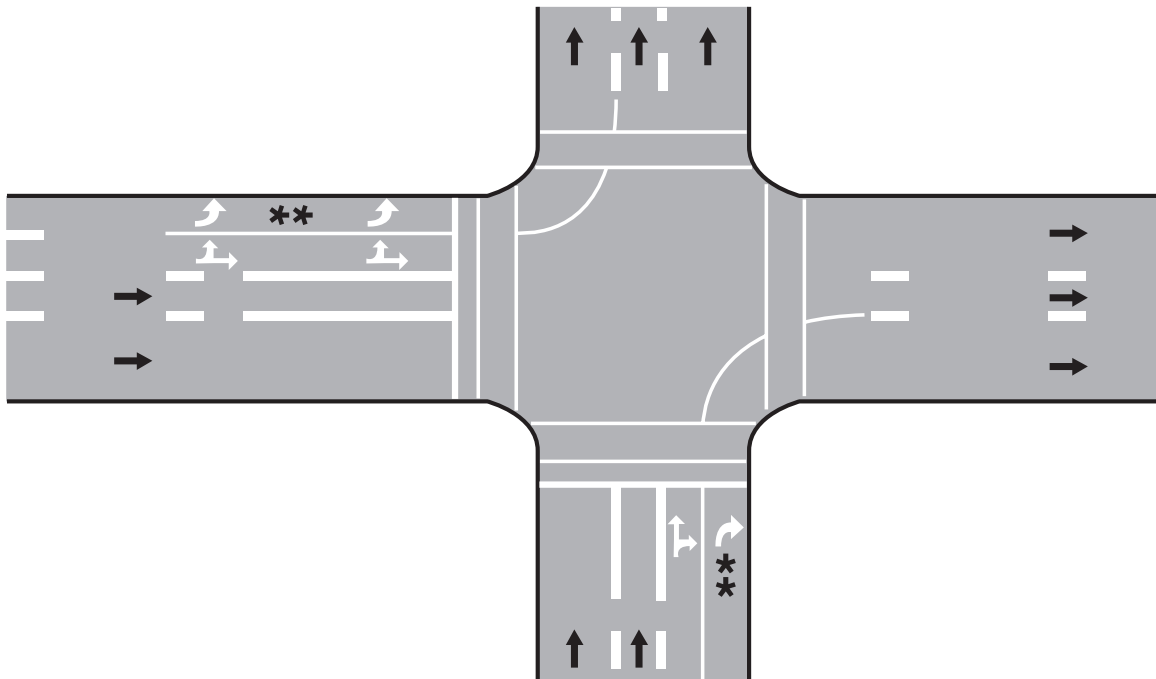
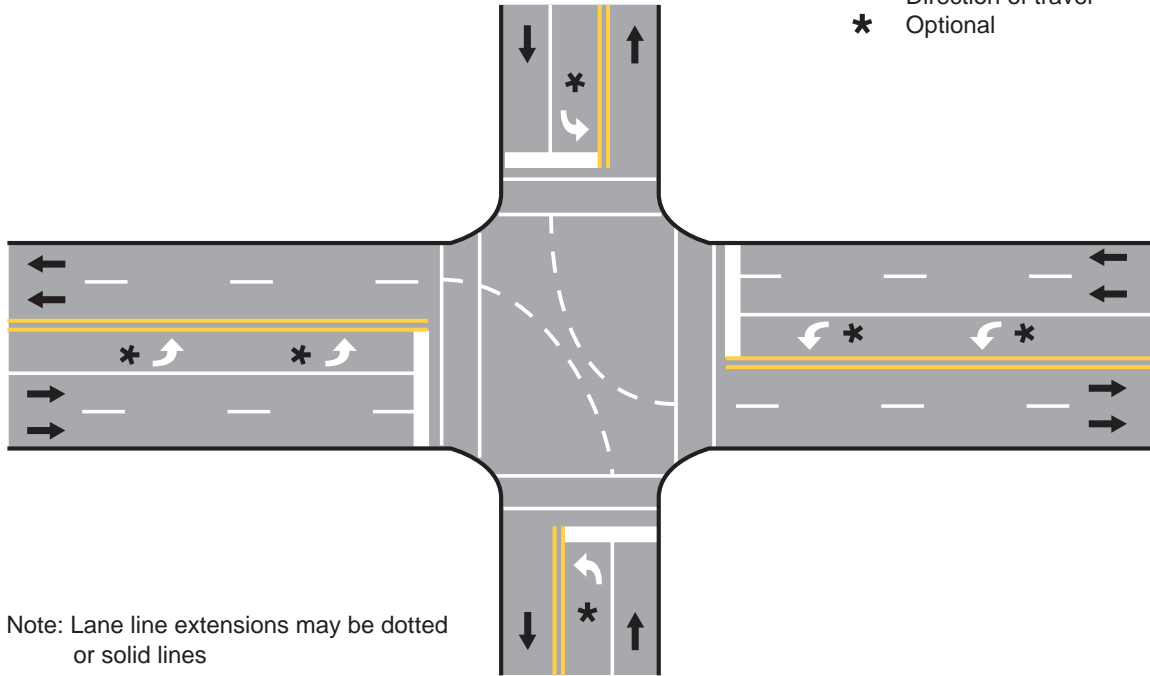

Figure 3B-11. Typical Pavement Marking Applications (Sheet 2 of 2)

c. - Typical dotted line markings to extend longitudinal lane line markings

- Legend
→ Direction of travel
* Optional



d. - Typical dotted line markings to extend longitudinal center line markings

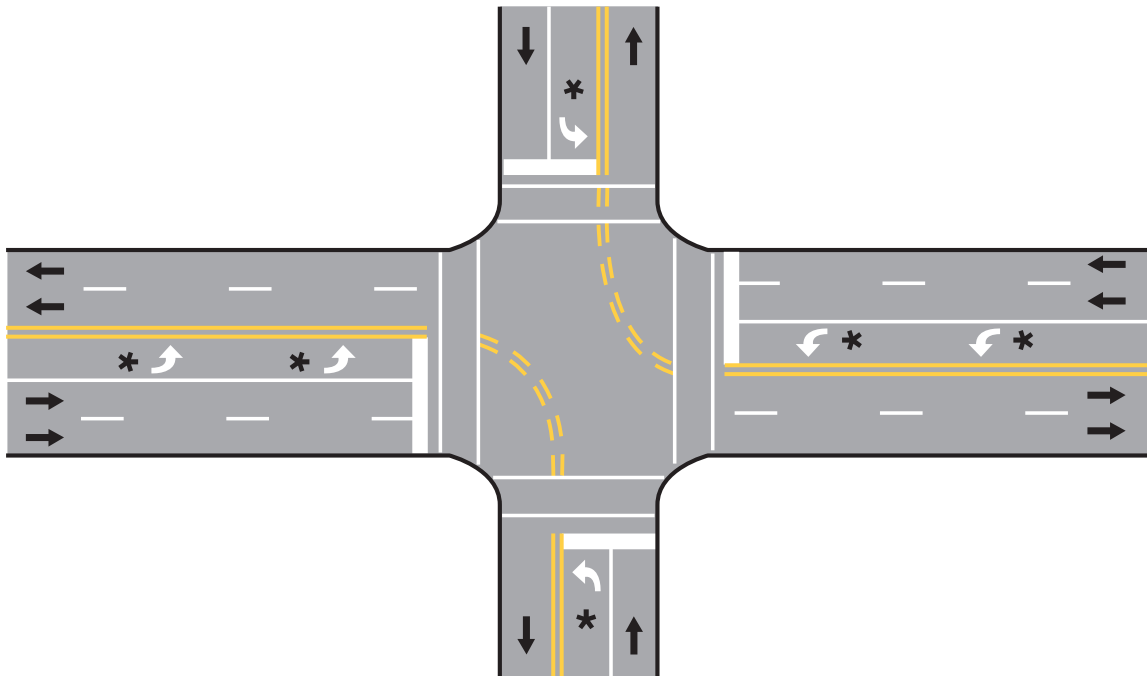
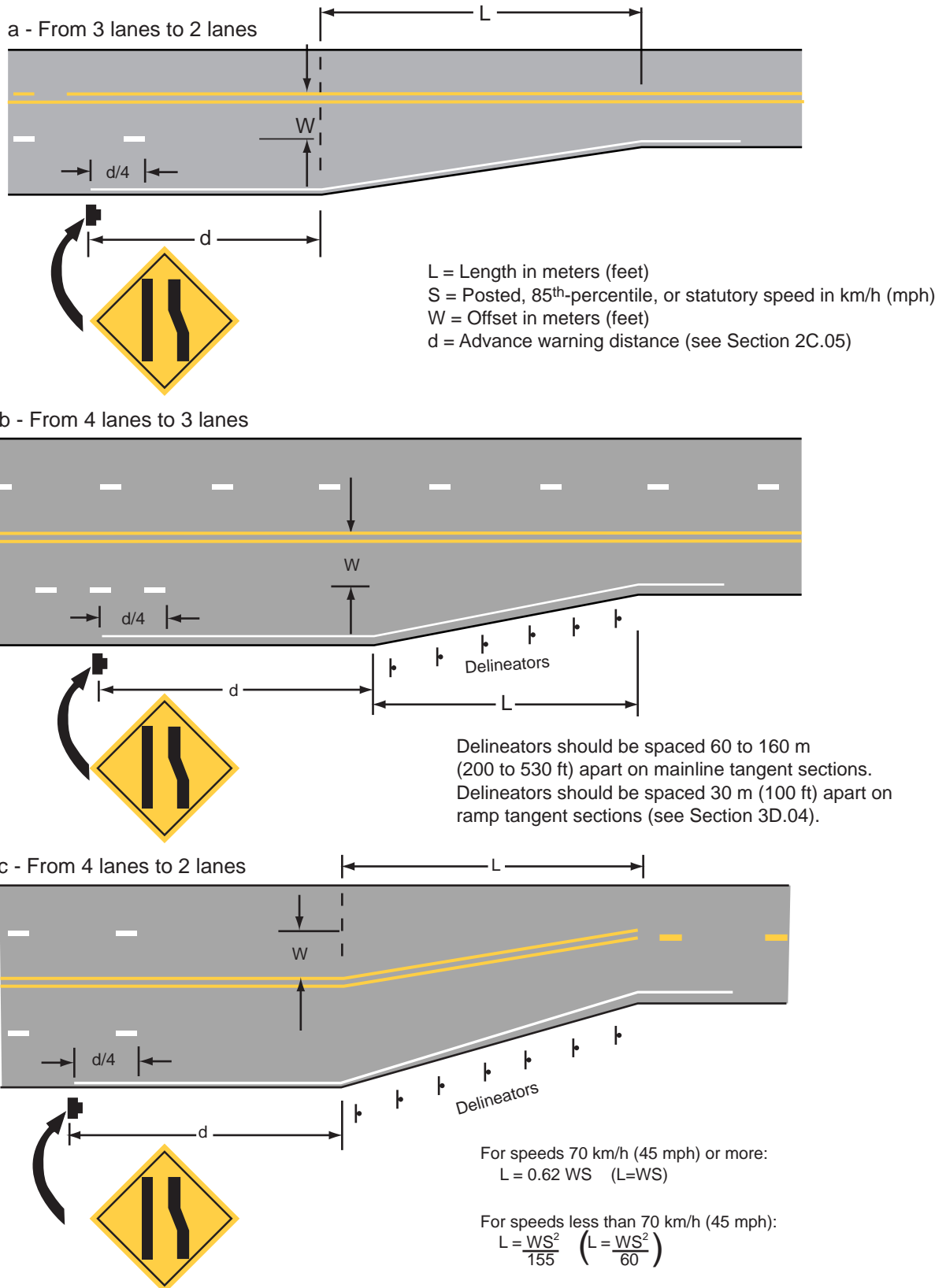

Figure 3B-12. Typical Lane Reduction Transition Markings



Option:

On new construction, where no posted or statutory speed limit is established, the design speed may be used in the transition taper length formula.

Guidance:

Lane line markings should be discontinued one-quarter of the distance between the Pavement Width Transition sign (see Section 2C.30) and the point where the transition taper begins.

Edge line markings should be installed from the location of the warning sign to beyond the beginning of the narrower roadway.

Support:

Pavement markings at lane reduction transitions supplement the standard signs.

Section 3B.10 Approach Markings for Obstructions**Standard:**

Pavement markings shall be used to guide traffic away from fixed obstructions within a paved roadway. Approach markings for bridge supports, refuge islands, median islands, and channelization islands shall consist of a diagonal line or lines extending from the centerline or the lane line to a point 0.3 to 0.6 m (1 to 2 ft) to the right side, or to both sides, of the approach end of the obstruction (see Sections 3B.01 and 3B.02).

Guidance:

For roadways having a posted or statutory speed limit of 70 km/h (45 mph) or greater, the taper length of the diagonal line markings should be computed by the formula $L = 0.62 WS$ for speeds in km/h ($L = WS$ for speeds in mph). For roadways where the posted or statutory speed limit is less than 70 km/h (45 mph), the formula $L = WS^2/155$ for speeds in km/h ($L = WS^2/60$ for speeds in mph) should be used to compute taper length. Under both formulas, L equals the taper length in meters (feet), W equals the width of the offset distance in meters (feet), and S equals the 85th-percentile speed or the posted or statutory speed limit, whichever is higher.

Standard:

The minimum taper length shall be 30 m (100 ft) in urban areas and 60 m (200 ft) in rural areas.

Support:

Typical approach markings for obstructions in the roadway are shown in Figure 3B-13.

Option:

Where observed speeds exceed posted or statutory speed limits, longer tapers may be used.

Standard:

If traffic is required to pass only to the right of the obstruction, the markings shall consist of a two-direction no-passing zone marking at least twice the length of the diagonal portion as determined by the appropriate taper formula (see Figure 3B-13).

Option:

If traffic is required to pass only to the right of the obstruction, yellow diagonal approach markings may be placed in the neutral area between the no-passing zone markings as shown in Figure 3B-13. Other markings, such as yellow delineators, raised pavement markers, and white crosswalk pavement markings, may also be placed in the neutral area.

Standard:

If traffic can pass either to the right or left of the obstruction, the markings shall consist of two channelizing lines diverging from the lane line, one to each side of the obstruction. In advance of the point of divergence, a wide white line or double white line shall be extended in place of the broken lane line for a distance equal to the length of the diverging lines (see Figure 3B-13).

Option:

If traffic can pass either to the right or left of the obstruction, additional white markings may be placed in the neutral area between the channelizing lines as shown in Figure 3B-13.

Section 3B.11 Raised Pavement Markers**Support:**

A raised pavement marker is a device with a height of at least 10 mm (0.4 in) mounted on or in a road surface that is intended to be used as a positioning guide or to supplement or substitute for pavement markings.

Figure 3B-13. Typical Markings for Obstructions in the Roadway

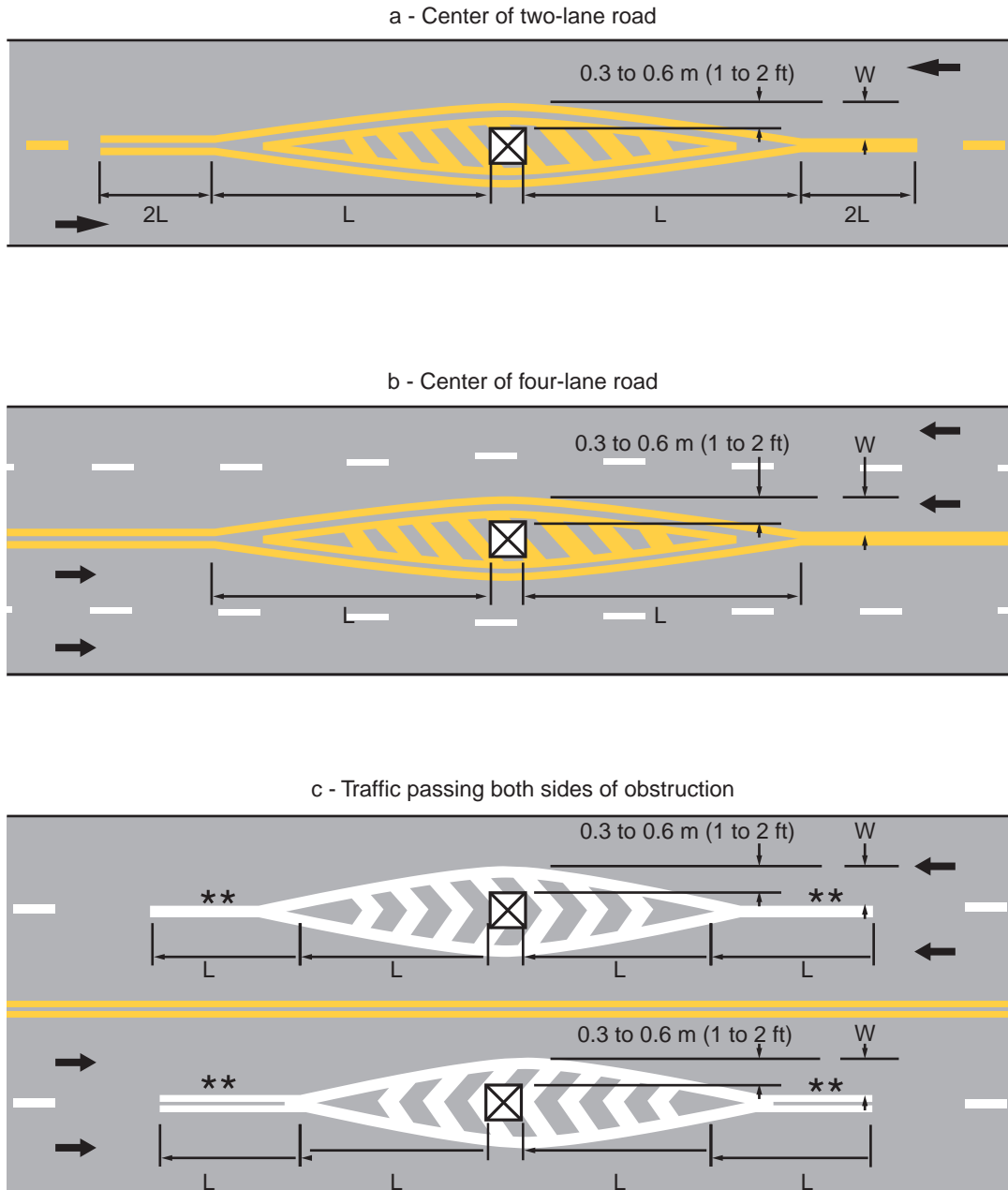

For speeds 70 km/h (45 mph) or more $L=0.62 WS$ ($L=WS$)
 For speeds less than 70 km/h (45 mph) $L = WS^2/155$ ($L=WS^2/60$)
 S = Posted, 85th-percentile, or statutory speed in km/h (mph)
 W = Offset distance in meters (ft)

Minimum length of : L = 30 m (100 ft) in urban areas
 L = 60 m (200 ft) in rural areas

Length "L" should be extended as required by sight distance conditions

Sect. 3B.11

Legend

- ➔ Direction of travel
- ** 200 mm (8 in) solid lane line marking; or double 100 mm (4 in) solid lane line markings

Standard:

The color of raised pavement markers under both daylight and nighttime conditions shall conform to the color of the marking for which they serve as a positioning guide, or for which they supplement or substitute.

Support:

Retroreflective and internally-illuminated raised pavement markers are available in mono-directional and bi-directional configurations. The bi-directional marker is capable of displaying the applicable color for each direction of travel.

Guidance:

Non-retroreflective raised pavement markers should not be used alone, without supplemental retroreflective or internally-illuminated markers, as a substitute for other types of pavement markings.

Directional configurations should be used to maximize correct information and to minimize confusing information provided to the road user. Directional configurations also should be used to avoid confusion resulting from visibility of markers that do not apply to the road user.

The spacing of raised pavement markers used to supplement or substitute for other types of longitudinal markings should correspond with the pattern of broken lines for which the markers supplement or substitute.

Section 3B.12 Raised Pavement Markers as Vehicle Positioning Guides with Other Longitudinal Markings

Option:

Raised pavement markers may be used as positioning guides with longitudinal line markings without necessarily conveying information to the road user about passing or lane-use restrictions. In such applications, markers may be positioned between the two lines of a one-way or two-way no-passing zone marking or positioned in line with or immediately adjacent to single solid or broken centerline or lane line markings.

Support:

A typical spacing for such applications is $2N$, where N equals the length of one line segment plus one gap (see Section 3A.06).

Option:

Where it is desired to alert the road user to changes in the travel path, such as on sharp curves or on transitions that reduce the number of lanes or that shift traffic laterally, the spacing may be reduced to N or less.

Section 3B.13 Raised Pavement Markers Supplementing Other Markings

Guidance:

The use of raised pavement markers for supplementing longitudinal line markings should conform to the following:

A. Lateral Positioning

1. When supplementing double line markings, pairs of raised pavement markers placed laterally in line with or immediately outside of the two lines should be used.
2. When supplementing wide line markings, pairs of raised pavement markers placed laterally adjacent to each other should be used.

B. Longitudinal Spacing

1. When supplementing solid line markings, raised pavement markers at a spacing no greater than N (see Section 3A.06) should be used, except when supplementing left edge line markings, a spacing no greater than $N/2$ should be used. Raised markers should not supplement right edge line markings.
2. When supplementing broken line markings, a spacing no greater than $2N$ should be used. However, when supplementing broken line markings identifying reversible lanes, a spacing no greater than N should be used.
3. When supplementing dotted line markings, a spacing appropriate for the application should be used.
4. When supplementing longitudinal line markings through at-grade intersections, one raised pavement marker for each short line segment should be used.
5. When supplementing edge line extensions through freeway interchanges, a spacing of $N/2$ should be used.

Option:

Raised pavement markers also may be used to supplement other markings for channelizing islands or approaches to obstructions.

Section 3B.14 Raised Pavement Markers Substituting for Pavement Markings

Option:

Retroreflective or internally-illuminated raised pavement markers, or non-retroreflective raised pavement markers supplemented by retroreflective or internally-illuminated markers, may be substituted for markings of other types.

Guidance:

If used, the pattern and color of the raised pavement markers should simulate the pattern and color of the markings for which they substitute.

The normal spacing of raised pavement markers, when substituting for other markings, should be determined in terms of the standard length of the broken line segment.

Option:

The side of a raised pavement marker that is visible to traffic proceeding in the wrong direction may be red.

Standard:

When raised pavement markers substitute for broken line markings, a group of four or five markers equally spaced at $N/12$ (see Section 3A.06), or at the one-third points of the line segment if N is other than 12 m (40 ft), with at least one retroreflective or internally-illuminated marker per group shall be used.

When raised pavement markers substitute for solid lane line markings, the markers shall be equally spaced at no greater than $N/8$, with retroreflective or internally-illuminated units at a spacing no greater than $N/2$.

Guidance:

Raised pavement markers should not substitute for right edge line markings.

Standard:

When raised pavement markers substitute for dotted lines, they shall be spaced at N/8, with not less than one raised pavement marker per dotted line. At least one raised marker every N shall be retroreflective or internally-illuminated.

Option:

When substituting for wide lines, raised pavement markers may be placed laterally adjacent to each other to simulate the width of the line.

Section 3B.15 Transverse Markings**Standard:**

Transverse markings, which include shoulder markings, word and symbol markings, stop lines, crosswalk lines, speed measurement markings, parking space markings and others, shall be white unless otherwise specified herein.

Guidance:

Because of the low approach angle at which pavement markings are viewed, transverse lines should be proportioned to provide visibility equal to that of longitudinal lines.

Pavement marking letters, numerals, and symbols shall be installed in accordance with the "Standard Alphabets for Highway Signs and Pavement Markings."

Section 3B.16 Stop and Yield Lines**Standard:**

If used, stop lines shall consist of solid white lines extending across approach lanes to indicate the point at which the stop is intended or required to be made.

If used, yield lines shall consist of a row of isosceles triangles pointing toward approaching vehicles extending across approach lanes to indicate the point at which the yield is intended or required to be made (see Figure 3B-14).

Guidance:

Stop lines should be 300 to 600 mm (12 to 24 in) wide.

Figure 3B-14. Typical Yield Line Layout for Streets and Highways

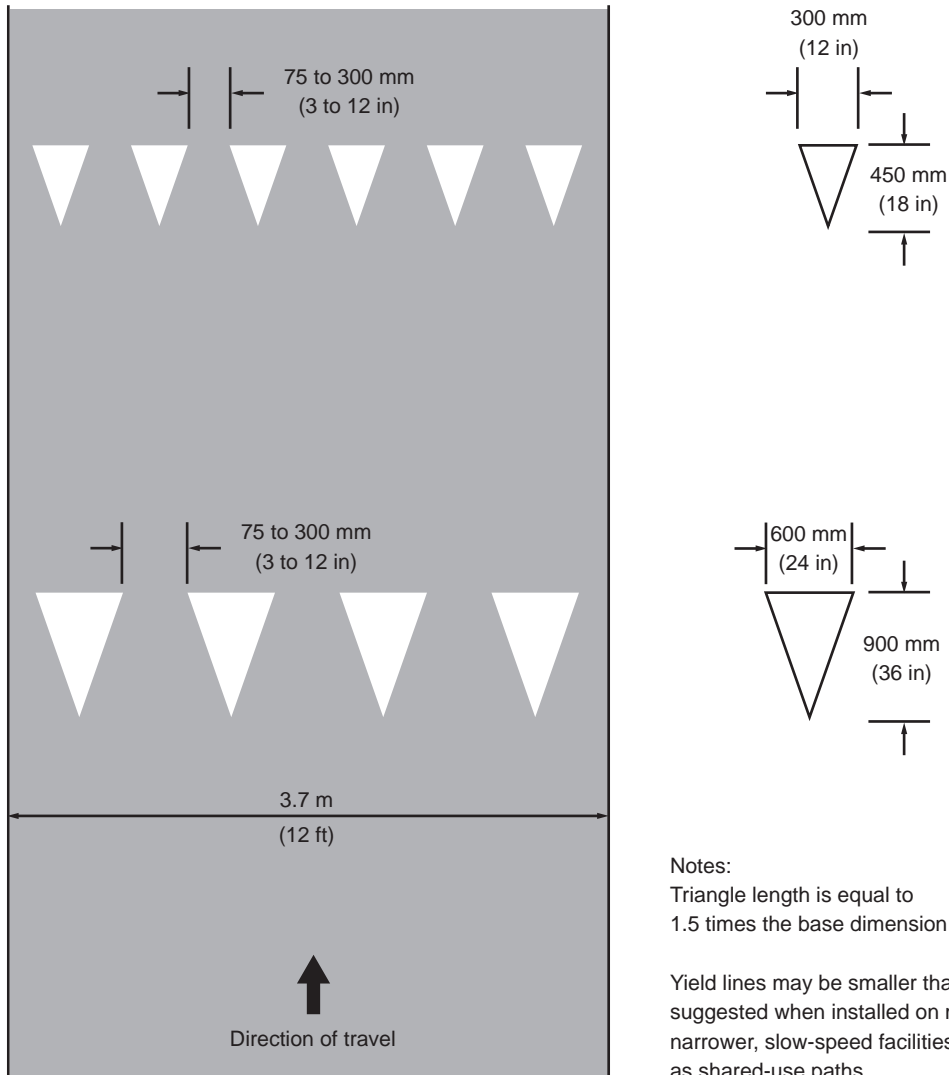

Notes:
Triangle length is equal to 1.5 times the base dimension

Yield lines may be smaller than suggested when installed on much narrower, slow-speed facilities such as shared-use paths

Stop lines should be used to indicate the point behind which vehicles are required to stop, in compliance with a STOP sign, traffic control signal, or some other traffic control device.

The individual triangles comprising the yield line should have a base of 0.3 to 0.6 m (12 to 24 in) wide and a height equal to 1.5 times the base. The space between the triangles should be 75 to 300 mm (3 to 12 in).

Option:

Yield lines may be used to indicate the point behind which vehicles are required to yield in compliance with a YIELD sign.

Guidance:

If used, stop and yield lines should be placed 1.2 m (4 ft) in advance of and parallel to the nearest crosswalk line, except at roundabouts as provided for in Section 3B.24. In the absence of a marked crosswalk, the stop line or yield line should be placed at the desired stopping or yielding point, but should be placed no more than 9 m (30 ft) nor less than 1.2 m (4 ft) from the nearest edge of the intersecting traveled way. Stop lines should be placed to allow sufficient sight distance for all approaches to an intersection.

Stop lines at mid-block signalized locations should be placed at least 12 m (40 ft) in advance of the nearest signal indication (see Section 4D.15).

Section 3B.17 Crosswalk Markings

Support:

Crosswalk markings provide guidance for pedestrians who are crossing roadways by defining and delineating paths on approaches to and within signalized intersections, and on approaches to other intersections where traffic stops.

Crosswalk markings also serve to alert road users of a pedestrian crossing point across roadways not controlled by traffic signals or STOP signs.

At non-intersection locations, crosswalk markings legally establish the crosswalk.

Standard:

When crosswalk lines are used, they shall consist of solid white lines that mark the crosswalk. They shall be not less than 150 mm (6 in) nor greater than 600 mm (24 in) in width.

Guidance:

Marked crosswalks should not be less than 1.8 m (6 ft) wide.

Crosswalk lines, if used on both sides of the crosswalk, should extend across the full width of pavement to discourage diagonal walking between crosswalks (see Figure 3B-15).

Crosswalks should be marked at all intersections where there is substantial conflict between vehicular and pedestrian movements.

Marked crosswalks also should be provided at other appropriate points of pedestrian concentration, such as at loading islands, midblock pedestrian crossings, or where pedestrians could not otherwise recognize the proper place to cross.

Crosswalk lines should not be used indiscriminately. An engineering study should be performed before they are installed at locations away from traffic signals or STOP signs.

Because non-intersection pedestrian crossings are generally unexpected by the road user, warning signs (see Section 2C.37) should be installed and adequate visibility should be provided by parking prohibitions.

Support:

Section 3B.16 contains information regarding placement of stop line markings near crosswalk markings.

Option:

For added visibility, the area of the crosswalk may be marked with white diagonal lines at a 45-degree angle to the line of the crosswalk or with white longitudinal lines parallel to traffic flow as shown in Figure 3B-15.

When diagonal or longitudinal lines are used to mark a crosswalk, the transverse crosswalk lines may be omitted. This type of marking may be used at locations where substantial numbers of pedestrians cross without any other traffic control device, at locations where physical conditions are such that added visibility of the crosswalk is desired, or at places where a pedestrian crosswalk might not be expected.

Guidance:

If used, the diagonal or longitudinal lines should be 300 to 600 mm (12 to 24 in) wide and spaced 300 to 600 mm (12 to 24 in) apart. The spacing design should avoid the wheel paths.

Figure 3B-15. Typical Types of Crosswalk Markings

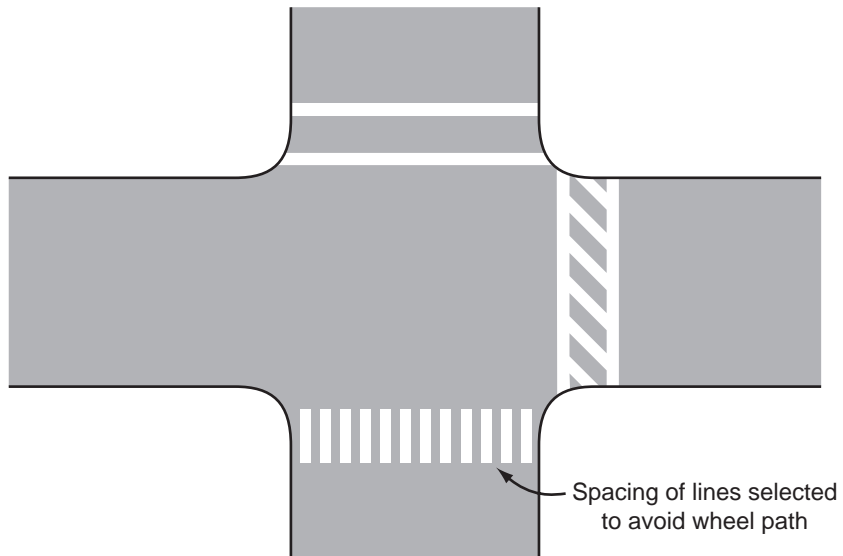
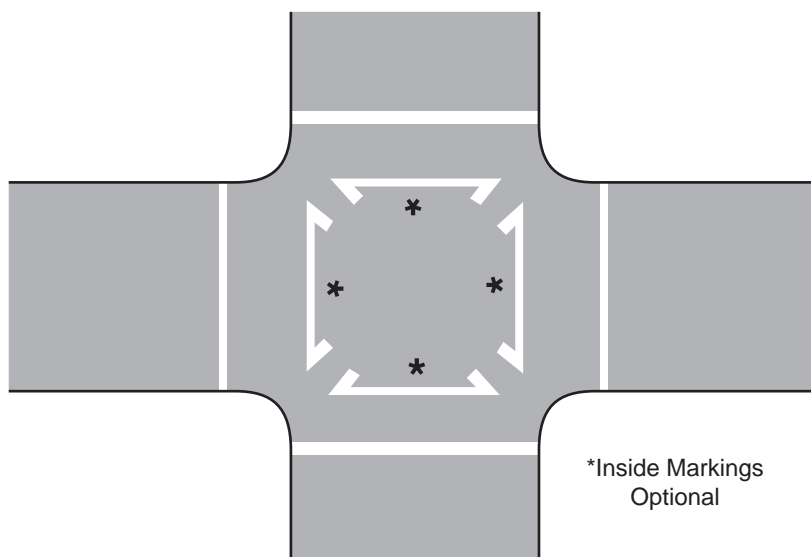

Figure 3B-16. Typical Crosswalk Markings for Exclusive Pedestrian Phase that Permits Diagonal Crossing



Option:

When an exclusive pedestrian phase that permits diagonal crossing is provided at a traffic control signal, a marking as shown in Figure 3B-16 may be used for the crosswalk.

Section 3B.18 Parking Space Markings

Support:

Marking of parking space boundaries encourages more orderly and efficient use of parking spaces where parking turnover is substantial. Parking space markings tend to prevent encroachment into fire hydrant zones, bus stops, loading zones, approaches to intersections, curb ramps, and clearance spaces for islands and other zones where parking is restricted. Typical parking space markings are shown in Figure 3B-17.

Standard:

Parking space markings shall be white.

Option:

Blue lines may supplement white parking space markings of each parking space designated for use only by persons with disabilities.

Support:

Additional parking space markings for the purpose of designating spaces for use only by persons with disabilities are discussed in Section 3B.19 and illustrated in Figure 3B-18.

Section 3B.19 Pavement Word and Symbol Markings

Support:

Word and symbol markings on the pavement are used for the purpose of guiding, warning, or regulating traffic. Symbol messages are preferable to word messages. Examples of standard word and arrow pavement markings are shown in Figures 3B-19 and 3B-20.

Standard:

Word and symbol markings shall be white, except as otherwise noted in this Section.

Guidance:

Letters and numerals should be 1.8 m (6 ft) or more in height.

Figure 3B-17. Typical Parking Space Markings

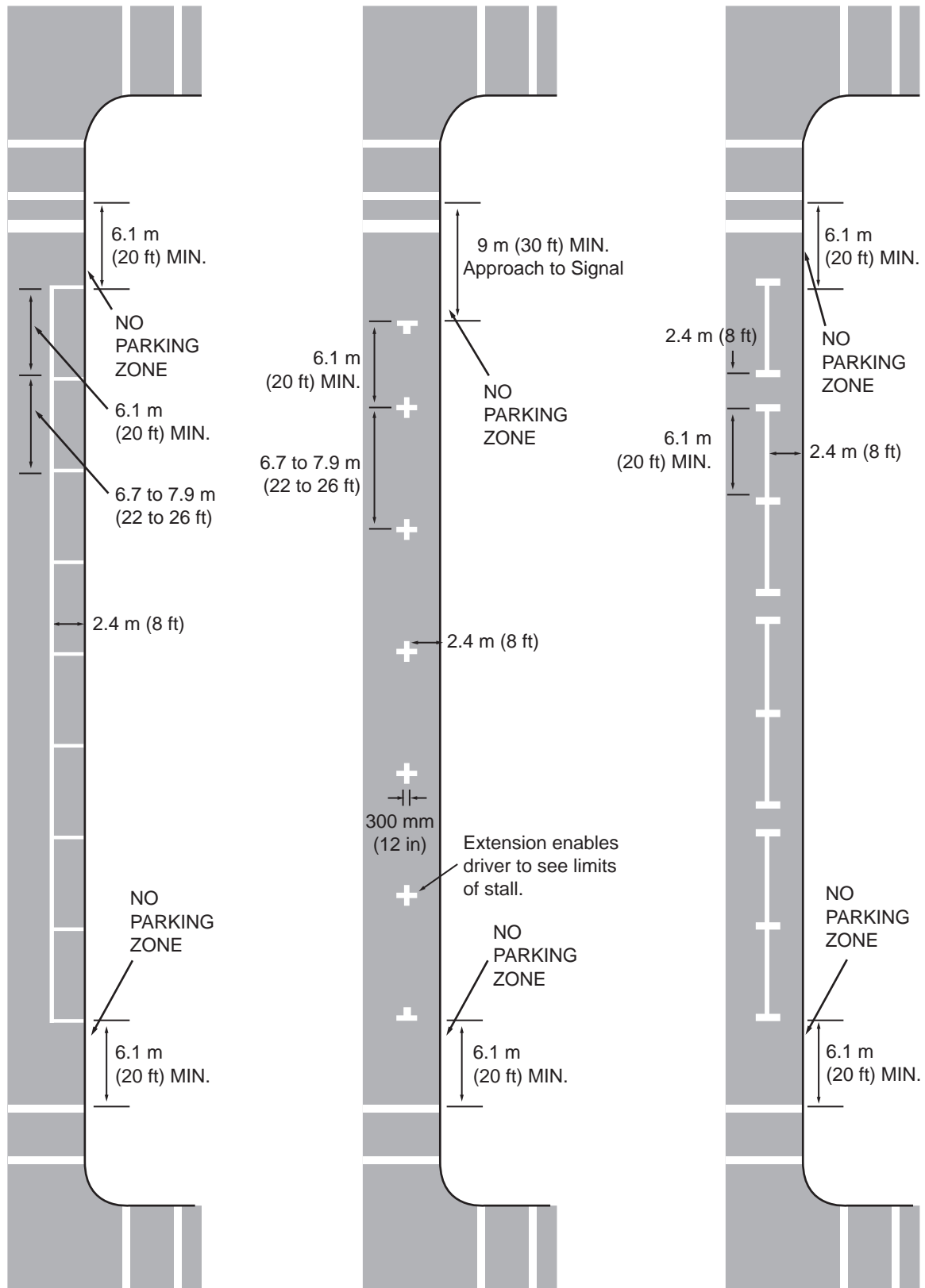

Figure 3B-18. International Symbol of Accessibility Parking Space Marking with Blue Background and White Border Options

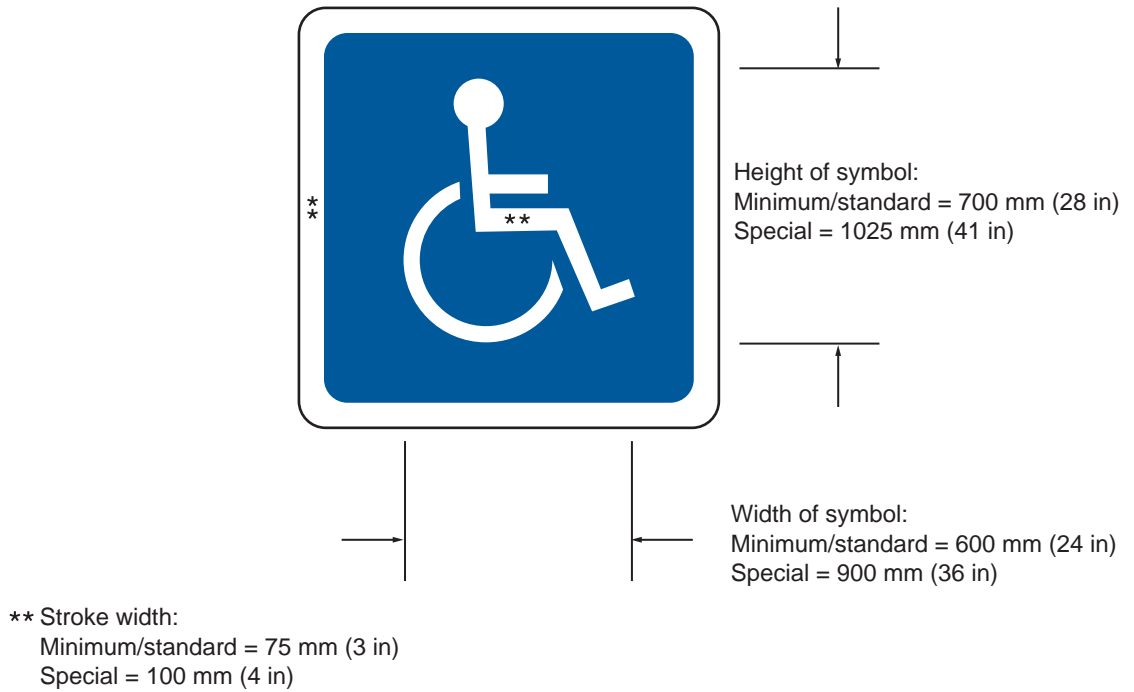
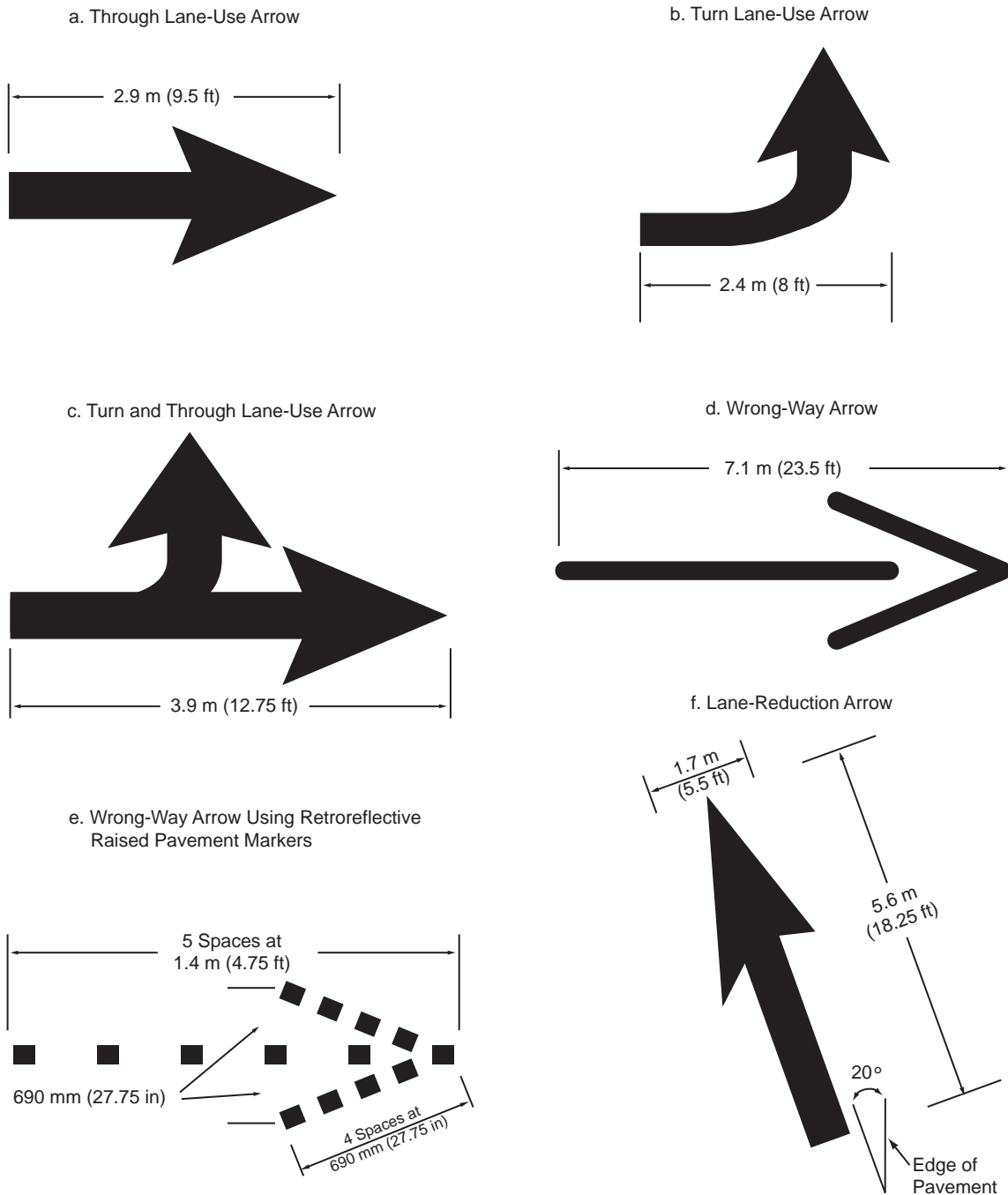

Figure 3B-19. Typical Elongated Letters for Word Pavement Markings



Figure 3B-20. Typical Lane-Use, Lane-Reduction, and Wrong-Way Arrows for Pavement Markings



Typical sizes for normal installation; smaller sizes may be reduced approximately one-third for low-speed urban conditions; larger sizes may be needed for freeways, above average speeds, and other critical locations. A narrow elongated arrow design is optional. For proper proportion, see "Typical Alphabets for Highway Signs and Pavement Markings" (Available from FHWA, 400 Seventh St., SW., HOTO-1, Washington, DC. 20590)

Word and symbol markings should not exceed three lines of information.

If a pavement marking word message consists of more than one line of information, it should read in the direction of travel. The first word of the message should be nearest to the road user.

The longitudinal space between word or symbol message markings, including arrow markings, should be at least four times the height of the characters for low-speed roads, but not more than ten times the height of the characters under any conditions.

The number of different word and symbol markings used should be minimized to provide effective guidance and avoid misunderstanding.

Except as noted in the Option below, pavement word and symbol markings should be no more than one lane in width.

Option:

The SCHOOL word marking may extend to the width of two lanes (see Section 7C.06).

Guidance:

When the SCHOOL word marking is extended to the width of two approach lanes, the characters should be ten feet or more in height (see Section 7C.06).

Pavement word and symbol markings should be proportionally scaled to fit within the width of the facility upon which they are applied.

Option:

On narrow, low-speed bicycle paths, the pavement words and symbols may be smaller than suggested, but to the relative scale.

The International Symbol of Accessibility parking space markings may be placed in each parking space designated for use by persons with disabilities. A blue background with white border may supplement the wheelchair symbol as shown in Figure 3B-18.

Standard:

Where through traffic lanes approaching an intersection become mandatory turn lanes, lane-use arrow markings (see Figure 3B-20) shall be used and shall be accompanied by standard signs.

Lane use, lane reduction, and wrong-way arrow markings shall be designed as shown in Figure 3B-20.

Guidance:

Where through lanes become mandatory turn lanes, signs or markings should be repeated as necessary to prevent entrapment and to help the road user select the appropriate lane in advance of reaching a queue of waiting vehicles.

Option:

Lane-use arrow markings (see Figure 3B-20) may be used to convey either guidance or mandatory messages.

The ONLY word marking (see Figure 3B-19) may be used to supplement lane-use arrow markings (see Figure 3B-21).

In situations where a lane reduction transition occurs, the lane reduction arrow markings shown in Figure 3B-20 may be used.

Guidance:

Where crossroad channelization or ramp geometrics do not make wrong-way movements difficult, a lane-use arrow should be placed in each lane of an exit ramp near the crossroad terminal where it will be clearly visible to a potential wrong-way road user (see Figure 3B-22).

Option:

The wrong-way arrow markings shown in Figure 3B-20 may be placed near the downstream terminus of a ramp as shown in Figures 3B-22 and 3B-23 to indicate the correct direction of traffic flow and to discourage drivers from traveling in the wrong direction.

A yield-ahead triangle symbol or YIELD AHEAD word pavement marking may be used on approaches to intersections where the approaching traffic will encounter a YIELD sign at the intersection (see Figure 3B-24).

Support:

Lane-use arrow markings are often used to provide guidance in turn bays (see Figure 3B-21), where turns may or may not be mandatory, and in two-way left-turn lanes (see Figure 3B-7).

Option:

Word and symbol markings may include, but are not limited to, the following. Other words or symbols may also be used under certain conditions.

A. Regulatory:**1. STOP**

Figure 3B-21. Typical Lane Use Control Word and Symbol Markings

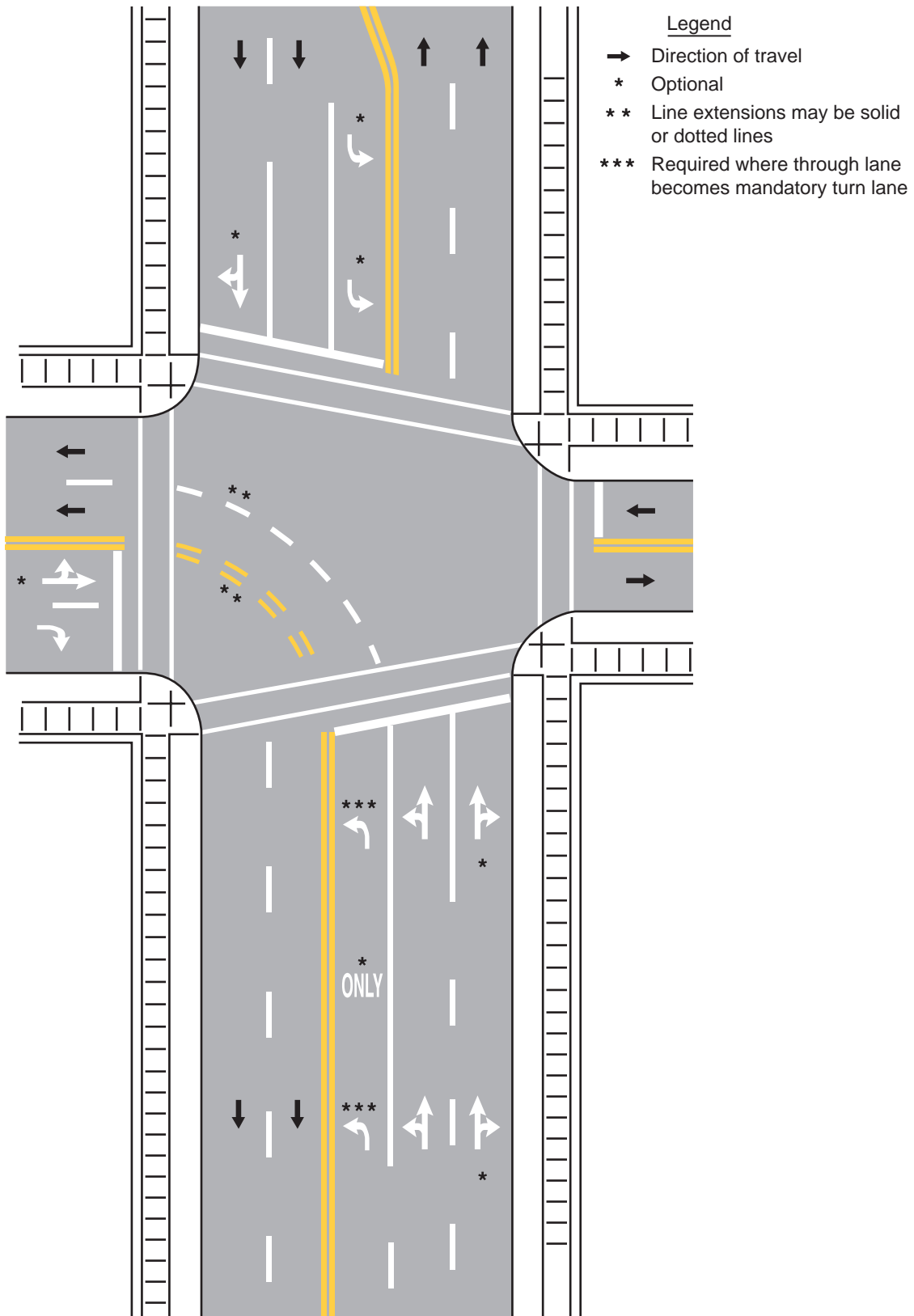

Figure 3B-23. Typical Arrow Markings at Entrance Ramp Terminals Where Design Does Not Clearly Indicate the Direction of Flow

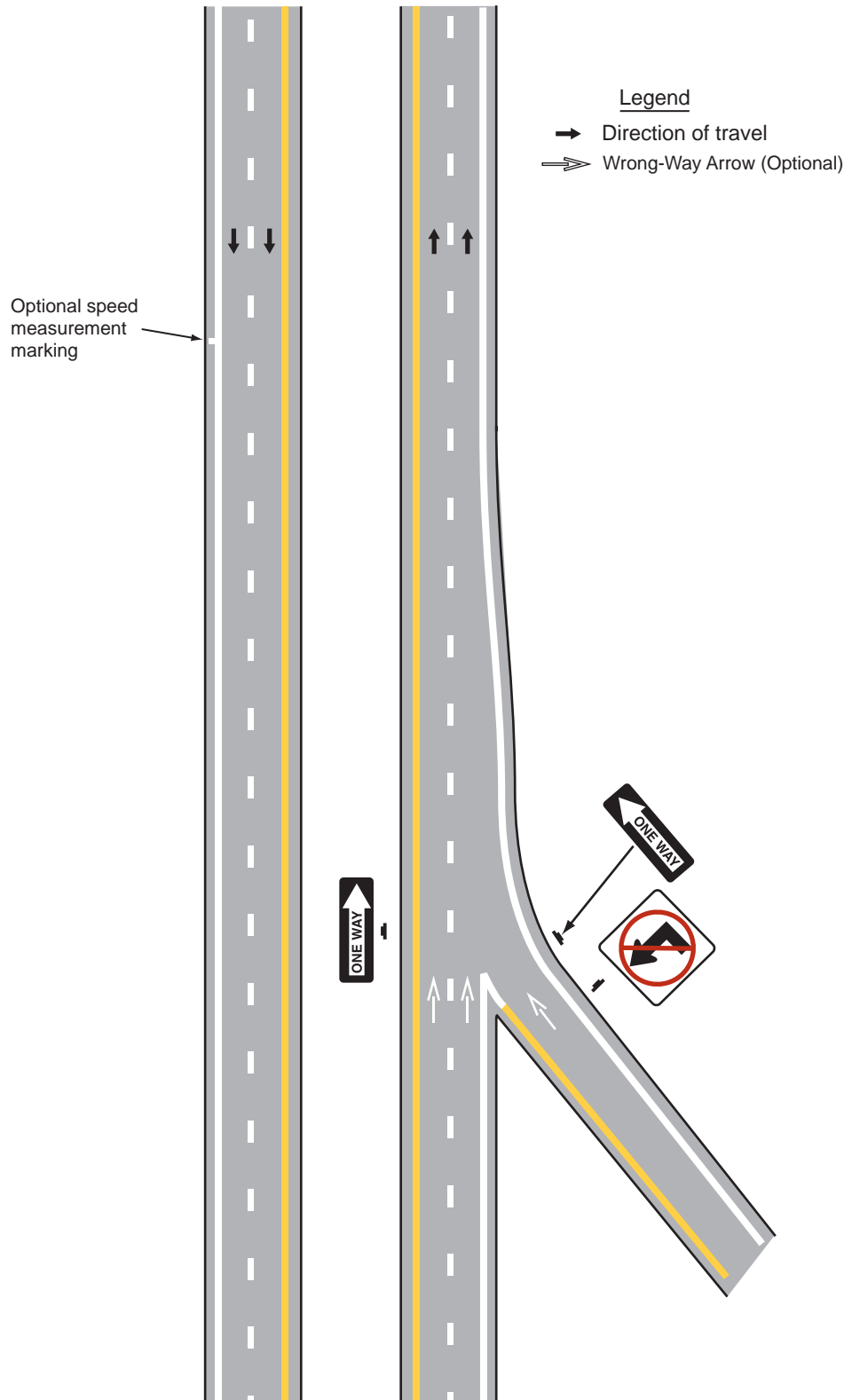
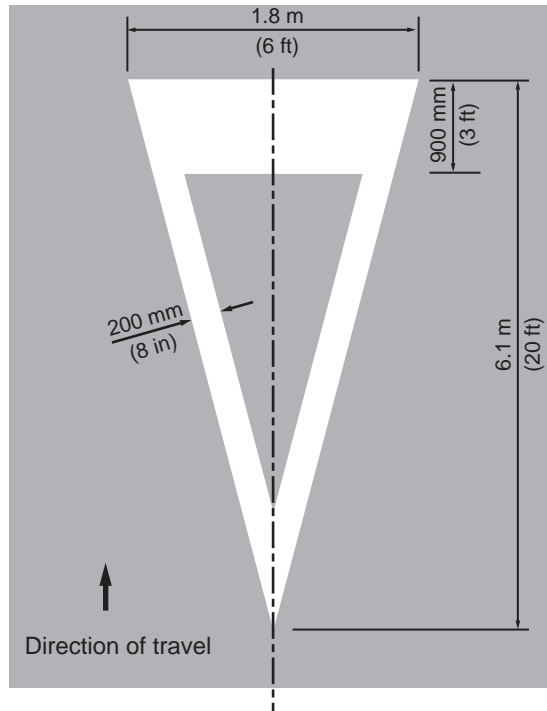
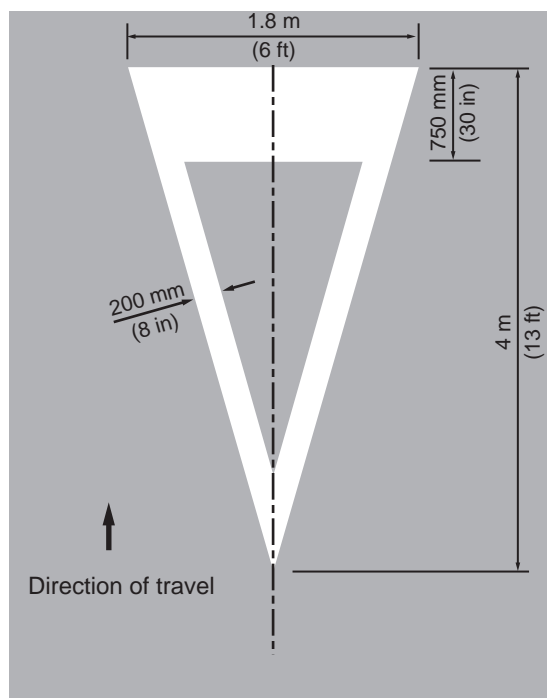

Figure 3B-24. Typical Yield Ahead Triangle Symbols for Streets and Highways

Posted or Statutory Speed Limit 70 km/h (45 mph) or greater



Posted or Statutory Speed Limit less than 70 km/h (45 mph)



2. RIGHT (LEFT) TURN ONLY

3. 40 km/h (25 MPH)

4. Arrow Symbols

B. Warning:

1. STOP AHEAD

2. YIELD AHEAD

3. YIELD AHEAD Triangle Symbol

4. SCHOOL X-ING

5. SIGNAL AHEAD

6. PED X-ING

7. SCHOOL

8. R X R

9. BUMP

10. HUMP

C. Guide:

1. US 40

2. STATE 135

3. ROUTE 40

Standard:

The word STOP shall not be used on the pavement unless accompanied by a stop line (see Section 3B.16) and STOP sign (see Section 2B.04).

The word STOP shall not be placed on the pavement in advance of a stop line, unless every vehicle is required to stop at all times.

The yield-ahead triangle symbol or YIELD AHEAD word pavement marking shall not be used unless a YIELD sign (see Section 2B.08) is in place at the intersection. The yield-ahead symbol marking shall be as shown in Figure 3B-24.

Section 3B.20 Speed Measurement Markings

Support:

A speed measurement marking is a transverse marking placed on the roadway to assist the enforcement of speed regulations.

Standard:

Speed measurement markings, if used, shall be white, and shall not be greater than 600 mm (24 in) in width.

Option:

Speed measurement markings may extend 600 mm (2 ft) on either side of the centerline or 600 mm (2 ft) on either side of edge line markings at 0.4 km (1/4 mi) intervals over a 1.6 km (1 mi) length of roadway. When paved shoulders of sufficient width are available, the speed measurements markings may be placed entirely on these shoulders. Advisory signs may be used in conjunction with these markings (see Figure 3B-10).

Section 3B.21 Curb Markings

Support:

Curb markings are most often used to indicate parking regulations or to delineate the curb.

Standard:

Signs shall be used with curb markings in those areas where curb markings are frequently obliterated by snow and ice accumulation.

Where curbs are marked, the colors shall conform to the general principles of markings (see Section 3A.05).

Guidance:

When curb markings are used without signs to convey parking regulations, a legible word marking regarding the regulation (such as "No Parking" or "No Standing") should be placed on the curb.

Retroreflective solid yellow markings should be placed on the noses of raised medians and curbs of islands that are located in the line of traffic flow where the curb serves to channel traffic to the right of the obstruction.

Retroreflective solid white markings should be used when traffic may pass on either side of the island.

Option:

Local highway agencies may prescribe special colors for curb markings to supplement standard signs for parking regulation.

Support:

Since yellow and white curb markings are frequently used for curb delineation and visibility, it is advisable to establish parking regulations through the installation of standard signs (see Sections 2B.34 through 2B.36).

Where the curbs of the islands become parallel to the direction of traffic flow, it is not necessary to mark the curbs unless an engineering study indicates the need for this type of delineation.

Curbs at openings in a continuous median island need not be marked unless an engineering study indicates the need for this type of marking.

Section 3B.22 Preferential Lane Word and Symbol Markings**Standard:**

When a lane is assigned full or part time to a particular class or classes of vehicles, preferential lane markings shall be used.

Signs or signals shall be used with preferential lane word or symbol markings.

All preferential lane word and symbol markings shall be white.

All preferential lane word and symbol markings shall be positioned laterally in the center of the preferred-use lane.

Support:

Preferential lanes may be designated to identify a wide variety of special uses. This could include, but is not limited to, high-occupancy vehicle (HOV) lanes, bicycle lanes, bus only lanes, and taxi only lanes.

Standard:

Where a preferential lane use is established, the preferential lane shall be marked with one of the following symbol or word markings for the preferential lane use specified:

- A. HOV lane - the preferential lane use marking for high-occupancy vehicle lanes shall consist of white lines formed in a diamond shape. The diamond**

shall be at least 0.75 m (2.5 ft) wide and 3.7 m (12 ft) in length. The lines shall be at least 150 mm (6 in) in width.

- B. Bicycle lane - the preferential lane use marking for a bicycle lane shall consist of a bicycle symbol or the word marking BIKE LANE (see Chapter 9C and Figures 9C-1 and 9C-3 through 9C-6).**
- C. Bus Only Lane - the preferential lane use marking for a bus only lane shall consist of the word marking BUS ONLY.**
- D. Taxi Only Lane - the preferential lane use marking for a taxi only lane shall consist of the word marking TAXI ONLY.**
- E. Other preferential lane use markings shall be identified in accordance with Section 3B.23.**

Guidance:

Engineering judgment should determine the need for supplemental devices such as tubular markers, traffic cones, or flashing lights.

Support:

The spacing of the markings is an engineering judgment that is based on the prevailing speed, block lengths, distance from intersections, and other factors that affect clear communication to the road user. Markings spaced as close as 24 m (80 ft) apart might be appropriate on city streets, while markings spaced 300 m (1,000 ft) might be appropriate for freeways.

Option:

The vehicle occupancy requirements established for a high-occupancy vehicle lane may be included in sequence after the diamond symbol. The word message HOV may be used instead of the diamond symbol.

Section 3B.23 Preferential Lane Longitudinal Markings for Motorized Vehicles

Standard:

Preferential lane longitudinal markings for motorized vehicles shall be marked with the appropriate word or symbol pavement markings in accordance with Section 3B.22.

Support:

Preferential lanes can take many forms depending on the level of usage and the design of the facility. They might be physically separated from the other travel lanes by a barrier, median, or painted neutral area, or they might be concurrent with other travel lanes and be separated only by longitudinal pavement markings. Further, physically-separated preferential lanes might operate in the same direction or be reversible.

Option:

Preferential lanes may be operated either full-time (24 hours per day on all days), for extended periods of the day, or part-time (restricted usage during specific hours on specified days).

Standard:

The following four sections are presented in tabular form in Table 3B-2:

- A. Physically-separated, non-reversible preferential lane - the longitudinal pavement markings for preferential lanes that are physically separated from the other travel lanes by a barrier, median, or painted neutral area shall consist of a single normal solid yellow line at the left edge of the travel lane(s), a single normal solid white line at the right edge of the travel lane(s), and if there are two or more preferential lanes, the preferential travel lanes shall be separated with a normal broken white line (see Figure 3B-25a).**
- B. Physically-separated, reversible preferential lane - the longitudinal pavement markings for reversible preferential lanes that are physically separated from the other travel lanes by a barrier, median, or painted neutral area shall consist of a single normal solid white line at both edges of the travel lane(s), and if there are two or more preferential lane, the preferential travel lanes shall be separated with a normal broken white line (see Figure 3B-25a).**
- C. Concurrent flow (left side) preferential lane - the longitudinal pavement markings for a full-time or part-time preferential lane on the left side of the other traveled lanes shall consist of a single normal solid yellow line at the left edge of the preferential travel lane(s) and one of the following at the right edge of the preferential travel lane(s):**
 - 1. A double solid wide white line where crossing is prohibited (see Figure 3B-25b).**
 - 2. A single solid wide white line where crossing is discouraged (see Figure 3B-25c).**
 - 3. A single broken wide white line where crossing is permitted (see Figure 3B-25d).**

Table 3B-2. Standard Edge Line Lane Markings for Preferential Lanes

Type of Preferential Lane	Left Edge Line	Right Edge Line
Physically-Separated, Non-Reversible	A single normal solid yellow line	A single normal solid white line
Physically Separated, Reversible	A single normal solid white line	A single normal solid white line
Concurrent Flow-Left Side	A single normal solid yellow line	A double solid wide white line where crossing is prohibited (see Figure 3B-25b) A single solid wide white line where crossing is discouraged (see Figure 3B-25c) A single broken wide white line where crossing is permitted (see Figure 3B-25d)
Concurrent Flow-Right Side	A double solid wide white line where crossing is prohibited (see Figure 3B-25b) A single solid wide white line where crossing is discouraged (see Figure 3B-25c) A single broken wide white line where crossing is permitted (see Figure 3B-25d) A single dotted normal white line where crossing is permitted for any vehicle to perform a right-turn maneuver (see Figure 3B-25e)	A single normal solid white line

Notes: If there are two or more preferential lanes, they shall be separated with a normal broken white line.
 The standard lane markings listed in this table are provided in a tabular format for reference.
 This information is also described in the second Standard in Section 3B.23.

Figure 3B-25. Typical Markings for Preferential Lanes for Motorized Vehicles (Sheet 1 of 2)

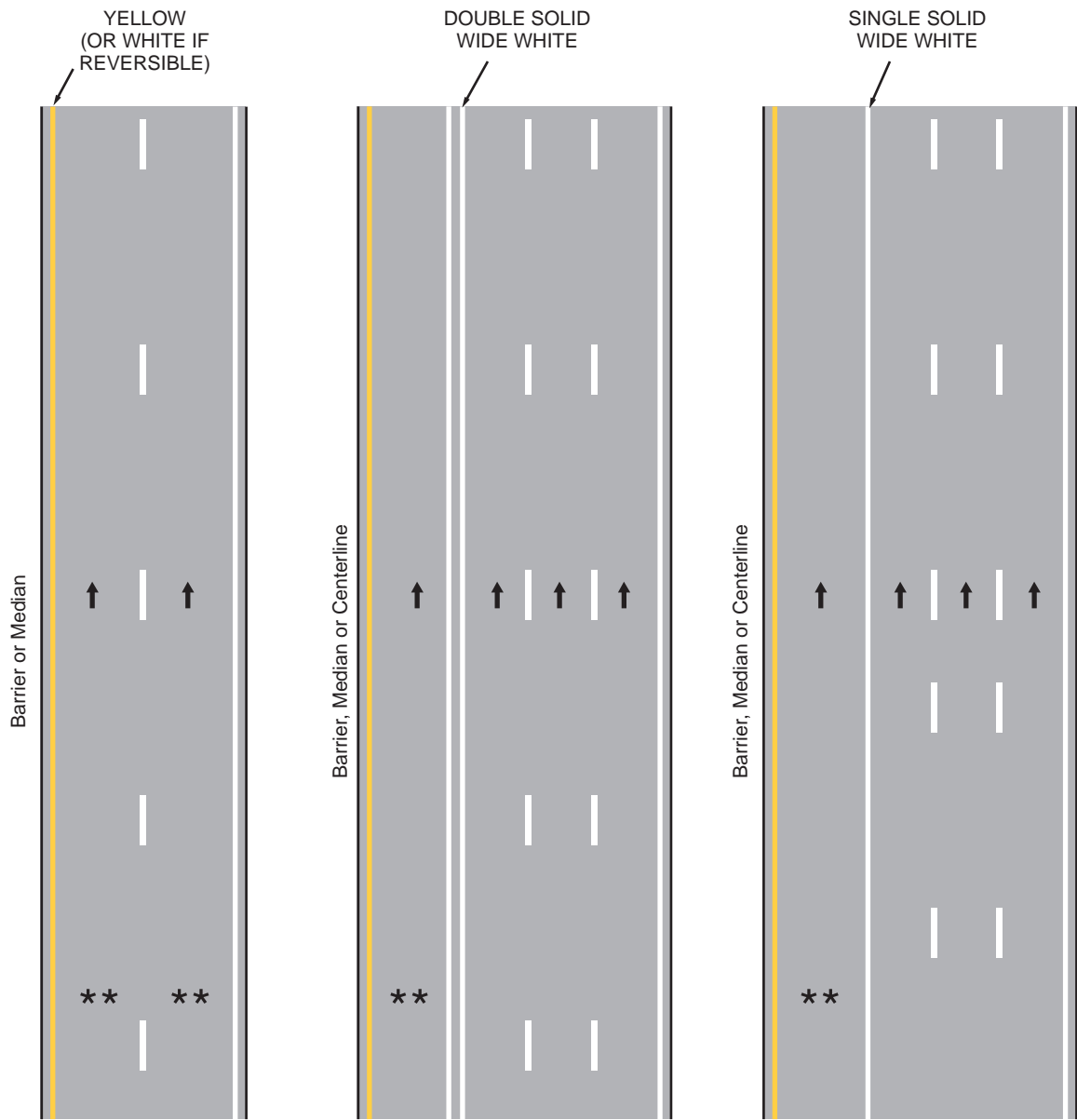

a - Physically separated permanent lane(s)

b - Full-time concurrent lane(s) where enter/exit movements are PROHIBITED

c - Concurrent lane(s) where enter/exit movements are DISCOURAGED

Legend

- ➔ Direction of travel
- ** Applicable symbol or word

Figure 3B-25. Typical Markings for Preferential Lanes for Motorized Vehicles (Sheet 2 of 2)

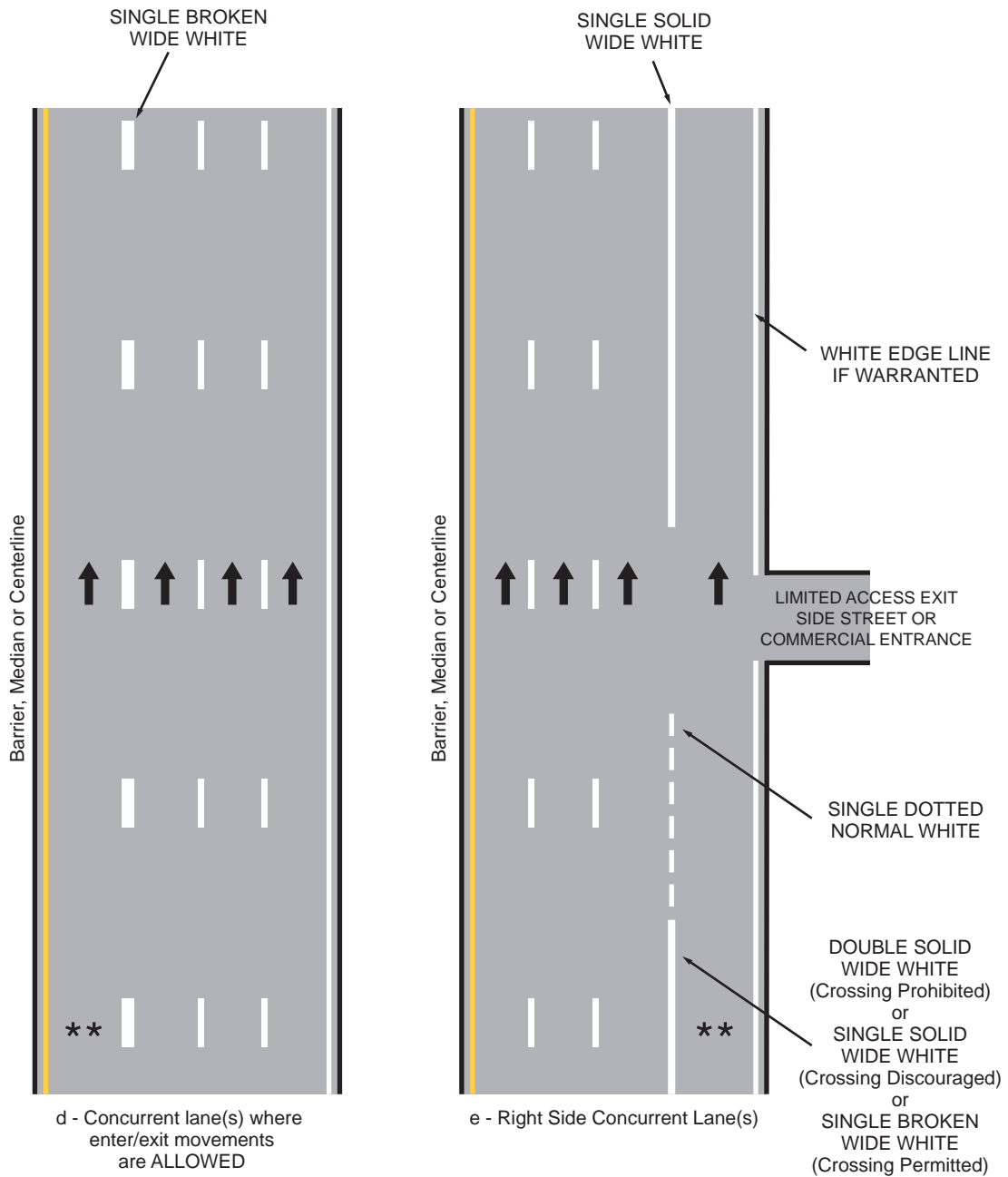

Legend

- ➔ Direction of travel
- ** Applicable symbol or word

If there are two or more preferential lanes, the preferential travel lanes shall be separated with a normal broken white line.

D. Concurrent flow (right side) preferential lane - the longitudinal pavement markings for a full-time or part-time preferential lane on the right of the other travel lanes shall consist of a single normal solid white line at the right edge of the preferential travel lane(s) if warranted and one of the following at the left edge of the preferential travel lane(s):

- 1. A double solid wide white line where crossing is prohibited (see Figure 3B-25b).**
- 2. A single solid wide white line where crossing is discouraged (see Figure 3B-25c).**
- 3. A single broken wide white line where crossing is permitted (see Figure 3B-25d).**
- 4. A single dotted normal white line where crossing is permitted for any vehicle to perform a right turn maneuver (see Figure 3B-25e).**

If there are two or more preferential lanes, the preferential travel lanes shall be separated with a normal broken white line.

Guidance:

When concurrent flow preferential lanes and other travel lanes are separated by more than 1.2 m (4 ft), chevron markings should be placed in the neutral area. The chevron spacing should be 30 m (100 ft) or greater.

Option:

For full-time or part-time concurrent flow preferential lanes, the spacing or skip pattern of the single broken wide white line may be reduced. The width of the single broken wide white line may be increased.

Section 3B.24 Markings for Roundabouts

Support:

Roundabouts are distinctive circular roadways that have the following three critical characteristics:

- A. A requirement to yield at entry which gives a vehicle on the circular roadway the right-of-way; and**

- B. A deflection of the approaching vehicle around the central island; and
- C. A flare or widening of the approach to match the width of the circular roadway.

Typical markings for roundabouts are shown in Figures 3B-26 and 3B-27.

Option:

A yellow edge line may be placed around the inner (left) edge of the circular roadway.

Guidance:

A white line should be used on the outer (right) side of the circular roadway as follows: a solid line along the splitter island and a dotted line across the lane(s) entering the roundabout.

Edge line extensions should not be placed across the exits from the circular roadway.

Where crosswalk markings are used, these markings should be located a minimum of 7.6 m (25 ft) upstream for the yield line, or, if none, from the dotted white line.

Option:

Lane lines may be used on the circular roadway if there is more than one lane.

Section 3B.25 Markings for Other Circular Intersections

Support:

Other circular intersections include but are not limited to rotaries, traffic circles, and residential traffic calming designs.

Option:

The markings shown in Figures 3B-26 and 3B-27 may be used at other circular intersections when engineering judgment indicates that their presence will benefit drivers or pedestrians.

Section 3B.26 Speed Hump Markings

Standard:

If used, speed hump markings shall be a series of white markings placed on a speed hump to identify its location.

Figure 3B-26. Typical Markings for Roundabouts with One Lane

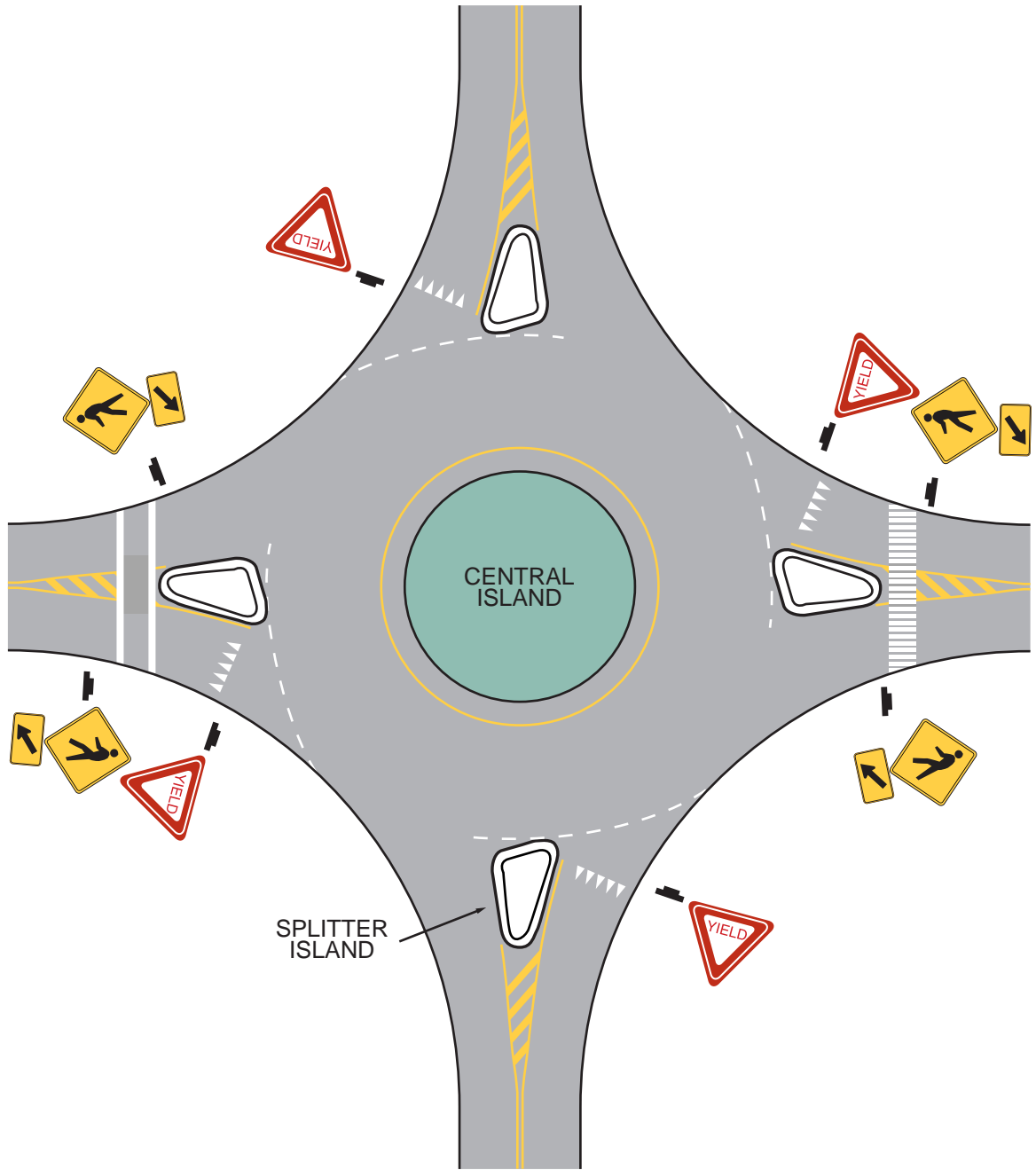
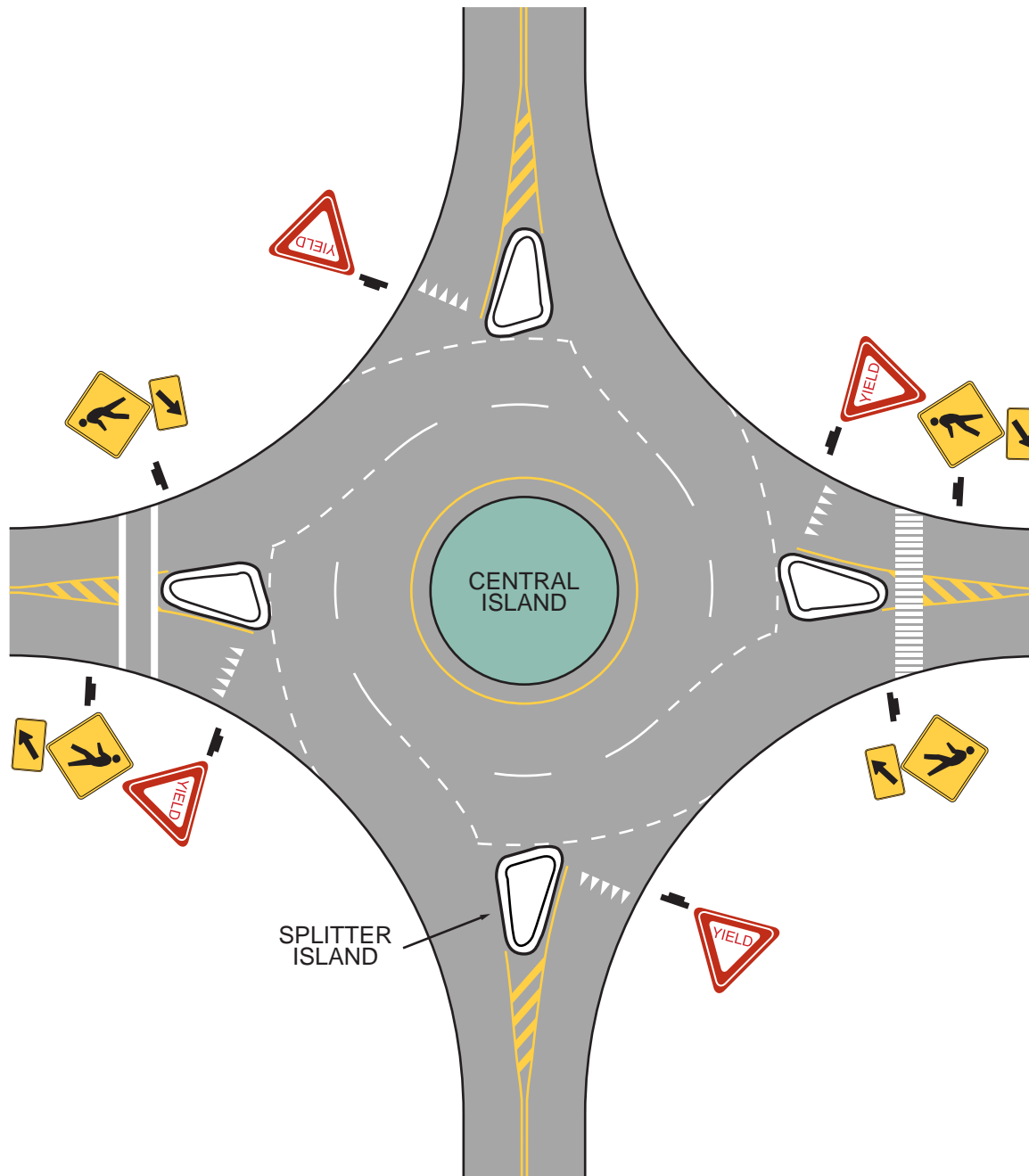

Figure 3B-27. Typical Markings for Roundabouts with Two Lanes



Option:

Speed humps, except those used for crosswalks, may be marked in accordance with Figure 3B-28. The markings shown in Figure 3B-29 may be used where the speed hump also functions as a crosswalk or speed table.

Section 3B.27 Advance Speed Hump Markings**Standard:**

If used, advance speed hump markings shall be a special white marking placed in advance of speed humps or other engineered vertical roadway deflections such as dips.

Option:

Advance speed hump markings may be used in advance of an engineered vertical roadway deflection where added visibility is desired or where such deflection is not expected (see Figure 3B-30).

Advance pavement wording such as BUMP or HUMP (see Section 3B.19) may be used on the approach to a speed hump either alone or in conjunction with advance speed hump markings. Appropriate advance warning signs may be used in conformance with Section 2C.22.

Guidance:

If used, advance speed hump markings should be installed in each approach lane.

Figure 3B-28. Typical Pavement Markings for Speed Humps

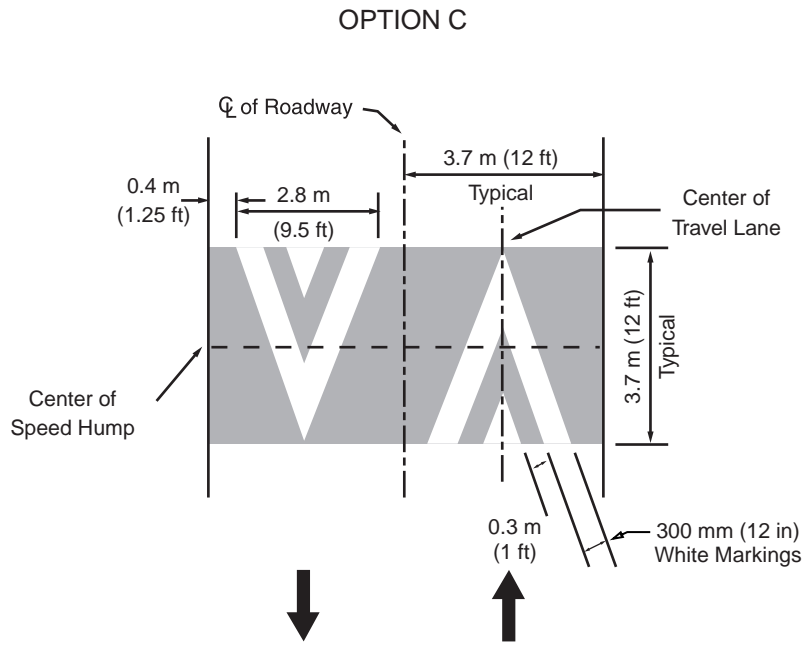
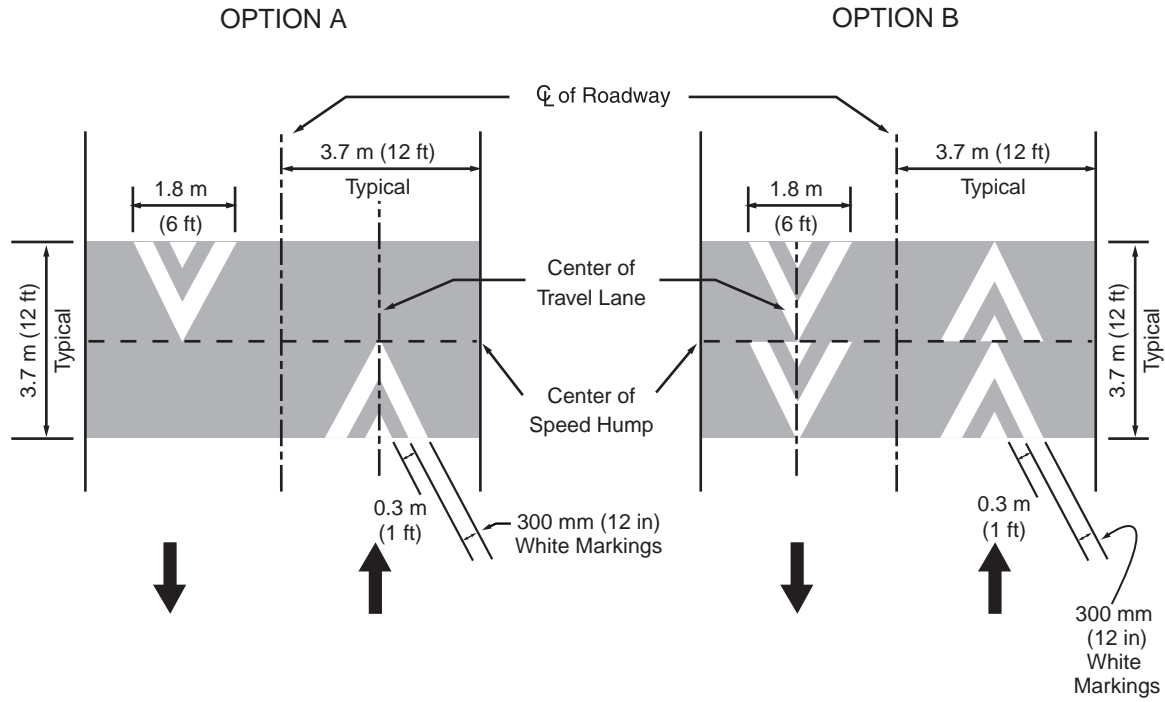

Legend
 → Direction of travel

Figure 3B-29. Typical Pavement Markings for Speed Tables or Speed Humps with Crosswalks

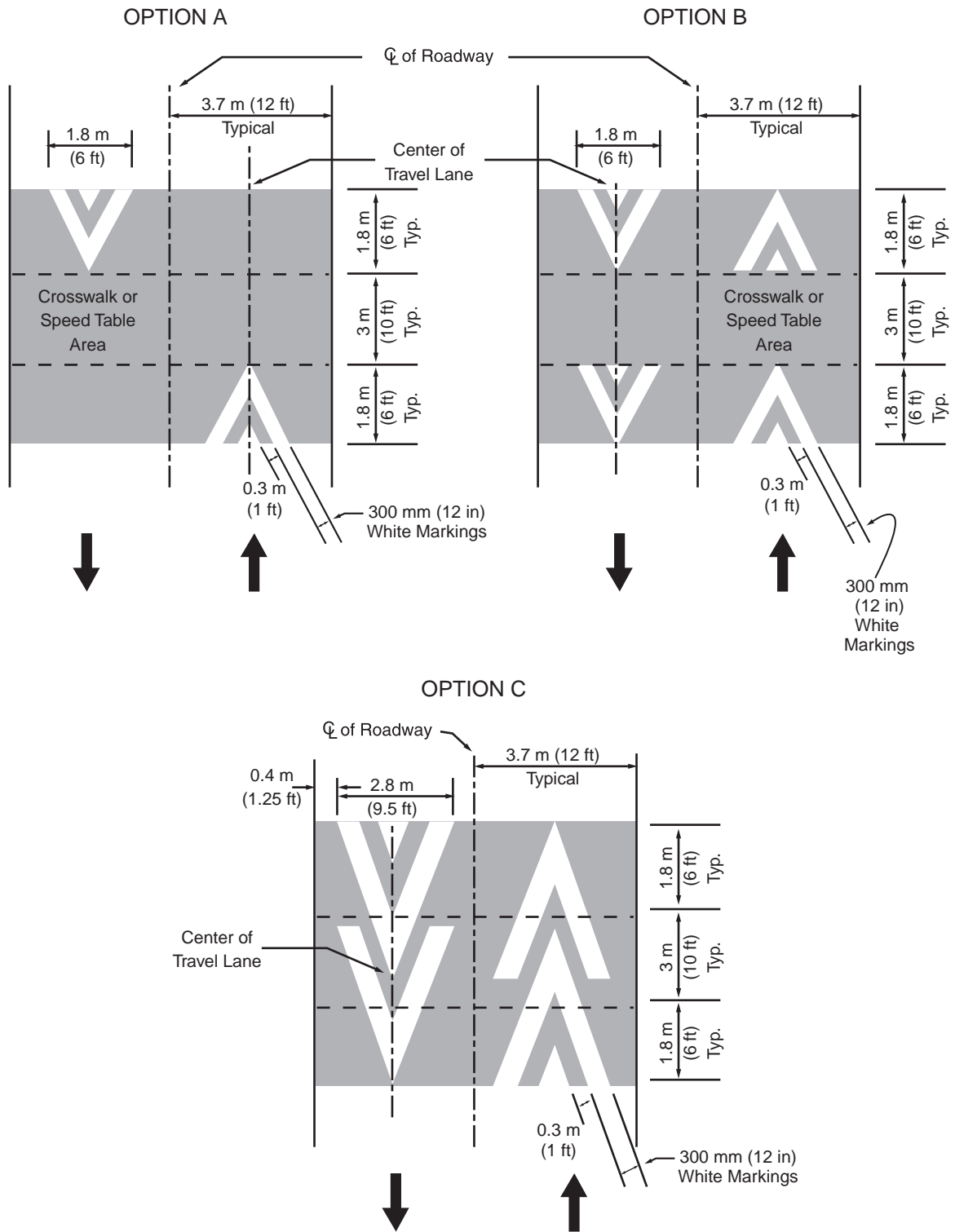

Legend

➔ Direction of travel

Figure 3B-30. Typical Advance Warning Markings for Speed Humps

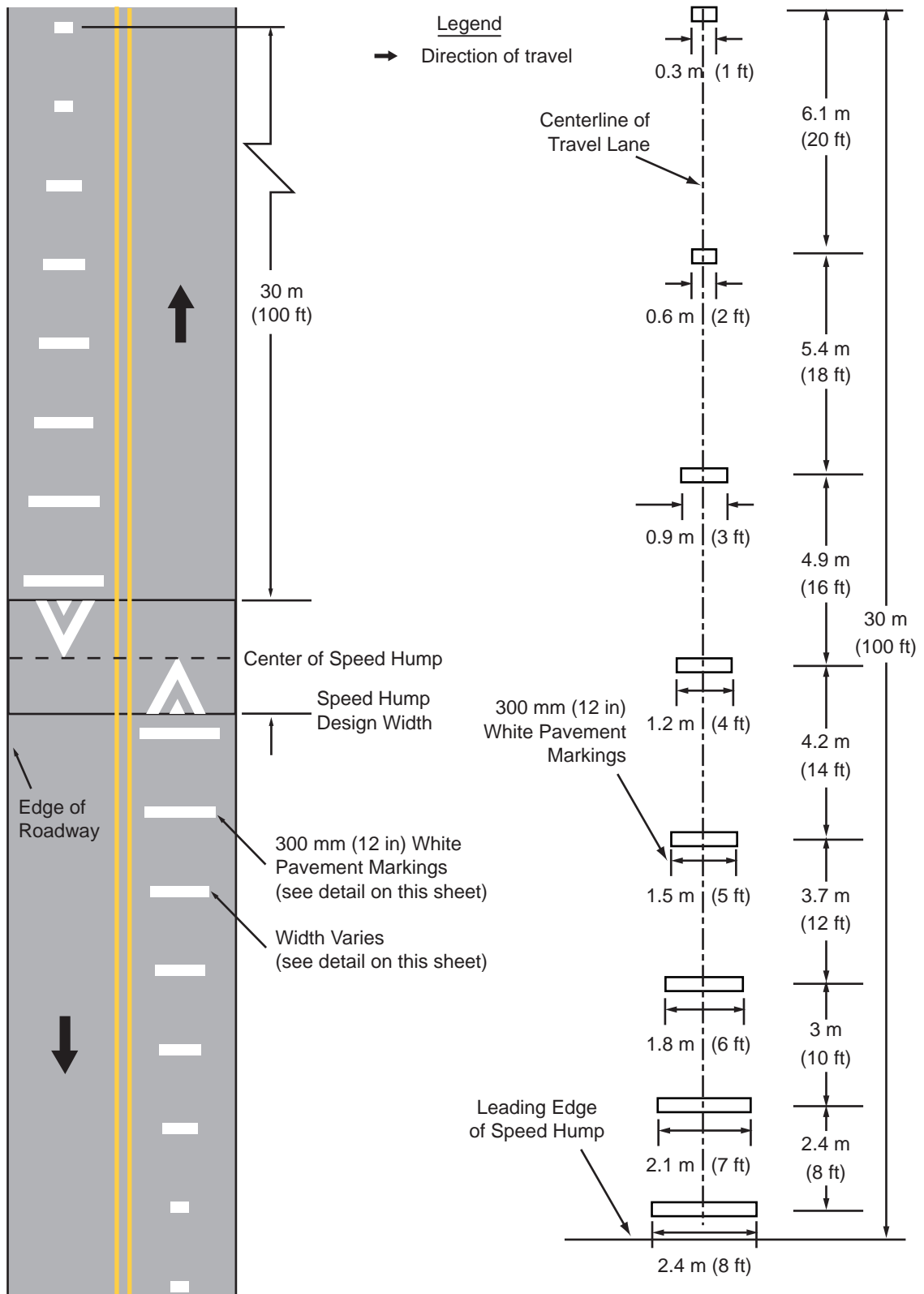

DETAIL - SPEED HUMP ADVANCE WARNING MARKINGS

CHAPTER 3C. OBJECT MARKERS

Section 3C.01 Object Marker Design and Placement Height

Support:

Object markers are used to mark obstructions within or adjacent to the roadway.

Standard:

When used, object markers shall consist of an arrangement of one or more of the following types:

Type 1 – either a marker consisting of nine yellow retroreflectors, each with a minimum diameter of 75 mm (3 in), mounted symmetrically on a yellow or black diamond panel 450 mm (18 in) or more on a side; or on an all-yellow retroreflective diamond panel of the same size.

Type 2 – either a marker consisting of three yellow retroreflectors, each with a minimum diameter of 75 mm (3 in), arranged either horizontally or vertically on a white panel; or on an all-yellow retroreflective panel, measuring at least 150 x 300 mm (6 x 12 in).

Type 3 – a striped marker, 300 x 900 mm (12 x 36 in), consisting of a vertical rectangle with alternating black and retroreflective yellow stripes sloping downward at an angle of 45 degrees toward the side of the obstruction on which traffic is to pass. The minimum width of the yellow stripe shall be 75 mm (3 in).

Support:

A better appearance can be achieved if the black stripes are wider than the yellow stripes.

Type 3 object markers with stripes that begin at the upper right side and slope downward to the lower left side are designated as right object markers (OM-3R). Object markers with stripes that begin at the upper left side and slope downward to the lower right side are designated as left object markers (OM-3L).

Guidance:

When used for marking objects in the roadway or objects that are 2.4 m (8 ft) or less from the shoulder or curb, the mounting height to the bottom of the object marker should be at least 1.2 m (4 ft) above the surface of the nearest traffic lane.

When used to mark objects more than 2.4 m (8 ft) from the shoulder or curb, the mounting height to the bottom of the object marker should be at least 1.2 m (4 ft) above the ground.

Typical Type 1 Object Markers

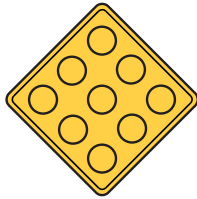

OM1-1

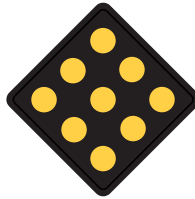

OM1-2

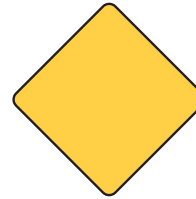

OM1-3

Typical Type 2 Object Markers

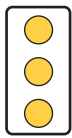

OM2-1V



OM2-2V

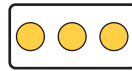

OM2-1H



OM2-2H

Typical Type 3 Object Markers



OM-3L



OM-3C



OM-3R

Typical End of Road Markers

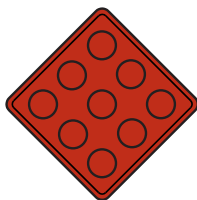

OM4-1

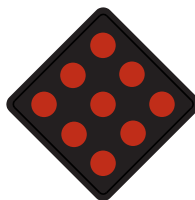

OM4-2

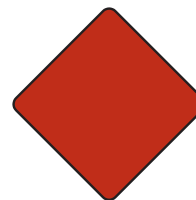

OM4-3

Option:

When object markers or markings are applied to an object that by its nature requires a lower or higher mounting, the vertical mounting height may vary according to need.

Section 3C.02 Markings for Objects in the Roadway

Standard:

Obstructions within the roadway shall be marked with a Type 1 or Type 3 object marker. In addition to markers on the face of the obstruction, warning of approach to the obstruction shall be given by appropriate pavement markings (see Section 3B.10).

Option:

To provide additional emphasis, large surfaces such as bridge piers may be painted with diagonal stripes, 300 mm (12 in) or greater in width, similar in design to the Type 3 object marker.

Standard:

The alternating black and retroreflective yellow stripes (OM-3L, OM-3R) shall be sloped down at an angle of 45 degrees toward the side on which traffic is to pass the obstruction. If traffic can pass to either side of the obstruction, the alternating black and retroreflective yellow stripes (OM-3C) shall form chevrons that point upwards.

Option:

Appropriate signs (see Sections 2B.28 and 2C.18) directing traffic to one or both sides of the obstruction may be used instead of the object marker.

Section 3C.03 Markings for Objects Adjacent to the Roadway

Support:

Objects not actually in the roadway are sometimes so close to the edge of the road that they need a marker. These include underpass piers, bridge abutments, handrails, and culvert headwalls. In other cases there might not be a physical object involved, but other roadside conditions exist, such as narrow shoulders, drop-offs, gores, small islands, and abrupt changes in the roadway alignment, that might make it undesirable for a road user to leave the roadway, and therefore would create a need for a marker.

Option:

Type 2 or Type 3 object markers may be used at locations such as those described in the preceding Support paragraph.

Standard:

If used, the inside edge of the marker shall be in line with the inner edge of the obstruction.

Guidance:

Standard warning signs (see Chapter 2C) should also be used where applicable.

Section 3C.04 End-of-Roadway Markings

Support:

The end-of-roadway marker is used to warn and alert road users of the end of a roadway in other than construction or maintenance areas.

Standard:

The end-of-roadway marker shall be one of the following: a marker consisting of nine red retroreflectors, each with a minimum diameter of 75 mm (3 in), mounted symmetrically on a red or black diamond panel 450 mm (18 in) or more on a side; or on a retroreflective red diamond panel 450 mm (18 in) or more on a side.

Option:

The end-of-roadway marker may be used in instances where there are no alternate vehicular paths.

Where conditions warrant, more than one marker, or a larger marker with or without a Type III barricade (see Section 3F.01), may be used at the end of the roadway.

Standard:

The minimum mounting height of an end-of-the-roadway marker shall be 1.2 m (4 ft).

Guidance:

Appropriate advance warning signs (see Chapter 2C) should be used.

CHAPTER 3D. DELINEATORS

Section 3D.01 Delineators

Support:

Delineators are particularly beneficial at locations where the alignment might be confusing or unexpected, such as at lane reduction transitions and curves. Delineators are effective guidance devices at night and during adverse weather. An important advantage of delineators in certain locations is that they remain visible when the roadway is wet or snow covered.

Standard:

Delineators are considered guidance devices rather than warning devices.

Option:

Delineators may be used on long continuous sections of highway or through short stretches where there are changes in horizontal alignment.

Section 3D.02 Delineator Design

Standard:

Delineators shall be retroreflective devices mounted above the roadway surface and along the side of the roadway in a series to indicate the alignment of the roadway. Delineators shall consist of retroreflector units that are capable of clearly retroreflecting light under normal atmospheric conditions from a distance of 300 m (1,000 ft) when illuminated by the high beams of standard automobile lights.

Retroreflective elements for delineators shall have a minimum dimension of 75 mm (3 in).

Option:

Elongated retroreflective units of appropriate size may be used in place of two retroreflectors mounted as a unit.

Section 3D.03 Delineator Application

Standard:

The color of delineators shall conform to the color of edge lines stipulated in Sections 3B.01 and 3B.04.

Single delineators shall be provided on the right side of expressways and freeways and on at least one side of interchange ramps, except in the following cases:

- A. On tangent sections of expressways and freeways when all of the following conditions are met:**
 - 1. Raised pavement markers are used continuously on lane lines throughout all curves and on all tangents to supplement pavement markings.**
 - 2. Where whole routes or substantial portions of routes have large sections of tangent alignment.**
 - 3. Roadside delineators are used to lead into all curves.**
- B. On sections of roadways where continuous lighting is in operation between interchanges.**

Option:

Delineators may be provided on other classes of roads. Single delineators may be provided on the left side of roadways.

Guidance:

Single delineators should be provided on the outside of curves on interchange ramps.

Where median crossovers are provided for official or emergency use on divided highways and where these crossovers are to be marked, a double yellow delineator should be placed on the left side of the through roadway on the far side of the crossover for each roadway.

Double or vertically elongated delineators should be installed at 30 m (100 ft) intervals along acceleration and deceleration lanes.

Option:

Red delineators may be used on the reverse side of any delineator where it would be viewed by a road user traveling in the wrong direction on that particular ramp or roadway.

Delineators of the appropriate color may be used to indicate a lane reduction transition where either an outside or inside lane merges into an adjacent lane.

Guidance:

For lane reduction transitions, the delineators should be used adjacent to the lane or lanes reduced for the full length of the transition and should be so placed and spaced to show the reduction (see Figure 3B-12).

Support:

Delineators are not necessary for traffic moving in the direction of a wider pavement or on the side of the roadway where the alignment is not affected by the lane reduction transition.

Guidance:

On a highway with continuous delineation on either or both sides, delineators should be carried through transitions.

Option:

On a highway with continuous delineation on either or both sides, the spacing between a series of delineators may be closer.

Standard:

When used on a truck escape ramp, delineators shall be red.

Guidance:

Red delineators should be placed on both sides of truck escape ramps. The delineators should be spaced at 15 m (50 ft) intervals for a distance sufficient to identify the ramp entrance. Delineator spacing beyond the ramp entrance should be adequate for guidance according to the length and design of the escape ramp.

Section 3D.04 Delineator Placement and Spacing**Guidance:**

Delineators should be mounted on suitable supports so that the top of the highest retroreflector is 1.2 m (4 ft) above the near roadway edge. They should be placed 0.6 to 2.4 m (2 to 8 ft) outside the outer edge of the shoulder, or if appropriate, in line with the roadside barrier that is 2.4 m (8 ft) or less outside the outer edge of the shoulder.

Delineators should be placed at a constant distance from the edge of the roadway, except that where a guardrail or other obstruction intrudes into the space between the pavement edge and the extension of the line of the delineators, the delineators should be transitioned to be in line with or inside the innermost edge of the obstruction (see Figure 3D-1).

Delineators should be spaced 60 to 160 m (200 to 530 ft) apart on mainline tangent sections. Delineators should be spaced 30 m (100 ft) apart on ramp tangent sections.

Support:

Typical delineator installations are shown in Figure 3D-1.

Option:

When uniform spacing is interrupted by such features as driveways and intersections, delineators which would ordinarily be located within the features may be relocated in either direction for a distance not exceeding one quarter of the uniform spacing. Delineators still falling within such features may be eliminated.

Delineators may be transitioned in advance of a lane transition or obstruction as a guide for oncoming traffic.

Guidance:

The spacing of delineators should be adjusted on approaches to and throughout horizontal curves so that several delineators are always simultaneously visible to the road user. The approximate spacing shown in Table 3D-1 should be used.

Figure 3D-1. Typical Delineator Installation

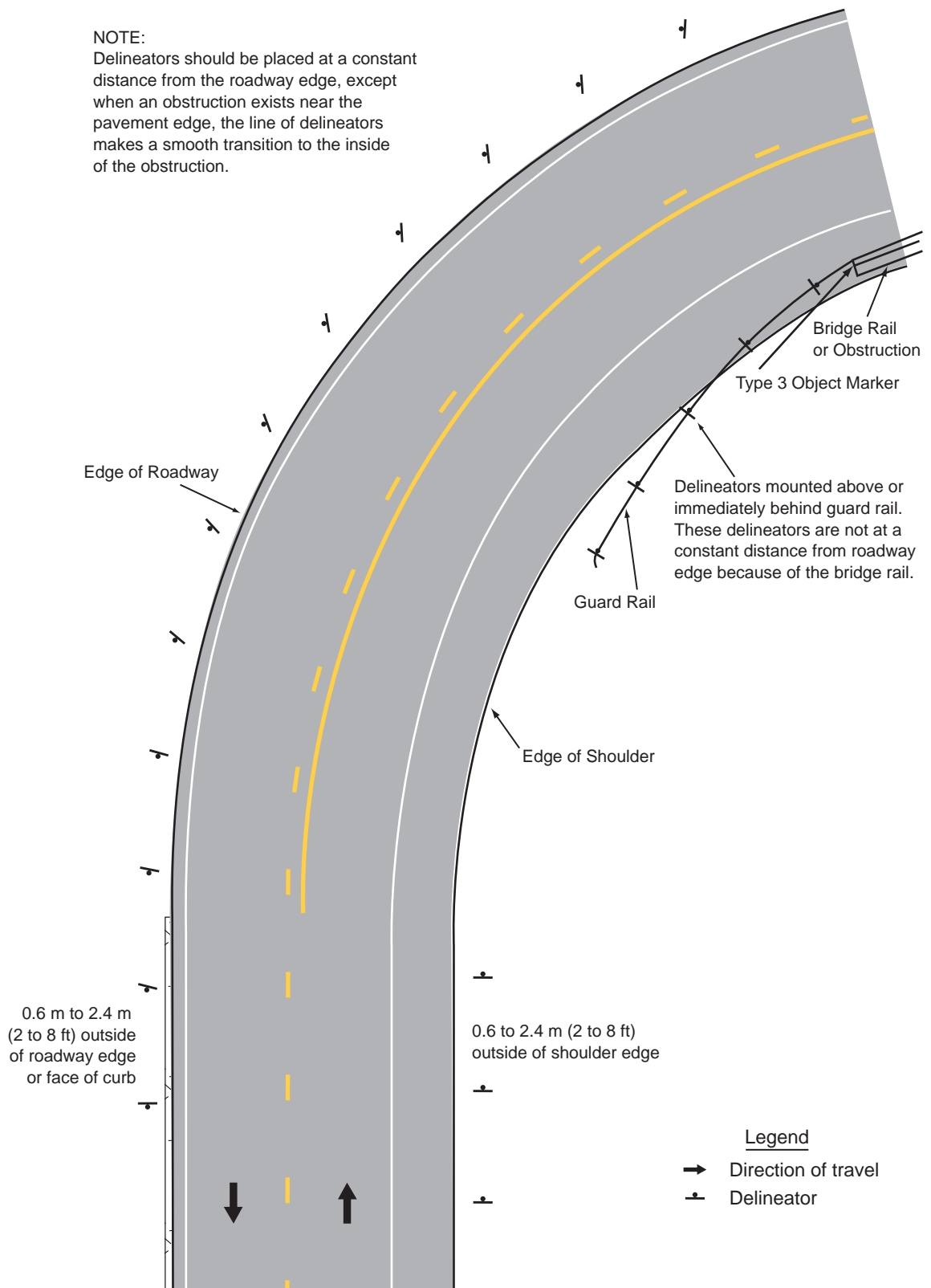

Table 3D-1. Approximate Spacing for Delineators on Horizontal Curves

Radius (R) of Curve (meters)	Approximate Spacing (S) on Curve (meters)	Radius (R) of Curve (feet)	Approximate Spacing (S) on Curve (feet)
15	6	50	20
35	8	115	25
55	11	180	35
75	13	250	40
95	15	300	50
125	18	400	55
155	20	500	65
185	22	600	70
215	24	700	75
245	26	800	80
275	27	900	85
305	29	1,000	90

Distances in feet were rounded to the nearest 5 feet.

Spacing for specific radii may be interpolated from table. The minimum spacing should be 6 m (20 ft). The spacing on curves should not exceed 90 m (300 ft). In advance of or beyond a curve, and proceeding away from the end of the curve, the spacing of the first delineator is 2S, the second 3S, and the third 6S but not to exceed 90 m (300 ft). S refers to the delineator spacing for specific radii computed from the formula $S=1.7\sqrt{R-15}$ for metric units and $S=3\sqrt{R-50}$ for English units.

CHAPTER 3E. COLORED PAVEMENTS

Section 3E.01 General

Support:

When used for guidance or regulation of traffic, colored pavements are traffic control devices. Colored pavements also are sometimes used to supplement other traffic control devices.

Guidance:

Colored pavements should be used only where they contrast significantly with adjoining paved areas.

Standard:

Colored pavements shall not be used as a traffic control device, unless the device is applicable at all times.

Colors for pavements used as traffic control devices shall be limited to the following:

- A. Red shall be used only on the approach to a STOP sign that is in use 24 hours a day.**
- B. Yellow shall be used only for median islands separating traffic flows in opposite directions.**
- C. White shall be used for delineation on shoulders, on channelizing islands where traffic passes on both sides in the same general direction, and for crosswalks.**

Guidance:

The length of the red colored pavement on the approach to a STOP sign should relate to the 85th-percentile speed, or the posted or statutory speed limit and should give the road user 2 to 4 seconds of warning.

CHAPTER 3F. BARRICADES AND CHANNELIZING DEVICES

Section 3F.01 Barricades

Standard:

When used to warn and alert road users of the terminus of a roadway in other than temporary traffic control zones, barricades shall meet the design criteria of Section 6F.60 for a Type III barricade, except that the colors of the stripes shall be retroreflective white and retroreflective red.

Option:

An end-of-roadway marker or markers may be used as described in Section 3C.04. Barricades may be used to mark any of the following conditions:

- A. The roadway ends in a dead end or cul-de-sac with no outlet.
- B. A ramp or lane is closed for operational purposes.
- C. The permanent or semi-permanent closure or termination of a roadway.

Guidance:

Appropriate advance warning signs (see Chapter 2C) should be used.

Section 3F.02 Channelizing Devices

Option:

Channelizing devices, such as traffic cones and tubular markers, may be used for general traffic control purposes such as adding emphasis to reversible lane delineation, channelizing lines, or islands.

Standard:

Channelizing devices shall conform to Section 6F.55 and shall be a minimum of 450 mm (18 in) in height.

The minimum height of cones shall be 700 mm (28 in) for use on freeways and other high-speed roadways, and on all facilities when used during hours of darkness or whenever more conspicuous guidance is needed.

The color of channelizing devices used outside of temporary traffic control zones shall be either orange or the same color as the pavement marking that they supplement, or for which they are substituted.

For nighttime use, channelizing devices shall be retroreflective.

Retroreflection of tubular markers shall be a minimum of two 75 mm (3 in) white bands placed a maximum of 50 mm (2 in) from the top with a maximum of 150 mm (6 in) between the bands.

Retroreflection of cones shall be provided by a minimum 150 mm (6 in) white band placed a minimum of 75 mm (3 in) but no more than 100 mm (4 in) from the top.

Retroreflective material shall have a smooth, sealed outer surface that will display a similar color during both day and night.

When 700 mm (28 in) or larger size cones are used, the standard 150 mm (6 in) band shall be supplemented with an additional 100 mm (4 in) white band spaced a minimum of 50 mm (2 in) below the 150 mm (6 in) band.

Guidance:

Channelizing devices should be kept clean and bright to maximize target value.

CHAPTER 3G. ISLANDS

Section 3G.01 General

Support:

Chapter 3G addresses the characteristics of islands as traffic-control devices. Criteria for the design of islands are set forth in "A Policy on Geometric Design of Highways and Streets" (see Section 1A.11).

Standard:

An island for traffic control purposes shall be the defined area between traffic lanes for control of vehicular movements or for pedestrian refuge. Within an intersection area, a median or an outer separation shall be an island.

Option:

An island may be designated by pavement markings, channelizing devices, curbs, pavement edges, or other devices.

Section 3G.02 Approach-End Treatment

Guidance:

The ends of islands first approached by traffic should be preceded by a gradually diverging marking on the roadway surface, to guide vehicles into desired paths of travel along the island edge.

Option:

Approach-end markings that can be readily crossed even at considerable speed may contain slightly raised (usually less than 25 mm (1 in) high) sections of coarse aggregate or other suitable materials to create rumble sections that provide increased visibility of the marked areas and that produce an audible warning to road users traveling across them.

Standard:

Rumble strips or other devices, when used in advance of islands having raised curbs, shall not be placed in such a manner as to constitute an unexpected obstacle.

Guidance:

Bars or buttons should not project more than 25 mm (1 in) to 75 mm (3 in) above the pavement surface, and should be designed so that any wheel encroachment within the area will be obvious to the vehicle operator, but will not result in loss of control of the vehicle.

Option:

Bars or buttons may be preceded by rumble sections, or their height may be gradually increased as approached by traffic.

Pavement markings may be used with raised bars to better designate the island area.

Section 3G.03 Island Marking Application

Standard:

Markings, as related to islands, shall consist only of pavement and curb markings, object markers, and delineators.

On the approach to islands, the triangular neutral area in advance of the end of the island shall include pavement markings as described in Section 3B.10.

Option:

As indicated in Section 3G.02, rumble sections, or other similar traffic control designs which contrast with the pavement surface, may also be applied in the triangular neutral area in advance of the end of an island.

Guidance:

When raised bars or buttons are used in these neutral areas, they should be marked with white or yellow retroreflective materials, as determined by the direction or directions of travel they separate.

Section 3G.04 Island Marking Colors

Guidance:

Islands outlined by curbs or pavement markings should be marked with retroreflective white or yellow material as determined by the direction or directions of travel they separate (see Section 3A.05).

The retroreflective area should be of sufficient length to denote the general alignment of the edge of the island along which vehicles travel, including the approach nose, when viewed from the approach to the island.

Option:

On long islands, curb retroreflection may be discontinued such that it does not extend for the entire length of the curb, especially if the island is illuminated or marked with delineators.

Section 3G.05 Island Object Markers

Option:

Object markers may be installed alone or in combination with signs (such as KEEP RIGHT, KEEP LEFT, double arrows, or guide signs) located within the island.

Section 3G.06 Island Delineators

Standard:

Delineators installed on islands shall be the same colors as the related edgelines except that, when facing wrong-way traffic, they shall be red (see Section 3D.03).

Each roadway through an intersection shall be considered separately in positioning delineators to assure maximum effectiveness.



PART 4

Highway Traffic Signals

MUTCD 2000

Manual on Uniform Traffic Control Devices

m i l l e n n i u m e d i t i o n

December 2000



U.S. Department
of Transportation

**Federal Highway
Administration**

PART 4. HIGHWAY TRAFFIC SIGNALS**TABLE OF CONTENTS**

	<u>Page</u>
CHAPTER 4A. GENERAL	Dec., 2000
Section 4A.01	Types.....4A-1
Section 4A.02	Definitions Relating to Highway Traffic Signals.....4A-1
CHAPTER 4B. TRAFFIC CONTROL SIGNALS - GENERAL	Dec., 2000
Section 4B.01	General.....4B-1
Section 4B.02	Basis of Installation or Removal of Traffic Control Signals.....4B-1
Section 4B.03	Advantages and Disadvantages of Traffic Control Signals.....4B-2
Section 4B.04	Alternatives to Traffic Control Signals4B-3
Section 4B.05	Adequate Roadway Capacity4B-4
CHAPTER 4C. TRAFFIC CONTROL SIGNAL NEEDS STUDIES	Dec., 2000
Section 4C.01	Studies and Factors for Justifying Traffic Control Signals4C-1
Section 4C.02	Warrant 1, Eight-Hour Vehicular Volume4C-3
Section 4C.03	Warrant 2, Four-Hour Vehicular Volume.....4C-6
Section 4C.04	Warrant 3, Peak Hour4C-6
Section 4C.05	Warrant 4, Pedestrian Volume4C-8
Section 4C.06	Warrant 5, School Crossing4C-11
Section 4C.07	Warrant 6, Coordinated Signal System4C-12
Section 4C.08	Warrant 7, Crash Experience4C-12
Section 4C.09	Warrant 8, Roadway Network4C-13
CHAPTER 4D. TRAFFIC CONTROL SIGNAL FEATURES	Dec., 2000
Section 4D.01	General4D-1
Section 4D.02	Responsibility For Operation and Maintenance.....4D-2
Section 4D.03	Provisions For Pedestrians4D-3
Section 4D.04	Meaning of Vehicular Signal Indications.....4D-3
Section 4D.05	Application of Steady Signal Indications.....4D-6
Section 4D.06	Application of Steady Signal Indications For Left Turns4D-8
Section 4D.07	Application of Steady Signal Indications For Right Turns4D-11
Section 4D.08	Prohibited Steady Signal Indications4D-14
Section 4D.09	Unexpected Conflicts During Green or Yellow Intervals4D-14
Section 4D.10	Yellow Change and Red Clearance Intervals.....4D-15
Section 4D.11	Application of Flashing Signal Indications.....4D-16
Section 4D.12	Flashing Operation of Traffic Control Signals.....4D-17
Section 4D.13	Preemption and Priority Control of Traffic Control Signals.....4D-19
Section 4D.14	Coordination of Traffic Control Signals4D-21
Section 4D.15	Size, Number, and Location of Signal Faces by Approach4D-22

Section 4D.16	Number and Arrangement of Signal Sections in Vehicular Traffic Control Signal Faces	4D-28
Section 4D.17	Visibility, Shielding, and Positioning of Signal Faces	4D-30
Section 4D.18	Design, Illumination, and Color of Signal Sections	4D-33
Section 4D.19	Lateral Placement of Signal Supports and Cabinets	4D-34
Section 4D.20	Temporary Traffic Control Signals	4D-35
Section 4D.21	Traffic Signal Signs, Auxiliary	4D-36

CHAPTER 4E. PEDESTRIAN CONTROL FEATURESDec., 2000

Section 4E.01	Pedestrian Signal Heads	4E-1
Section 4E.02	Meaning of Pedestrian Signal Indications	4E-1
Section 4E.03	Application of Pedestrian Signal Heads	4E-2
Section 4E.04	Size, Design, and Illumination of Pedestrian Signal Indications	4E-2
Section 4E.05	Location and Height of Pedestrian Signal Heads	4E-3
Section 4E.06	Accessible Pedestrian Signals	4E-5
Section 4E.07	Pedestrian Detectors	4E-8
Section 4E.08	Accessible Pedestrian Signal Detectors	4E-10
Section 4E.09	Pedestrian Intervals and Signal Phases	4E-12

**CHAPTER 4F. TRAFFIC CONTROL SIGNALS FOR EMERGENCY
VEHICLE ACCESSDec., 2000**

Section 4F.01	Applications of Emergency-Vehicle Traffic Control Signals	4F-1
Section 4F.02	Design of Emergency-Vehicle Traffic Control Signals	4F-1
Section 4F.03	Operation of Emergency-Vehicle Traffic Control Signals	4F-2

**CHAPTER 4G. TRAFFIC CONTROL SIGNALS FOR ONE-LANE,
TWO-WAY FACILITIESDec., 2000**

Section 4G.01	Application of Traffic Control Signals for One-Lane, Two-Way Facilities	4G-1
Section 4G.02	Design of Traffic Control Signals for One-Lane, Two-Way Facilities	4G-1
Section 4G.03	Operation of Traffic Control Signals for One-Lane, Two-Way Facilities	4G-2

**CHAPTER 4H. TRAFFIC CONTROL SIGNALS FOR FREEWAY ENTRANCE
RAMPSDec., 2000**

Section 4H.01	Application of Freeway Entrance Ramp Control Signals	4H-1
Section 4H.02	Design of Freeway Entrance Ramp Control Signals	4H-2

CHAPTER 4I. TRAFFIC CONTROL FOR MOVABLE BRIDGESDec., 2000

Section 4I.01	Application of Traffic Control for Movable Bridges	4I-1
Section 4I.02	Design and Location of Movable Bridge Signals and Gates	4I-2
Section 4I.03	Operation of Movable Bridge Signals and Gates	4I-4

CHAPTER 4J. LANE-USE CONTROL SIGNALSDec., 2000

Section 4J.01	Application of Lane-Use Control Signals	4J-1
Section 4J.02	Meaning of Lane-Use Control Signal Indications.....	4J-2
Section 4J.03	Design of Lane-Use Control Signals.....	4J-3
Section 4J.04	Operation of Lane-Use Control Signals	4J-5

CHAPTER 4K. FLASHING BEACONSDec., 2000

Section 4K.01	General Design and Operation of Flashing Beacons	4K-1
Section 4K.02	Intersection Control Beacon.....	4K-1
Section 4K.03	Warning Beacon	4K-2
Section 4K.04	Speed Limit Sign Beacon.....	4K-3
Section 4K.05	Stop Beacon.....	4K-4

CHAPTER 4L. IN-ROADWAY LIGHTSDec., 2000

Section 4L.01	Application of In-Roadway Lights	4L-1
Section 4L.02	In-Roadway Warning Lights at Crosswalks	4L-1

FIGURES**CHAPTER 4C. TRAFFIC CONTROL SIGNAL NEEDS STUDIES**

Figure 4C-1	Warrant 2 - Four-Hour Vehicular Volume	4C-7
Figure 4C-2	Warrant 2 - Four-Hour Vehicular Volume (70% Factor).....	4C-7
Figure 4C-3	Warrant 3 - Peak Hour	4C-9
Figure 4C-4	Warrant 3 - Peak Hour (70% Factor)	4C-9

CHAPTER 4D. TRAFFIC CONTROL SIGNAL FEATURES

Figure 4D-1	Maximum Mounting Height of Signal Faces Located Between 12 m (40 ft) and 16 m (53 ft) from Stop Line	4D-25
Figure 4D-2	Horizontal Location of Signal Faces.....	4D-26
Figure 4D-3	Typical Arrangements of Signal Lenses in Signal Faces.....	4D-31

CHAPTER 4E. PEDESTRIAN CONTROL FEATURES

Figure 4E-1	Typical Pedestrian Signal Indications.....	4E-4
Figure 4E-2	Recommended Pushbutton Locations for Accessible Pedestrian Signals	4E-11

CHAPTER 4J. LANE-USE CONTROL SIGNALS

Figure 4J-1	Left-Turn Lane-Use Control Signals	4J-3
-------------	--	------

TABLES

CHAPTER 4C. TRAFFIC CONTROL SIGNAL NEEDS STUDIES

Table 4C-1 Warrant 1, Eight-Hour Vehicular Volume4C-5

CHAPTER 4D. TRAFFIC CONTROL SIGNAL FEATURES

Table 4D-1 Minimum Sight Distance4D-23

CHAPTER 4A. GENERAL

Section 4A.01 Types

Support:

The following types and uses of highway traffic signals are discussed in Part 4: traffic control signals; pedestrian signals; emergency-vehicle traffic control signals; traffic control signals for one-lane, two-way facilities; traffic control signals for freeway entrance ramps; traffic control signals for movable bridges; lane-use control signals; flashing beacons; and in-roadway lights.

Section 4A.02 Definitions Relating to Highway Traffic Signals

Standard:

The following technical terms, when used in Part 4, shall be defined as follows:

1. **Accessible Pedestrian Signal** - a device that communicates information about pedestrian timing in non-visual format such as audible tones, verbal messages, and/or vibrating surfaces.
2. **Active Grade Crossing Warning System** - the flashing-light signals, with or without warning gates, together with the necessary control equipment used to inform road users of the approach or presence of trains at highway-rail grade crossings.
3. **Actuated Operation** - a type of traffic control signal operation in which some or all signal phases are operated on the basis of actuation.
4. **Actuation** - initiation of a change in or extension of a traffic signal phase through the operation of any type of detector.
5. **Approach** - all lanes of traffic moving towards an intersection or a mid-block location from one direction, including any adjacent parking lane(s).
6. **Average Day** - a day representing traffic volumes normally and repeatedly found at a location, typically a weekday when volumes are influenced by employment or a weekend when volumes are influenced by entertainment or recreation.
7. **Backplate** - a thin strip of material that extends outward from and parallel to a signal face on all sides of a signal housing to provide a background for improved visibility of the signal indications.

- 8. Beacon - a highway traffic signal with one or more signal sections that operates in a flashing mode.**
- 9. Conflict Monitor - a device used to detect and respond to improper or conflicting signal indications and improper operating voltages in a traffic controller assembly.**
- 10. Controller Assembly - a complete electrical device mounted in a cabinet for controlling the operation of a highway traffic signal.**
- 11. Controller Unit - that part of a controller assembly that is devoted to the selection and timing of the display of signal indications.**
- 12. Crosswalk - (a) that part of a roadway at an intersection included within the connections of the lateral lines of the sidewalks on opposite sides of the highway measured from the curbs or in the absence of curbs, from the edges of the traversable roadway, and in the absence of a sidewalk on one side of the roadway, the part of a roadway included within the extension of the lateral lines of the sidewalk at right angles to the centerline; (b) any portion of a roadway at an intersection or elsewhere distinctly indicated for pedestrian crossing by lines or other markings on the surface.**
- 13. Cycle Length - the time required for one complete sequence of signal indications.**
- 14. Dark Mode - the lack of all signal indications at a signalized location. (The dark mode is most commonly associated with power failures, ramp meters, beacons, and some movable bridge signals.)**
- 15. Detector - a sensing device used for determining the presence or passage of vehicles or pedestrians.**
- 16. Emergency Vehicle Traffic Control Signal - a special traffic control signal that assigns the right-of-way to an authorized emergency vehicle.**
- 17. Flasher - a device used to turn highway traffic signal indications on and off at a repetitive rate of approximately once per second.**
- 18. Flashing (Flashing Mode) - a mode of operation in which a traffic signal indication is turned on and off repetitively.**
- 19. Full-actuated Operation - a type of traffic control signal operation in which all signal phases function on the basis of actuation.**

- 20. Highway Traffic Signal - a power-operated traffic control device by which traffic is warned or directed to take some specific action. These devices do not include power-operated signs, illuminated pavement markers, barricade warning lights, or steady-burning electric lamps.**
- 21. In-Roadway Lights - a special type of highway traffic signal installed in the roadway surface to warn road users that they are approaching a condition on or adjacent to the roadway that might not be readily apparent and might require the road users to slow down and/or come to a stop.**
- 22. Intersection - (a) the area embraced within the prolongation or connection of the lateral curb lines, or if none, the lateral boundary lines of the roadways of two highways that join one another at, or approximately at, right angles, or the area within which vehicles traveling on different highways that join at any other angle may come into conflict; (b) the junction of an alley or driveway with a roadway or highway shall not constitute an intersection.**
- 23. Intersection Control Beacon - a beacon used only at an intersection to control two or more directions of travel.**
- 24. Interval - the part of a signal cycle during which signal indications do not change.**
- 25. Interval Sequence - the order of appearance of signal indications during successive intervals of a signal cycle.**
- 26. Lane-use Control Signal - a signal face displaying signal indications to permit or prohibit the use of specific lanes of a roadway or to indicate the impending prohibition of such use.**
- 27. Lens - see Signal Lens.**
- 28. Louver - a device that can be mounted inside a signal visor to restrict visibility of a signal indication from the side or to limit the visibility of the signal indication to a certain lane or lanes.**
- 29. Major Street - the street normally carrying the higher volume of vehicular traffic.**
- 30. Malfunction Management Unit - same as Conflict Monitor.**
- 31. Minor Street - the street normally carrying the lower volume of vehicular traffic.**

- 32. Movable Bridge Resistance Gate** - a type of traffic gate, which is located downstream of the movable bridge warning gate, that provides a physical deterrent to vehicle and/or pedestrian traffic when placed in the appropriate position.
- 33. Movable Bridge Warning Gate** - a type of traffic gate designed to warn, but not primarily to block, vehicle and/or pedestrian traffic when placed in the appropriate position.
- 34. Pedestrian Change Interval** - an interval during which the flashing UPRAISED HAND (symbolizing DONT WALK) signal indication is displayed. When a verbal message is provided at an accessible pedestrian signal, the verbal message is "wait."
- 35. Pedestrian Clearance Time** - the time provided for a pedestrian crossing in a crosswalk, after leaving the curb or shoulder, to travel to the center of the farthest traveled lane or to a median.
- 36. Pedestrian Signal Head** - a signal head, which contains the symbols WALKING PERSON (symbolizing WALK) and UPRAISED HAND (symbolizing DONT WALK), that is installed to direct pedestrian traffic at a traffic control signal.
- 37. Permissive Mode** - a mode of traffic control signal operation in which, when a CIRCULAR GREEN signal indication is displayed, left or right turns may be made after yielding to pedestrians and/or oncoming traffic.
- 38. Platoon** - a group of vehicles or pedestrians traveling together as a group, either voluntarily or involuntarily, because of traffic signal controls, geometrics, or other factors.
- 39. Preemption Control** - the transfer of normal operation of a traffic control signal to a special control mode of operation.
- 40. Pretimed Operation** - a type of traffic control signal operation in which none of the signal phases function on the basis of actuation.
- 41. Priority Control** - a means by which the assignment of right-of-way is obtained or modified.
- 42. Protected Mode** - a mode of traffic control signal operation in which left or right turns may be made when a left or right GREEN ARROW signal indication is displayed.

- 43. Pushbutton - a button to activate pedestrian timing.**
- 44. Pushbutton Locator Tone - a repeating sound that informs approaching pedestrians that they are required to push a button to actuate pedestrian timing and that enables pedestrians who have visual disabilities to locate the pushbutton.**
- 45. Ramp Control Signal - a highway traffic signal installed to control the flow of traffic onto a freeway at an entrance ramp or at a freeway-to-freeway ramp connection.**
- 46. Ramp Meter - see Ramp Control Signal.**
- 47. Red Clearance Interval - an optional interval that follows a yellow change interval and precedes the next conflicting green interval.**
- 48. Right-of-Way (Assignment) - the permitting of vehicles and/or pedestrians to proceed in a lawful manner in preference to other vehicles or pedestrians by the display of signal indications.**
- 49. Roadway Network - a geographical arrangement of intersecting roadways.**
- 50. Semi-Actuated Operation - a type of traffic control signal operation in which at least one, but not all, signal phases function on the basis of actuation.**
- 51. Signal Coordination - the establishment of timed relationships between adjacent traffic control signals.**
- 52. Signal Face - the front part of a signal head.**
- 53. Signal Head - an assembly of one or more signal faces together with the associated signal housings.**
- 54. Signal Housing - that part of a signal section that protects the light source and other required components.**
- 55. Signal Indication - the illumination of a signal lens or equivalent device.**
- 56. Signal Lens - that part of the signal section that redirects the light coming directly from the light source and its reflector, if any.**
- 57. Signal Phase - the right-of-way, yellow change, and red clearance intervals in a cycle that are assigned to an independent traffic movement or combination of movements.**
- 58. Signal Section - the assembly of a signal housing, signal lens, and light**

source with necessary components to be used for providing one signal indication.

- 59. Signal System - two or more traffic control signals operating in signal coordination.**
- 60. Signal Timing - the amount of time allocated for the display of a signal indication.**
- 61. Signal Visor - that part of a signal section that directs the signal indication specifically to approaching traffic and reduces the effect of direct external light entering the signal lens.**
- 62. Signal Warrant - a threshold condition that, if found to be satisfied as part of an engineering study, shall result in analysis of other traffic conditions or factors to determine whether a traffic control signal or other improvement is justified.**
- 63. Speed Limit Sign Beacon - a beacon used to supplement a SPEED LIMIT sign.**
- 64. Steady (Steady Mode) - the continuous illumination of a signal indication for the duration of an interval, signal phase, or consecutive signal phases.**
- 65. Stop Beacon - a beacon used to supplement a STOP sign, a DO NOT ENTER sign, or a WRONG WAY sign.**
- 66. Traffic Control Signal (Traffic Signal) - any highway traffic signal by which traffic is alternately directed to stop and permitted to proceed.**
- 67. Vibrotactile Pedestrian Device - a device that communicates, by touch, information about pedestrian timing using a vibrating surface.**
- 68. Visibility-Limited Signal Face or Signal Section - a type of signal face or signal section designed to restrict the visibility of a signal indication from the side, to a certain lane or lanes, or to a certain distance from the stop line.**
- 69. Walk Interval - an interval during which the WALKING PERSON (symbolizing WALK) signal indication is displayed. When a verbal message is provided at an accessible pedestrian signal, the verbal message is "walk sign."**
- 70. Warning Beacon - a beacon used only to supplement an appropriate warning or regulatory sign or marker.**
- 71. Yellow Change Interval - the first interval following the green interval during which the yellow signal indication is displayed.**

CHAPTER 4B. TRAFFIC CONTROL SIGNALS - GENERAL

Section 4B.01 General

Standard:

A traffic control signal (traffic signal) shall be defined as any highway traffic signal by which traffic is alternately directed to stop and permitted to proceed.

Traffic shall be defined as pedestrians, bicyclists, ridden or herded animals, vehicles, streetcars, and other conveyances either singularly or together while using any highway for purposes of travel.

Support:

Words such as pedestrians and bicyclists are used redundantly in selected sections of Part 4 to encourage sensitivity to these elements of "traffic."

Standards for traffic control signals are important because traffic control signals need to attract the attention of virtually every road user, including those who are older, those with impaired vision who meet legal requirements, as well as those who are fatigued or distracted, or who are not expecting to encounter a signal at a particular location. Standards for traffic control signals are also important because signals need to function reliably under a wide range of conditions including day and night, adverse weather, and visually-complex surroundings.

Section 4B.02 Basis of Installation or Removal of Traffic Control Signals

Guidance:

The selection and use of traffic control signals should be based on an engineering study of roadway, pedestrian, bicyclist, and other conditions.

Support:

A careful analysis of traffic operations, pedestrian, and bicyclist needs, and other factors at a large number of signalized and unsignalized intersections, coupled with engineering judgment, has provided a series of signal warrants, described in Chapter 4C, that define the minimum conditions under which installing traffic control signals might be justified.

Guidance:

If changes in traffic patterns eliminate the need for a traffic control signal, consideration should be given to removing it and replacing it with appropriate alternative traffic control devices, if any are needed.

Option:

If the engineering study indicates that the traffic control signal is no longer justified, removal may be accomplished using the following steps:

- A. Determine the appropriate traffic control to be used after removal of the signal.
- B. Remove any sight-distance restrictions as necessary.
- C. Inform the public of the removal study, for example by installing an informational sign (or signs) with the legend TRAFFIC SIGNAL UNDER STUDY FOR REMOVAL at the signalized location in a position where it is visible to all road users.
- D. Flash or cover the signal heads for a minimum of 90 days, and install the appropriate stop control or other traffic control devices.
- E. Remove the signal if the engineering data collected during the removal study period confirms that the signal is no longer needed. Instead of total removal of the traffic control signal, the poles and cables may remain in place for 1 year after removal of the signal heads for continued analysis.

Section 4B.03 Advantages and Disadvantages of Traffic Control Signals**Support:**

When properly used, traffic control signals are valuable devices for the control of vehicular and pedestrian traffic. They assign the right-of-way to the various traffic movements and thereby profoundly influence traffic flow.

Traffic control signals that are properly designed, located, operated, and maintained will have one or more of the following advantages:

- A. They provide for the orderly movement of traffic.
- B. They increase the traffic-handling capacity of the intersection if proper physical layouts and control measures are used, and if the signal timing is reviewed and updated on a regular basis (every 2 years) to ensure that it satisfies current traffic demands.
- C. They reduce the frequency and severity of certain types of crashes, especially right-angle collisions.
- D. They are coordinated to provide for continuous or nearly continuous movement of traffic at a definite speed along a given route under favorable conditions.
- E. They are used to interrupt heavy traffic at intervals to permit other traffic, vehicular or pedestrian, to cross.

Traffic control signals are often considered a panacea for all traffic problems at intersections. This belief has led to traffic control signals being installed at many locations where they are not needed, adversely affecting the safety and efficiency of vehicular, bicycle, and pedestrian traffic.

Traffic control signals, even when justified by traffic and roadway conditions, can be ill-designed, ineffectively placed, improperly operated, or poorly maintained. Improper or unjustified traffic control signals can result in one or more of the following disadvantages:

- A. Excessive delay.
- B. Excessive disobedience of the signal indications.
- C. Increased use of less adequate routes as road users attempt to avoid the traffic control signals.
- D. Significant increases in the frequency of collisions (especially rear-end collisions).

Engineering studies of operating traffic control signals should be made to determine whether the type of installation and the timing program meet the current requirements of traffic.

Section 4B.04 Alternatives to Traffic Control Signals

Guidance:

Since vehicular delay and the frequency of some types of crashes are sometimes greater under traffic signal control than under STOP sign control, consideration should be given to providing alternatives to traffic control signals even if one or more of the signal warrants has been satisfied.

Option:

These alternatives may include, but are not limited to, the following:

- A. Installing signs along the major street to warn road users approaching the intersection.
- B. Relocating the stop line(s) and making other changes to improve the sight distance at the intersection.
- C. Installing measures designed to reduce speeds on the approaches.
- D. Installing a flashing beacon at the intersection to supplement STOP sign control.
- E. Installing flashing beacons on warning signs in advance of a STOP sign controlled intersection on major- and/or minor-street approaches.
- F. Adding one or more lanes on a minor-street approach to reduce the number of vehicles per lane on the approach.

- G. Revising the geometrics at the intersection to channelize vehicular movements and reduce the time required for a vehicle to complete a movement, which could also assist pedestrians.
- H. Installing roadway lighting if a disproportionate number of crashes occur at night.
- I. Restricting one or more turning movements, perhaps on a time-of-day basis, if alternate routes are available.
- J. If the warrant is satisfied, installing multi-way STOP sign control.
- K. Installing a roundabout.
- L. Employing other alternatives, depending on conditions at the intersection.

Section 4B.05 Adequate Roadway Capacity

Support:

The delays inherent in the alternating assignment of right-of-way at intersections controlled by traffic control signals can frequently be reduced by widening the major roadway, the minor roadway, or both roadways. Widening the minor roadway often benefits the operations on the major roadway, because it reduces the green time that must be assigned to minor-roadway traffic. In urban areas, the effect of widening can be achieved by eliminating parking on intersection approaches. It is desirable to have at least two lanes for moving traffic on each approach to a signalized intersection. Additional width on the departure side of the intersection, as well as on the approach side, will sometimes be needed to clear traffic through the intersection effectively.

Guidance:

Adequate roadway capacity should be provided at a signalized location. Before an intersection is widened, the additional green time pedestrians need to cross the widened roadways should be considered to ensure that it will not exceed the green time saved through improved vehicular flow.

CHAPTER 4C. TRAFFIC CONTROL SIGNAL NEEDS STUDIES

Section 4C.01 Studies and Factors for Justifying Traffic Control Signals

Standard:

An engineering study of traffic conditions, pedestrian characteristics, and physical characteristics of the location shall be performed to determine whether installation of a traffic control signal is justified at a particular location.

The investigation of the need for a traffic control signal shall include an analysis of the applicable factors contained in the following traffic signal warrants and other factors related to existing operation and safety at the study location:

Warrant 1, Eight-Hour Vehicular Volume.

Warrant 2, Four-Hour Vehicular Volume.

Warrant 3, Peak Hour.

Warrant 4, Pedestrian Volume.

Warrant 5, School Crossing.

Warrant 6, Coordinated Signal System.

Warrant 7, Crash Experience.

Warrant 8, Roadway Network.

The satisfaction of a traffic signal warrant or warrants shall not in itself require the installation of a traffic control signal.

Support:

Sections 8D.07 and 10D.05 contain information regarding the use of traffic control signals instead of gates and/or flashing light signals at highway-railroad grade crossings and highway-LRT grade crossings, respectively.

Guidance:

A traffic control signal should not be installed unless one or more of the factors described in this section are met.

A traffic control signal should not be installed unless an engineering study indicates that installing a traffic control signal will improve the overall safety and/or operation of the intersection.

A traffic control signal should not be installed if it will seriously disrupt progressive traffic flow.

The study should consider the effects of the right-turn vehicles from the minor-street

approaches. Engineering judgment should be used to determine what, if any, portion of the right-turn traffic is subtracted from the minor-street traffic count when evaluating the count against the above signal warrants.

Engineering judgment should also be used in applying various traffic signal warrants to cases where approaches consist of one lane plus one left-turn or right-turn lane. The site-specific traffic characteristics dictate whether an approach should be considered as one lane or two lanes. For example, for an approach with one lane for through and right-turning traffic plus a left-turn lane, engineering judgment could indicate that it should be considered a one-lane approach if the traffic using the left-turn lane is minor. In such a case, the total traffic volume approaching the intersection should be applied against the signal warrants as a one-lane approach. The approach should be considered two lanes if approximately half of the traffic on the approach turns left and the left-turn lane is of sufficient length to accommodate all left-turn vehicles.

Similar engineering judgment and rationale should be applied to a street approach with one lane plus a right-turn lane. In this case, the degree of conflict of minor-street right-turn traffic with traffic on the major street should be considered. Thus, right-turn traffic should not be included in the minor-street volume if the movement enters the major street with minimal conflict. The approach should be evaluated as a one-lane approach with only the traffic volume in the through/left-turn lane considered.

At a location that is under development or construction and where it is not possible to obtain a traffic count that would represent future traffic conditions, hourly volumes should be estimated as part of an engineering study for comparison with traffic signal warrants.

For signal warrant analysis, a location with a wide median should be considered as one intersection.

Option:

Engineering study data may include the following:

- A. The number of vehicles entering the intersection in each hour from each approach during 12 hours of an average day. It is desirable that the hours selected contain the greatest percentage of the 24-hour traffic volume.
- B. Vehicular volumes for each traffic movement from each approach, classified by vehicle type (heavy trucks, passenger cars and light trucks, public-transit vehicles, and, in some locations, bicycles), during each 15-minute period of the 2 hours in the morning and 2 hours in the afternoon during which total traffic entering the intersection is greatest.
- C. Pedestrian volume counts on each crosswalk during the same periods as the vehicular counts in Paragraph B above and during hours of highest pedestrian volume. Where young, elderly, and/or persons with physical or visual disabilities need special

consideration, the pedestrians and their crossing times may be classified by general observation.

- D. Information about nearby facilities and activity centers that serve the young, elderly, and/or persons with disabilities, including requests from persons with disabilities for accessible crossing improvements at the location under study. These persons may not be adequately reflected in the pedestrian volume count if the absence of a signal restrains their mobility.
- E. The posted or statutory speed limit or the 85th-percentile speed on the uncontrolled approaches to the location.
- F. A condition diagram showing details of the physical layout, including such features as intersection geometrics, channelization, grades, sight-distance restrictions, transit stops and routes, parking conditions, pavement markings, roadway lighting, driveways, nearby railroad crossings, distance to nearest traffic control signals, utility poles and fixtures, and adjacent land use.
- G. A collision diagram showing crash experience by type, location, direction of movement, severity, weather, time of day, date, and day of week for at least 1 year.

The following data, which are desirable for a more precise understanding of the operation of the intersection, may be obtained during the periods specified in Paragraph B above:

- A. Vehicle-hours of stopped time delay determined separately for each approach to be consistent with the Peak Hour Warrant.
- B. The number and distribution of acceptable gaps in vehicular traffic on the major street for entrance from the minor street.
- C. The posted or statutory speed limit or the 85th-percentile speed on controlled approaches at a point near to the intersection but unaffected by the control.
- D. Pedestrian delay time for at least two 30-minute peak pedestrian delay periods of an average weekday or like periods of a Saturday or Sunday.
- E. Queue length on stop-controlled approaches.

Section 4C.02 Warrant 1, Eight-Hour Vehicular Volume

Support:

The Minimum Vehicular Volume, Condition A, is intended for application where a large volume of intersecting traffic is the principal reason to consider installing a traffic control signal.

The Interruption of Continuous Traffic, Condition B, is intended for application where the traffic volume on a major street is so heavy that traffic on a minor intersecting street suffers excessive delay or conflict in entering or crossing the major street.

Standard:

The need for a traffic control signal shall be considered if an engineering study finds that one of the following conditions exist for each of any 8 hours of an average day:

- A. The vehicles per hour given in both of the 100% columns of Condition A in Table 4C-1 exist on the major street and on the higher volume minor-street approaches, respectively, to the intersection, or
- B. The vehicles per hour given in both of the 100% columns of Condition B in Table 4C-1 exist on the major street and on the higher volume minor-street approaches, respectively, to the intersection.

In applying each condition the major street and minor-street volumes shall be for the same 8 hours. On the minor street, the higher volume shall not be required to be on the same approach during each of these 8 hours.

Option:

If the posted or statutory speed limit or the 85th-percentile speed on the major street exceeds 70 km/h (40 mph), or if the intersection lies within the built-up area of an isolated community having a population of less than 10,000, the traffic volumes in the 70% columns in Table 4C-1 may be used in place of the 100% columns.

Standard:

The need for a traffic control signal shall be considered if an engineering study finds that both of the following conditions exist for each of any 8 hours of an average day:

- A. The vehicles per hour given in both of the 80% columns of Condition A in Table 4C-1 exist on the major street and on the higher volume minor-street approaches, respectively, to the intersection, and
- B. The vehicles per hour given in both of the 80% columns of Condition B in Table 4C-1 exist on the major street and on the higher volume minor-street approaches, respectively, to the intersection.

These major street and minor-street volumes shall be for the same 8 hours for each condition; however, the 8 hours satisfied in Condition A shall not be required to be the same 8 hours satisfied in Condition B. On the minor street the higher volume shall not be required to be on the same approach during each of the 8 hours.

Table 4C-1. Warrant 1, Eight-Hour Vehicular Volume

Condition A - Minimum Vehicular Volume								
Number of lanes for moving traffic on each approach		Vehicles per hour on major street (total of both approaches)			Vehicles per hour on higher-volume minor-street approach (one direction only)			
Major Street	Minor Street	100% ^a	80% ^b	70% ^c	100% ^a	80% ^b	70% ^c	
1.....	1.....	500	400	350	150	120	105	
2 or more...	1.....	600	480	420	150	120	105	
2 or more...	2 or more ...	600	480	420	200	160	140	
1.....	2 or more	500	400	350	200	160	140	

Condition B - Interruption of Continuous Traffic								
Number of lanes for moving traffic on each approach		Vehicles per hour on major street (total of both approaches)			Vehicles per hour on higher-volume minor-street approach (one direction only)			
Major Street	Minor Street	100% ^a	80% ^b	70% ^c	100% ^a	80% ^b	70% ^c	
1.....	1.....	750	600	525	75	60	53	
2 or more...	1.....	900	720	630	75	60	53	
2 or more...	2 or more ...	900	720	630	100	80	70	
1.....	2 or more	750	600	525	100	80	70	

^a Basic minimum hourly volume.

^b Used for combination of Conditions A and B after adequate trial of other remedial measures.

^c May be used when the major street speed exceeds 70 km/h (40 mph) or in an isolated community with a population of less than 10,000.

Guidance:

The combination of Conditions A and B should be applied only after an adequate trial of other alternatives that could cause less delay and inconvenience to traffic has failed to solve the traffic problems.

Section 4C.03 Warrant 2, Four-Hour Vehicular Volume**Support:**

The Four-Hour Vehicular Volume signal warrant conditions are intended to be applied where the volume of intersecting traffic is the principal reason to consider installing a traffic control signal.

Standard:

The need for a traffic control signal shall be considered if an engineering study finds that for each of any 4 hours of an average day, the plotted points representing the vehicles per hour on the major street (total of both approaches) and the corresponding vehicles per hour on the higher volume minor-street approach (one direction only) all fall above the applicable curve in Figure 4C-1 for the existing combination of approach lanes. On the minor street, the higher volume shall not be required to be on the same approach during each of these 4 hours.

Option:

If the posted or statutory speed limit or the 85th-percentile speed on the major street exceeds 70 km/h (40 mph), or if the intersection lies within the built-up area of an isolated community having a population of less than 10,000, Figure 4C-2 may be used in place of Figure 4C-1.

Section 4C.04 Warrant 3, Peak Hour**Support:**

The Peak Hour signal warrant is intended for use at a location where traffic conditions are such that for a minimum of 1 hour of an average day, the minor-street traffic suffers undue delay when entering or crossing the major street.

Standard:

This signal warrant shall be applied only in unusual cases. Such cases include, but are not limited to, office complexes, manufacturing plants, industrial complexes, or high-occupancy vehicle facilities that attract or discharge large numbers of vehicles over a short time.

Figure 4C-1. Warrant 2 - Four-Hour Vehicular Volume

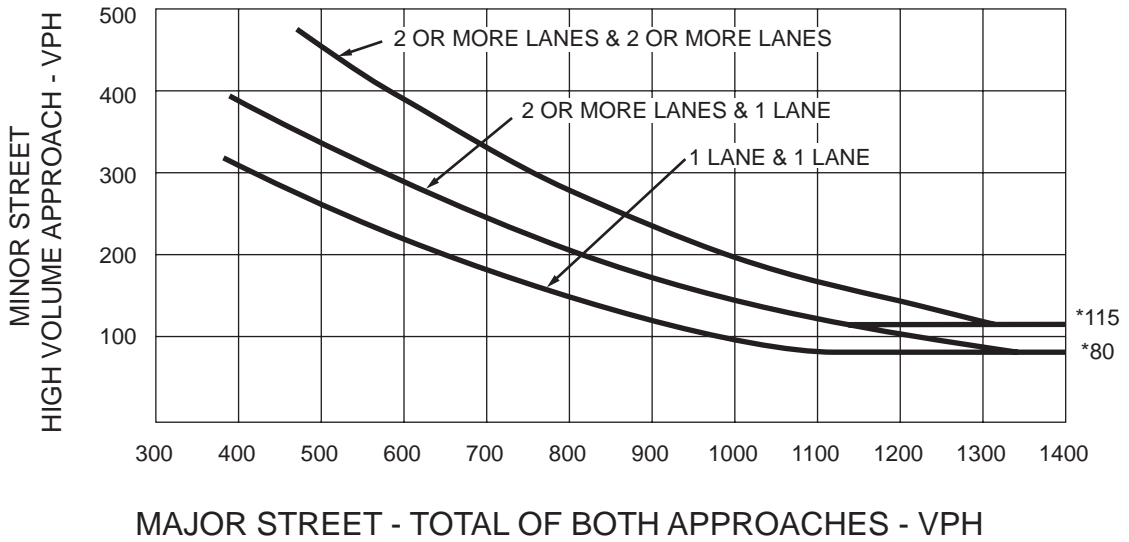

*Note: 115 vph applies as the lower threshold volume for a minor street approach with two or more lanes and 80 vph applies as the lower threshold volume for a minor street approach with one lane.

Figure 4C-2. Warrant 2 - Four-Hour Vehicular Volume (70% Factor)
 (COMMUNITY LESS THAN 10,000 POPULATION OR ABOVE 70 km/h (40 mph) ON MAJOR STREET)

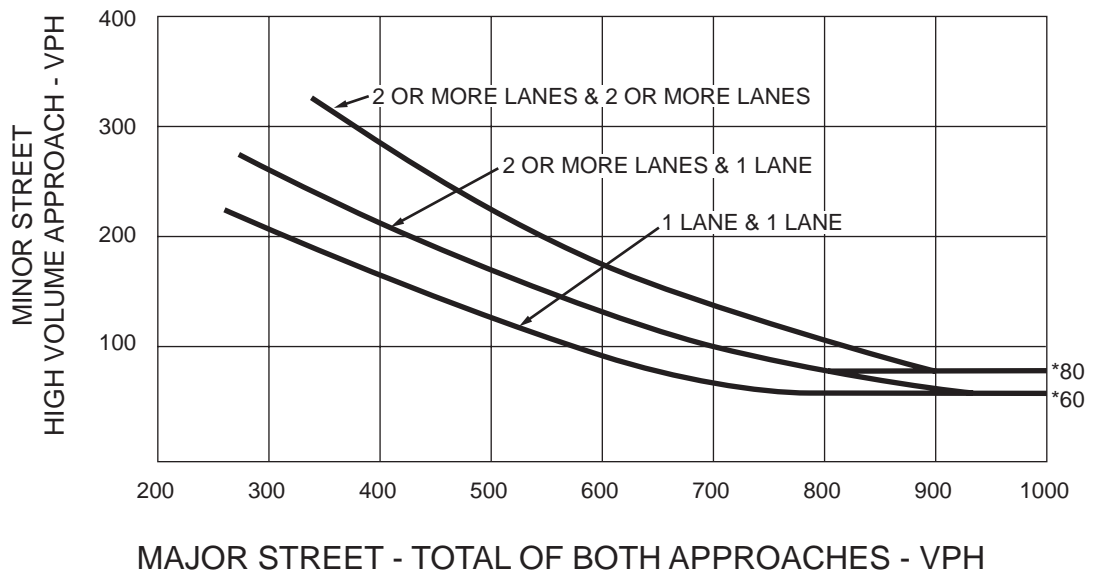

*Note: 80 vph applies as the lower threshold volume for a minor street approach with two or more lanes and 60 vph applies as the lower threshold volume for a minor street approach with one lane.

The need for a traffic control signal shall be considered if an engineering study finds that the criteria in either of the following two categories are met:

- A. If all three of the following conditions exist for the same 1 hour (any four consecutive 15-minute periods) of an average day:**
- 1. The total stopped time delay experienced by the traffic on one minor-street approach (one direction only) controlled by a STOP sign equals or exceeds: 4 vehicle-hours for a one-lane approach; or 5 vehicle-hours for a two-lane approach, and**
 - 2. The volume on the same minor-street approach (one direction only) equals or exceeds 100 vehicles per hour for one moving lane of traffic or 150 vehicles per hour for two moving lanes, and**
 - 3. The total entering volume serviced during the hour equals or exceeds 650 vehicles per hour for intersections with three approaches or 800 vehicles per hour for intersections with four or more approaches.**
- B. The plotted point representing the vehicles per hour on the major street (total of both approaches) and the corresponding vehicles per hour on the higher-volume minor-street approach (one direction only) for 1 hour (any four consecutive 15-minute periods) of an average day falls above the applicable curve in Figure 4C-3 for the existing combination of approach lanes.**

Option:

If the posted or statutory speed limit or the 85th-percentile speed on the major street exceeds 70 km/h (40 mph), or if the intersection lies within the built-up area of an isolated community having a population of less than 10,000, Figure 4C-4 may be used in place of Figure 4C-3 to satisfy the criteria in the second category of the Standard.

4C.05 Warrant 4, Pedestrian Volume

Support:

The Pedestrian Volume signal warrant is intended for application where the traffic volume on a major street is so heavy that pedestrians experience excessive delay in crossing the major street.

Figure 4C-3. Warrant 3 - Peak Hour

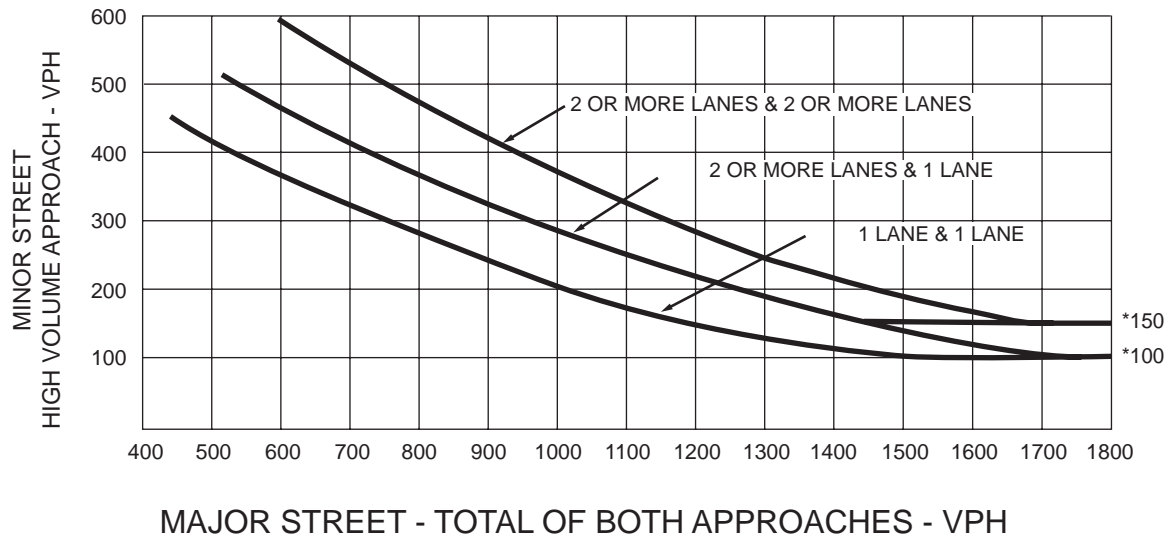

*Note: 150 vph applies as the lower threshold volume for a minor street approach with two or more lanes and 100 vph applies as the lower threshold volume for a minor street approach with one lane.

Figure 4C-4. Warrant 3 - Peak Hour (70% Factor)
(COMMUNITY LESS THAN 10,000 POPULATION OR ABOVE 70 km/h (40 mph) ON MAJOR STREET)

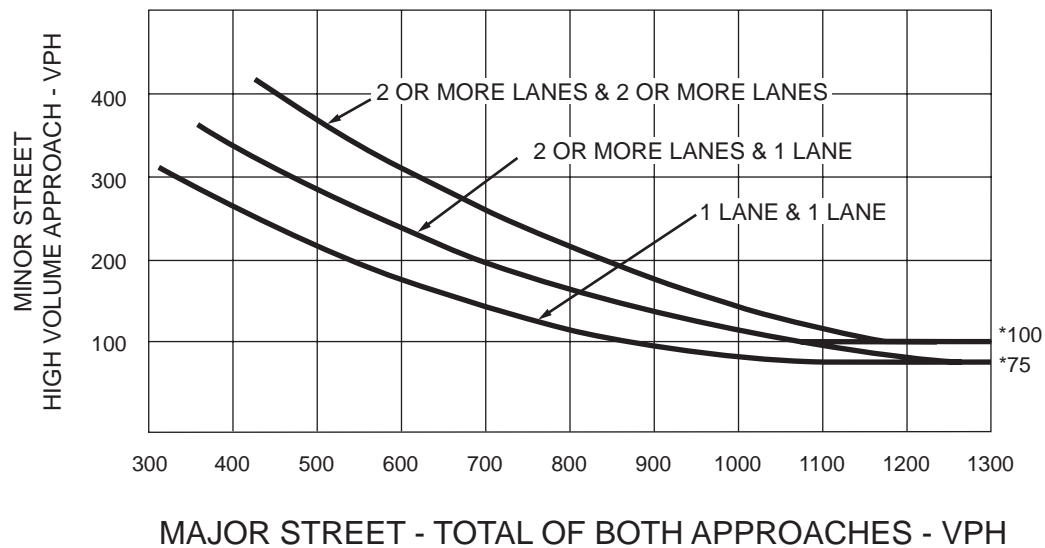

*Note: 100 vph applies as the lower threshold volume for a minor street approach with two or more lanes and 75 vph applies as the lower threshold volume for a minor street approach with one lane.

Standard:

The need for a traffic control signal at an intersection or mid-block crossing shall be considered if an engineering study finds that both of the following criteria are met:

- A. The pedestrian volume crossing the major street at an intersection or mid-block location during an average day is 100 or more for each of any 4 hours or 190 or more during any 1 hour, and**
- B. There are fewer than 60 gaps per hour in the traffic stream of adequate length to allow pedestrians to cross during the same period when the pedestrian volume criterion is satisfied. Where there is a divided street having a median of sufficient width for pedestrians to wait, the requirement applies separately to each direction of vehicular traffic.**

The Pedestrian Volume signal warrant shall not be applied at locations where the distance to the nearest traffic control signal along the major street is less than 90 m (300 ft), unless the proposed traffic control signal will not restrict the progressive movement of traffic.

If a traffic control signal is justified by both this signal warrant and a traffic engineering study, the traffic control signal shall be equipped with pedestrian signal heads conforming to requirements set forth in Chapter 4E.

Guidance:

If a traffic control signal is justified by both this signal warrant and a traffic engineering study:

- A. If installed within a signal system, the traffic control signal should be coordinated.**
- B. At an intersection, the traffic control signal should be traffic-actuated and should include pedestrian detectors. As a minimum, it should have semi-actuated operation, but full-actuated operation with detectors on all approaches might also be appropriate.**
- C. At non-intersection crossings, the traffic control signal should be pedestrian-actuated, parking and other sight obstructions should be prohibited for at least 30 m (100 ft) in advance of and at least 6.1 m (20 ft) beyond the crosswalk, and the installation should include suitable standard signs and pavement markings.**

Option:

The criterion for the pedestrian volume crossing the major roadway may be reduced as much as 50 percent if the average crossing speed of pedestrians is less than 1.2 m/sec (4 ft/sec).

A traffic control signal may not be needed at the study location if adjacent coordinated traffic control signals consistently provide gaps of adequate length for pedestrians to cross the street, even if the rate of gap occurrence is less than one per minute.

Section 4C.06 Warrant 5, School Crossing**Support:**

The School Crossing signal warrant is intended for application where the fact that school children cross the major street is the principal reason to consider installing a traffic control signal.

Standard:

The need for a traffic control signal shall be considered when an engineering study of the frequency and adequacy of gaps in the vehicular traffic stream as related to the number and size of groups of school children at an established school crossing across the major street shows that the number of adequate gaps in the traffic stream during the period when the children are using the crossing is less than the number of minutes in the same period (see Section 7A.03) and there are a minimum of 20 students during the highest crossing hour.

Before a decision is made to install a traffic control signal, consideration shall be given to the implementation of other remedial measures, such as warning signs and flashers, school speed zones, school crossing guards, or a grade-separated crossing.

The School Crossing signal warrant shall not be applied at locations where the distance to the nearest traffic control signal along the major street is less than 90 m (300 ft), unless the proposed traffic control signal will not restrict the progressive movement of traffic.

Guidance:

If a traffic control signal is justified by both this signal warrant and an engineering study:

- A. If installed within a signal system, the traffic control signal should be coordinated.

- B. At an intersection, the traffic control signal should be traffic-actuated and should include pedestrian detectors. As a minimum, it should have semi-actuated operation, but full-actuated operation with detectors on all approaches might also be appropriate.
- C. At non-intersection crossings, the traffic control signal should be pedestrian-actuated, parking and other sight obstructions should be prohibited for at least 30 m (100 ft) in advance of and at least 6.1 m (20 ft) beyond the crosswalk, and the installation should include suitable standard signs and pavement markings.

Section 4C.07 Warrant 6, Coordinated Signal System

Support:

Progressive movement in a coordinated signal system sometimes necessitates installing traffic control signals at intersections where they would not otherwise be needed in order to maintain proper platooning of vehicles.

Standard:

The need for a traffic control signal shall be considered if an engineering study finds that one of the following criteria is met:

- A. On a one-way street or a street that has traffic predominantly in one direction, the adjacent traffic control signals are so far apart that they do not provide the necessary degree of vehicular platooning.**
- B. On a two-way street, adjacent traffic control signals do not provide the necessary degree of platooning and the proposed and adjacent traffic control signals will collectively provide a progressive operation.**

Guidance:

The Coordinated Signal System signal warrant should not be applied where the resultant spacing of traffic control signals would be less than 300 m (1,000 ft).

Section 4C.08 Warrant 7, Crash Experience

Support:

The Crash Experience signal warrant conditions are intended for application where the severity and frequency of crashes are the principal reasons to consider installing a traffic control signal.

Standard:

The need for a traffic control signal shall be considered if an engineering study finds that all of the following criteria are met:

- A. Adequate trial of alternatives with satisfactory observance and enforcement has failed to reduce the crash frequency, and
- B. Five or more reported crashes, of types susceptible to correction by a traffic control signal, have occurred within a 12-month period, each crash involving personal injury or property damage apparently exceeding the applicable requirements for a reportable crash, and
- C. For each of any 8 hours of an average day, the vehicles per hour (vph) given in both of the 80% columns of Condition A in Table 4C-1 (see Section 4C.02), or the vph in both of the 80% columns of Condition B in Table 4C-1 exists on the major street and on the higher-volume minor-street approach, respectively, to the intersection, or the volume of pedestrian traffic is not less than 80 percent of the requirements specified in the Pedestrian Volume warrant. These major-street and minor-street volumes shall be for the same 8 hours. On the minor street, the higher volume shall not be required to be on the same approach during each of the 8 hours.

Section 4C.09 Warrant 8, Roadway Network**Support:**

Installing a traffic control signal at some intersections might be justified to encourage concentration and organization of traffic flow on a roadway network.

Standard:

The need for a traffic control signal shall be considered if an engineering study finds that the common intersection of two or more major routes meets one or both of the following criteria:

- A. The intersection has a total existing, or immediately projected, entering volume of at least 1,000 vehicles per hour during the peak hour of a typical weekday and has 5-year projected traffic volumes, based on an engineering study, that meet one or more of Warrants 1, 2, and 3 during an average weekday, or

- B. The intersection has a total existing or immediately projected entering volume of at least 1,000 vehicles per hour for each of any 5 hours of a non-normal business day (Saturday or Sunday).**

A major route as used in this signal warrant shall have one or more of the following characteristics:

- A. It is part of the street or highway system that serves as the principal roadway network for through traffic flow, or**
- B. It includes rural or suburban highways outside, entering, or traversing a city, or**
- C. It appears as a major route on an official plan, such as a major street plan in an urban area traffic and transportation study.**

CHAPTER 4D. TRAFFIC CONTROL SIGNAL FEATURES

Section 4D.01 General

Support:

The features of traffic control signals of interest to road users are the location, design, and meaning of the signal indications. Uniformity in the design features that affect the traffic to be controlled, as set forth in this Manual, is especially important for safe and efficient traffic operations.

Pavement markings (see Part 3) that clearly communicate the operational plan of an intersection to road users play an important role in the effective operation of traffic control signals. By designating the number of lanes, the use of each lane, the length of additional lanes on the approach to an intersection, and the proper stopping points, the engineer can design the signal phasing and timing to best match the goals of the operational plan.

Standard:

A traffic control signal shall be operated in either a steady (stop-and-go) mode or a flashing mode at all times.

A traffic control signal shall control traffic only at the intersection or mid-block location where the signal faces are placed.

STOP signs shall not be used in conjunction with any traffic control signal operation, except in either of the following cases:

- A. If the signal indication for an approach is a flashing red at all times.**
- B. If a minor street or driveway is located within or adjacent to the area controlled by the traffic control signal, but does not require separate traffic signal control because an extremely low potential for conflict exists.**

When a traffic control signal is not in operation, such as before it is placed in service, during seasonal shutdowns, or when it is not desirable to operate the traffic control signal, the signal faces shall be covered, turned, or taken down to clearly indicate that the traffic control signal is not in operation.

Guidance:

Pavement markings should be used at traffic control signal locations as provided in Part 3. If the road surface will not retain pavement markings, signs should be installed to provide the needed road user information.

Engineering judgment should be used to determine the proper phasing and timing for a traffic control signal. Since traffic flows and patterns change, phasing and timing should be re-evaluated regularly and updated if needed.

Section 4D.02 Responsibility For Operation and Maintenance

Guidance:

Prior to installing any traffic control signal, the responsibility for the maintenance of the signal and all of the appurtenances, hardware, software, and the timing plan(s) should be clearly established. The responsible agency should provide for the maintenance of the traffic control signal and all of its appurtenances in a competent manner.

To this end the agency should:

- A. Keep every controller assembly in effective operation in accordance with its predetermined timing schedule; check the operation of the controller assembly frequently enough to ensure that it is operating in accordance with the predetermined timing schedule; and ensure that a record of all timing changes is maintained and that only authorized persons make timing changes.
- B. Clean the optical system of the signal sections and replace the light sources as frequently as experience proves necessary.
- C. Clean and service equipment and other appurtenances as frequently as experience proves necessary.
- D. Provide for alternate operation of the traffic control signal during a period of failure, using flashing mode or manual control, or manual traffic direction by proper authorities as might be required by traffic volumes or congestion, or by erecting other traffic control devices.
- E. Have properly skilled maintenance personnel available without undue delay for all emergency and lamp failure calls.
- F. Provide spare equipment to minimize the interruption of traffic control signal operation as a result of equipment failure.
- G. Provide for the availability of properly-skilled maintenance personnel for the repair of all components.
- H. Maintain the appearance of the signal displays and equipment.

Section 4D.03 Provisions for Pedestrians

Support:

Chapter 4E contains additional information regarding pedestrian signals.

Standard:

The design and operation of traffic control signals shall take into consideration the needs of pedestrian as well as vehicular traffic.

If engineering judgment indicates the need for provisions for a given pedestrian movement, signal faces conveniently visible to pedestrians shall be provided by pedestrian signal heads or a signal face for an adjacent vehicular movement.

Guidance:

Safety considerations should include the installation, where appropriate, of accessible pedestrian signals (see Sections 4E.06 and 4E.08) that provide information in non-visual format (such as audible tones, verbal messages, and/or vibrating surfaces).

Where pedestrian movements regularly occur, pedestrians should be provided with sufficient time to cross the roadway by adjusting the traffic control signal operation and timing to provide sufficient crossing time every cycle or by providing pedestrian detectors.

Option:

If it is desirable to prohibit certain pedestrian movements at a traffic control signal, a PEDESTRIANS PROHIBITED (R9-3) or No Pedestrian Crossing (R9-3a) sign may be used (see Section 2B.39).

Section 4D.04 Meaning of Vehicular Signal Indications

Support:

The "Uniform Vehicle Code" (see Section 1A.11) is the primary source for the standards for the meaning of vehicular signal indications to both vehicle operators and pedestrians as set forth below, and the standards for the meaning of separate pedestrian signal indications as set forth in Section 4E.02.

Standard:

Unless otherwise determined by law, the following meanings shall be given to highway traffic signal indications for vehicles and pedestrians:

A. Steady green signal indications shall have the following meanings:

- 1. Traffic, except pedestrians, facing a CIRCULAR GREEN signal indication may proceed straight through or turn right or left except as such movement is modified by lane-use signs, turn prohibition signs, lane markings, or roadway design. But vehicular traffic, including vehicles turning right or left, shall yield the right-of-way to other vehicles, and to pedestrians lawfully within the intersection or an adjacent crosswalk, at the time such signal indication is exhibited.**
- 2. Traffic, except pedestrians, facing a GREEN ARROW signal indication, shown alone or in combination with another signal indication, may cautiously enter the intersection only to make the movement indicated by such arrow, or such other movement as is permitted by other signal indications shown at the same time. Such vehicular traffic shall yield the right-of-way to pedestrians lawfully within an adjacent crosswalk and to other traffic lawfully using the intersection.**
- 3. Unless otherwise directed by a pedestrian signal head, pedestrians facing any green signal indication, except when the signal indication is a turn arrow for a vehicular movement in conflict with the desired path of the pedestrian, may proceed across the roadway within any marked or unmarked crosswalk.**

B. Steady yellow signal indications shall have the following meanings:

- 1. Traffic, except pedestrians, facing a steady CIRCULAR YELLOW or YELLOW ARROW signal indication is thereby warned that the related green movement is being terminated or that a red signal indication will be exhibited immediately thereafter when vehicular traffic shall not enter the intersection.**
- 2. Pedestrians facing a steady CIRCULAR YELLOW or YELLOW ARROW signal indication, unless otherwise directed by a pedestrian signal head, are thereby advised that there is insufficient time to cross the roadway before a red signal indication is shown, and no pedestrian shall then start to cross the roadway.**

C. Steady red signal indications shall have the following meanings:

- 1. Vehicular traffic facing a steady CIRCULAR RED signal indication alone shall stop at a clearly marked stop line, but if there is no stop line, traffic shall stop before entering the crosswalk on the near side of the intersection; or if there is no crosswalk, then before entering the**

intersection, and shall remain stopped until a signal indication to proceed is shown, or as provided below.

Except when a sign is in place prohibiting a turn on red or a RED ARROW signal indication is displayed, vehicular traffic facing a CIRCULAR RED signal indication may enter the intersection to turn right, or to turn left from a one-way street into a one-way street, after stopping. Such vehicular traffic shall yield the right-of-way to pedestrians lawfully within an adjacent crosswalk and to other traffic lawfully using the intersection.

2. Vehicular traffic facing a steady RED ARROW signal indication shall not enter the intersection to make the movement indicated by the arrow (except as described in the Option below) and, unless entering the intersection to make another movement permitted by another signal indication, shall stop at a clearly-marked stop line; but if there is no stop line, before entering the crosswalk on the near side of the intersection, or if there is no crosswalk, then before entering the intersection, and shall remain stopped until a signal indication permitting the movement indicated by such RED ARROW is shown.
3. Unless otherwise directed by a pedestrian signal head, pedestrians facing a steady CIRCULAR RED or RED ARROW signal indication alone shall not enter the roadway.

D. Flashing signal indications shall have the following meanings:

1. Flashing yellow - When a yellow lens is illuminated with rapid intermittent flashes, vehicular traffic may proceed through the intersection or past such signal indication only with caution.
2. Flashing red - When a red lens is illuminated with rapid intermittent flashes, vehicular traffic shall stop at a clearly-marked stop line, but if there is no stop line, traffic shall stop before entering the crosswalk on the near side of the intersection; or if there is no crosswalk, at the point nearest the intersecting roadway where the driver has a view of approaching traffic on the intersecting roadway before entering the intersection. The right to proceed shall be subject to the rules applicable after making a stop at a STOP sign.
3. Flashing RED ARROW and flashing YELLOW ARROW signal indications have the same meaning as the corresponding flashing circular signal indication, except that they apply only to vehicular traffic intending to make the movement indicated by the arrow.

Option:

Where turns are allowed on red and the signal indication is an arrow, a sign may be used to indicate that turns are allowed on red after stopping.

Section 4D.05 Application of Steady Signal Indications

Standard:

When a traffic control signal is being operated in a steady (stop-and-go) mode, at least one lens in each signal face shall be illuminated at any given time.

A signal face(s) that controls a particular vehicular movement during any interval of a cycle shall control that same movement during all intervals of the cycle.

Steady signal indications shall be applied as follows:

A. A steady CIRCULAR RED signal indication:

- 1. Shall be displayed when it is intended to prohibit traffic, except pedestrians directed by a pedestrian signal head, from entering the intersection or other controlled area. Turning after stopping is permitted as stated in Section 4D.04(C)(1).**
- 2. Shall be displayed with the appropriate GREEN ARROW signal indications when it is intended to permit traffic to make a specified turn or turns, and to prohibit traffic from proceeding straight ahead through the intersection or other controlled area, except in protected only mode turn signal faces.**

B. A steady CIRCULAR YELLOW signal indication:

- 1. Shall be displayed following a CIRCULAR GREEN or straight-through GREEN ARROW signal indication in the same signal face.**
- 2. Shall not be displayed in conjunction with the change from the CIRCULAR RED signal indication to the CIRCULAR GREEN signal indication.**
- 3. Shall be followed by a CIRCULAR RED signal indication except that, when entering preemption operation, the return to the previous CIRCULAR GREEN signal indication shall be permitted following a CIRCULAR YELLOW signal indication (see Section 4D.13).**

- C. A steady CIRCULAR GREEN signal indication shall be displayed only when it is intended to permit traffic to proceed in any direction that is lawful and practical.**
- D. A steady RED ARROW signal indication shall be displayed when it is intended to prohibit traffic, except pedestrians directed by a pedestrian signal head, from entering the intersection or other controlled area to make the indicated turn. Turning on a steady RED ARROW signal indication shall not be permitted.**
- E. A steady YELLOW ARROW signal indication:**
- 1. Shall be displayed in the same direction as a GREEN ARROW signal indication following a GREEN ARROW signal indication in the same signal face, unless:**
 - (a) The GREEN ARROW signal indication and a CIRCULAR GREEN (or straight-through GREEN ARROW) signal indication terminate simultaneously in the same signal face, or**
 - (b) The green arrow is a straight-through GREEN ARROW.**
 - 2. Shall not be displayed in conjunction with the change from a RED ARROW signal indication to a GREEN ARROW signal indication.**
 - 3. Shall not be displayed when any conflicting vehicular movement has a green or yellow signal indication or any conflicting pedestrian movement has a WALKING PERSON (symbolizing WALK) or flashing UPRAISED HAND (symbolizing DONT WALK) signal indication (see Section 4D.09).**
 - 4. Shall be terminated by a RED ARROW signal indication for the same direction or a CIRCULAR RED signal indication except:**
 - (a) When entering preemption operation, the return to the previous GREEN ARROW signal indication shall be permitted following a YELLOW ARROW signal indication.**
 - (b) When the movement controlled by the arrow is to continue on a permissive mode basis during an immediately-following CIRCULAR GREEN signal indication.**
- F. A steady GREEN ARROW signal indication:**
- 1. Shall be displayed only to allow vehicular movements, in the direction indicated, that are not in conflict with other vehicles moving on a green**

- or yellow signal indication or with pedestrians crossing in conformance with a WALKING PERSON (symbolizing WALK) or flashing UPRAISED HAND (symbolizing DONT WALK) signal indication (see Section 4D.09).**
- 2. Shall be displayed on a signal face that controls a left-turn movement when said movement is not in conflict with other vehicles moving on a green or yellow signal indication or with pedestrians crossing in conformance with a WALKING PERSON (symbolizing WALK) or flashing UPRAISED HAND (symbolizing DONT WALK) signal indication (see Section 4D.09).**
 - 3. Shall not be required on the stem of T-intersections or for turns from one-way streets.**

Option:

Steady RED ARROW, YELLOW ARROW, and GREEN ARROW signal indications, if not otherwise prohibited, may be used instead of the corresponding circular signal indications at the following locations:

- A. On an approach intersecting a one-way street.
- B. Where certain movements are prohibited.
- C. Where certain movements are physically impossible.

Section 4D.06 Application of Steady Signal Indications For Left Turns

Support:

Left-turning traffic is controlled by one of four modes as follows:

- A. Permissive Only Mode - turns made on the CIRCULAR GREEN signal indication after yielding to oncoming traffic and pedestrians.
- B. Protected Only Mode - turns made only when the left-turn GREEN ARROW signal indication is displayed.
- C. Protected/Permissive Mode - both modes occur on an approach during the same cycle.
- D. Variable Left-Turn Mode - the operating mode changes among the protected only mode and/or the protected/permissive mode and/or the permissive only mode during different periods of the day.

Option:

In areas having a high percentage of elderly drivers, special consideration may be given to the use of protected only mode left-turn phasing, when appropriate.

Standard:

The required left-turn signal faces and operation for an approach shall be determined by the selected mode of left-turn operation, as follows:

- A. Permissive Only Mode - The signal indication for permissive only mode left turns shall be the same color as the signal indication for through traffic. A separate signal indication or signal face for left turns shall not be required.**
- B. Protected Only Mode - The left-turn signal face shall be capable of displaying one the following sets of signal indications:**
 - 1. Left-turn RED ARROW, YELLOW ARROW, and GREEN ARROW signal indications only. At least one left-turn signal face shall be provided in addition to the two approach signal faces required in Section 4D.15 for the through movement. Only one of the three colors shall be illuminated at any given time. A signal instruction sign shall not be required with this set of signal indications. If used, it shall be a LEFT ON GREEN ARROW ONLY sign (R10-5); or**
 - 2. CIRCULAR RED, left-turn YELLOW ARROW, and left-turn GREEN ARROW signal indications. At least one left-turn signal face shall be provided in addition to the two approach signal faces required in Section 4D.15 for the through movement. Only one of the three colors shall be illuminated at any given time. Unless the CIRCULAR RED signal indication is shielded, hooded, louvered, positioned, or designed such that it cannot be seen by drivers in the through lane(s), either a LEFT TURN SIGNAL sign (R10-10) or a visibility-limited CIRCULAR RED signal indication shall be used.**
 - 3. CIRCULAR RED, CIRCULAR YELLOW, CIRCULAR GREEN, and left-turn GREEN ARROW signal indications. This four-section signal face shall be used only when the CIRCULAR GREEN and left-turn GREEN ARROW signal indications begin and terminate together. During each interval, the circular signal indication shall be the same color as the signal indication on the signal face(s) for the adjacent through traffic.**
- C. Protected/Permissive Mode - The signal indications for protected/permissive mode left turns shall be provided either in a shared signal face (to be shared**

by left-turning and through traffic) or in a separate signal face intended to be exclusively used by left-turning traffic.

If a shared signal face is provided, it shall be considered an approach signal face, and shall meet the following requirements:

1. During the protected left-turn movement, the signal face shall simultaneously display:
 - (a) A left-turn GREEN ARROW signal indication, and
 - (b) A circular signal indication that is the same color as the signal indication for the adjacent through lane on the same approach as the protected left turn.

During the protected left-turn movement, the signal faces for through traffic on the opposing approach shall simultaneously display CIRCULAR RED signal indications.

2. During the permissive left-turn movement, all signal faces on the approach shall display CIRCULAR GREEN signal indications.
3. All signal faces on the approach shall simultaneously display the same color of circular signal indications to both through and left-turn road users.
4. A supplementary sign shall not be required. If used, it shall be a LEFT TURN YIELD ON GREEN (symbolic green ball) sign (R10-12).

If a separate signal face is provided, it shall be considered a left-turn signal face, and shall meet the following requirements:

1. During the protected left-turn movement, the left-turn signal face shall simultaneously display:
 - (a) A left-turn GREEN ARROW signal indication, and
 - (b) A CIRCULAR RED signal indication.

During the protected left-turn movement, the signal faces for through traffic on the opposing approach shall simultaneously display CIRCULAR RED signal indications.

2. During the permissive left-turn movement, the left-turn signal face shall display a CIRCULAR GREEN signal indication.

3. If the **CIRCULAR GREEN** and **CIRCULAR YELLOW** signal indications in the left-turn signal face are visibility-limited from the adjacent through movement, the left-turn signal face shall not be required to simultaneously display the same color of circular signal indication as the signal faces for the adjacent through movement.
4. If the **CIRCULAR GREEN** and **CIRCULAR YELLOW** signal indications in the left-turn signal face are visibility-limited from the adjacent through movement, the display of a **CIRCULAR GREEN** signal indication for a permissive left-turn movement while the signal faces for the adjacent through movement display **CIRCULAR RED** signal indications and the opposing left-turn signal face displays a left-turn **GREEN ARROW** for a protected left-turn movement shall be permitted.
5. If the left-turn signal face does not simultaneously display the same color of circular signal indication as the signal faces for the adjacent through movement, a combination of a **LEFT TURN SIGNAL** sign (R10-11) and a **LEFT TURN YIELD ON GREEN** (symbolic green ball) sign (R10-12) sign shall be used.

D. Variable Left-Turn Mode - If the protected only mode occurs during one or more periods of the day, and the permissive only mode or the combined protected/permissive mode occurs during other periods of the day, the requirements of Paragraphs A, B, and C above that are appropriate to that mode of operation shall be met subject to the following:

1. The **CIRCULAR GREEN** and **CIRCULAR YELLOW** signal indications shall not be displayed when operating in the protected only mode.
2. The left-turn **GREEN ARROW** and left-turn **YELLOW ARROW** signal indications shall not be displayed when operating in the permissive only mode.

Option:

Additional appropriate signal indications or changeable message signs may be used to meet the requirements for the variable left-turn mode.

Section 4D.07 Application of Steady Signal Indications For Right Turns

Support:

Right-turning traffic is controlled by one of four modes as follows:

- A. Permissive Only Mode - turns made on the CIRCULAR GREEN signal indication after yielding to pedestrians.
- B. Protected Only Mode - turns made only when the right-turn GREEN ARROW signal indication is displayed.
- C. Protected/Permissive Mode - both modes occur on an approach during the same cycle.
- D. Variable Right-Turn Mode - the operating mode changes among the protected only mode and/or the protected/permissive mode and/or the permissive only mode during different periods of the day.

Standard:

The required right-turn signal faces and operation for an approach shall be determined by the selected mode of right-turn operation, as follows:

- A. **Permissive Only Mode - A separate signal indication or signal face for right turns shall not be required. The signal indication for permissive only mode right turns shall be the same color as the signal indication for adjacent through traffic, except that if the right turn is held to provide an exclusive pedestrian movement, a separate right-turn RED ARROW signal indication shall be provided.**
- B. **Protected Only Mode - The right-turn signal face shall be capable of displaying one of the following sets of signal indications:**
 - 1. **Right-turn RED ARROW, YELLOW ARROW, and GREEN ARROW signal indications only. At least one right-turn signal face shall be provided in addition to the two approach signal faces required in Section 4D.15 for the through movement. Only one of the three colors shall be illuminated at any given time. A signal instruction sign shall not be required with this set of signal indications. If used, it shall be a RIGHT ON GREEN ARROW ONLY sign (R10-5a); or**
 - 2. **CIRCULAR RED, right-turn YELLOW ARROW, and right-turn GREEN ARROW signal indications. At least one right-turn signal face shall be provided in addition to the two approach signal faces required in Section 4D.15 for the through movement. Only one of three colors shall be illuminated at any given time. Unless the CIRCULAR RED signal indication is shielded, hooded, louvered, positioned, or designed such that it cannot be seen by drivers in the through lane(s), either a RIGHT TURN SIGNAL sign (R10-10) or a visibility-limited CIRCULAR RED signal indication shall be used.**

3. **CIRCULAR RED, CIRCULAR YELLOW, CIRCULAR GREEN, and right-turn GREEN ARROW signal indications. This four-section signal face shall be used only when the CIRCULAR GREEN and right-turn GREEN ARROW signal indications begin and terminate together. During each interval, the circular signal indication shall be the same color as the signal indication on the signal faces for the adjacent through traffic.**
- C. Protected/Permissive Mode - A separate signal face is not required for the right turn, but, if provided, it shall be considered an approach signal face, and shall meet the following requirements:**
1. **During the protected right-turn movement, the signal face shall simultaneously display:**
 - (a) **A right-turn GREEN ARROW signal indication, and**
 - (b) **A circular signal indication that is the same color as the signal indication for the adjacent through lane on the same approach as the protected right turn.**
 2. **During the permissive right-turn movement, all signal faces on the approach shall display a CIRCULAR GREEN signal indication.**
 3. **All signal faces on the approach shall simultaneously display the same color of circular signal indications to both through and right-turn road users.**
- D. Variable Right-Turn Mode - If the protected only mode occurs during one or more periods of the day, and the permissive only mode or the combined protected/permissive mode occurs during other periods of the day, the requirements of Paragraphs A, B, and C above that are appropriate to that mode of operation shall be met subject to the following:**
1. **The CIRCULAR GREEN and CIRCULAR YELLOW signal indications shall not be displayed when operating in the protected only mode.**
 2. **The right-turn GREEN ARROW and right-turn YELLOW ARROW signal indications shall not be displayed when operating in the permissive only mode.**

Option:

Additional appropriate signal indications or changeable message signs may be used to meet the requirements for the variable right-turn mode.

Section 4D.08 Prohibited Steady Signal Indications**Standard:**

The following combinations of signal indications shall not be simultaneously displayed on any one signal face:

- A. CIRCULAR GREEN with CIRCULAR YELLOW.
- B. CIRCULAR RED with CIRCULAR YELLOW.
- C. CIRCULAR GREEN with CIRCULAR RED.
- D. Straight-through GREEN ARROW with CIRCULAR RED.

The above combinations shall not be simultaneously displayed in different signal faces on any one approach unless one of the following conditions exists:

- A. One of the signal faces is a turn signal controlling a protected only mode turn, and a LEFT (RIGHT) TURN SIGNAL sign (R10-10) (see Sections 4D.06 and 4D.07) is mounted adjacent to each such signal face, or
- B. The signal faces are shielded, hooded, louvered, positioned, or designed so that the combination is not confusing to approaching road users.

A straight-through RED ARROW signal indication or a straight-through YELLOW ARROW signal indication shall not be displayed on any signal face, either alone or in combination with any other signal indication.

Section 4D.09 Unexpected Conflicts During Green or Yellow Intervals**Standard:**

A steady GREEN ARROW or YELLOW ARROW signal indication shall not be displayed to vehicular movements that are in conflict with the following:

- A. Other vehicles moving on a green or yellow signal indication. Vehicles departing in the same direction shall not be considered in conflict if, for each turn lane with moving traffic, there is a separate departing lane, and pavement markings or raised channelization clearly indicate which departure lane to use.

B. Pedestrians crossing in conformance with a WALKING PERSON (symbolizing WALK) or flashing UPRAISED HAND (symbolizing DONT WALK) signal indication.

Guidance:

No movement that creates an unexpected crossing of pathways of moving vehicles or pedestrians should be allowed during any green or yellow interval, except when all three of the following conditions are met:

- A. The movement involves only slight conflict, and
- B. Serious traffic delays are substantially reduced by permitting the conflicting movement, and
- C. Drivers and pedestrians subjected to the unexpected conflict are effectively warned thereof by a sign.

Section 4D.10 Yellow Change and Red Clearance Intervals

Standard:

A yellow signal indication shall be displayed following every CIRCULAR GREEN or GREEN ARROW signal indication.

The exclusive function of the yellow change interval shall be to warn traffic of an impending change in the right-of-way assignment.

The duration of a yellow change interval shall be predetermined.

Guidance:

A yellow change interval should have a duration of approximately 3 to 6 seconds. The longer intervals should be reserved for use on approaches with higher speeds.

Option:

The yellow change interval may be followed by a red clearance interval to provide additional time before conflicting traffic movements are released.

Standard:

The duration of a red clearance interval shall be predetermined.

Guidance:

A red clearance interval should have a duration not exceeding 6 seconds.

Section 4D.11 Application of Flashing Signal Indications

Standard:

The light source of a flashing signal indication shall be flashed continuously at a rate of not less than 50 nor more than 60 times per minute. The illuminated period of each flash shall be not less than half and not more than two-thirds of the total flash cycle.

Flashing signal indications shall comply with the requirements of other Sections of this Manual regarding shielding or positioning of conflicting signal indications, except that flashing yellow signal indications for through traffic shall not be required to be shielded or positioned to prevent visual conflict for road users in separately-controlled turn lanes.

The following applications shall apply whenever a traffic control signal is operated in the flashing mode:

- A. Each approach or protected only mode turn movement that is controlled during steady mode (stop-and-go) operation shall display a signal indication during flashing operation.**
- B. All signal faces that are flashed on an approach shall flash the same color, either yellow or red, except that separate signal faces for protected only mode turn movements and separate signal faces for protected/permissive left-turn movements shall be permitted to flash a CIRCULAR RED or RED ARROW signal indication when the through signal indications are flashed yellow. Shared signal faces for protected/permissive left-turn movements shall not be permitted to flash a CIRCULAR RED signal indication when the through signal indications are flashed yellow.**
- C. The appropriate RED ARROW or YELLOW ARROW signal indication shall be flashed when a signal face consists entirely of arrow lenses.**
- D. If a signal face includes both circular and arrow signal lenses of the color that is to be flashed, only the circular signal indication shall be flashed.**

Guidance:

When a traffic control signal is operated in the flashing mode, a flashing yellow signal indication should be used for the major street and a flashing red signal indication should be used for the other approaches unless flashing red signal indications are used on all approaches.

Section 4D.12 Flashing Operation of Traffic Control Signals**Standard:**

Each traffic control signal shall be provided with an independent flasher mechanism that operates in compliance with Section 4D.11. The flashing operation shall not be terminated by removal or turn off of the controller unit or of the conflict monitor (malfunction management unit) or both.

When a traffic control signal is operated in the flashing mode:

- A. Flashing yellow signal indications shall not be displayed for approaches with conflicting traffic movements, except for permissive left-turn movements.**
- B. At least one signal indication in each signal face on an approach shall be flashed except in the following circumstance:**

A single-section signal face consisting of a continuously-illuminated GREEN ARROW signal lens that is used alone to indicate a continuous movement in the steady (stop-and-go) mode shall remain continuously illuminated when the traffic control signal is operated in the flashing mode.

A manual switch, a conflict monitor (malfunction management unit) circuit, and, if appropriate, automatic means shall be provided to initiate the flashing mode.

The transition from steady (stop-and-go) mode to flashing mode, if initiated by a conflict monitor (malfunction management unit) or by a manual switch, shall be permitted to be made at any time.

Programmed changes from steady (stop-and-go) mode to flashing mode shall be made under either of the following circumstances:

- A. At the end of the common major-street red interval (such as just prior to the start of the green in both directions on the major street), or**

- B. Directly from a steady CIRCULAR GREEN or GREEN ARROW signal indication to a flashing CIRCULAR YELLOW or YELLOW ARROW signal indication, respectively.**

During programmed changes, no steady green signal indication or flashing yellow signal indication shall be terminated and immediately followed by a steady red or flashing red signal indication without first displaying the steady yellow signal indication.

Changes from flashing mode to steady (stop-and-go) mode shall be made under one of the following procedures:

- A. Yellow-red flashing mode: Changes from flashing mode to steady (stop-and-go) mode shall be made at the beginning of the major-street green interval (when a green signal indication is shown to through traffic in both directions on the major street), or if there is no common major-street green interval, at the beginning of the green interval for the major traffic movement on the major street.**
- B. Red-red flashing mode: Changes from flashing mode to steady (stop-and-go) mode shall be made by changing the flashing red indications to steady red indications followed by appropriate green indications to begin the steady mode cycle. These green indications shall be the beginning of the major-street green interval (when a green signal indication is shown to through traffic in both directions on the major street) or if there is no common major-street green interval, at the beginning of the green interval for the major traffic movement on the major street.**

Guidance:

When changing from the yellow-red flashing mode to steady (stop-and-go) mode, if there is no common major-street green interval, the provision of a steady red clearance interval for the other approaches before changing from a flashing yellow or a flashing red signal indication to a green signal indication on the major approach should be considered.

Any steady red clearance interval provided during the change from red-red flashing mode to steady (stop-and-go) mode should have a maximum duration of 6 seconds.

Support:

Section 4E.08 contains information regarding the operation of accessible pedestrian signal detector pushbutton locator tones during flashing operation.

Section 4D.13 Preemption and Priority Control of Traffic Control Signals

Support:

Traffic control signals may be designed and operated to respond to certain classes of approaching vehicles by altering the normal signal timing and phasing plan(s) during the approach and passage of those vehicles. The alternative plan(s) may be as simple as extending a currently displayed green interval or as complex as replacing the entire set of signal phases and timing.

Preemption control (see definition in Section 4A.02) is typically given to emergency vehicles and to vehicles such as boats and trains.

Examples of preemption control include the following:

- A. The prompt displaying of green signal indications at signalized locations ahead of fire vehicles, police cars, ambulances, and other official emergency vehicles.
- B. A special sequence of signal phases and timing to provide additional clearance time for vehicles to clear the tracks prior to the arrival of a train.
- C. A special sequence of signal phases to display a red indication to prohibit turning movements towards the tracks during the approach or passage of a train or transit vehicle.

Priority control (see definition in Section 4A.02) is typically given to certain non-emergency vehicles such as buses and light-rail vehicles.

Examples of priority control include the following:

- A. The displaying of early or extended green signal indications at an intersection to assist public transit vehicles in remaining on schedule.
- B. Special phasing to assist public transit vehicles in entering the travel stream ahead of the platoon of traffic.

Some types or classes of vehicles supersede others when a traffic control signal responds to more than one type or class. In general, a vehicle that is more difficult to control supersedes a vehicle that is easier to control. Typically, the order of priority is: boat, train, heavy vehicle (fire vehicle, emergency medical service), light vehicle (police), light rail, rubber-tired transit.

Standard:

During the transition into preemption control:

- A. The yellow change interval, and any red clearance interval that follows, shall not be shortened or omitted.**

- B. The shortening or omission of any pedestrian walk interval and/or pedestrian change interval shall be permitted.**
- C. The return to the previous steady green signal indication shall be permitted following a steady yellow signal indication in the same signal face, omitting the red clearance interval, if any.**

During preemption control and during the transition out of preemption control:

- A. The shortening or omission of any yellow change interval, and of any red clearance interval that follows, shall not be permitted.**
- B. A signal indication sequence from a steady yellow signal indication to a steady green signal indication shall not be permitted.**

During priority control and during the transition into or out of priority control:

- A. The shortening or omission of any yellow change interval, and of any red clearance interval that follows, shall not be permitted.**
- B. The shortening of any pedestrian walk interval below that time described in Section 4E.09 shall not be permitted.**
- C. The omission of a pedestrian walk interval and its associated change interval shall not be permitted unless the associated vehicular phase is also omitted or the pedestrian phase is exclusive.**
- D. The shortening or omission of any pedestrian change interval shall not be permitted.**
- E. A signal indication sequence from a steady yellow signal indication to a steady green signal indication shall not be permitted.**

Guidance:

When a traffic control signal that is returning to a steady mode from a dark mode (typically upon restoration from a power failure) receives a preemption or priority request, care should be exercised to ensure that vehicles or pedestrians are not misdirected into conflict with the vehicle making the request.

If a traffic control signal is installed near or within a highway-railroad grade crossing or if a highway-railroad grade crossing with active traffic control devices is within or near a signalized highway intersection, Chapter 8D should be consulted.

Traffic control signals operating under preemption control or under priority control

should be operated in a manner designed to keep traffic moving.

Traffic control signals that are designed to respond under preemption or priority control to more than one type or class of vehicle should be designed to respond in the relative order of importance or difficulty in stopping the type or class of vehicle.

Option:

During the change from a dark mode to a steady mode under a preemption or priority request, the display of signal indications that could misdirect road users may be prevented by the following:

- A. Having the traffic control signal remain in the dark mode.
- B. Having the traffic control signal remain in the flashing mode.
- C. Altering the flashing mode.
- D. Executing the normal start-up routine before responding.
- E. Responding directly to initial or dwell period.

A distinctive indication may be provided at the intersection to show that an emergency vehicle has been given control of the traffic signal (see Section 11-106 of the "Uniform Vehicle Code").

Preemption or priority control of traffic signals may also be a means of assigning priority right-of-way to specified classes of vehicles at certain non-intersection locations such as on approaches to one-lane bridges and tunnels, movable bridges, highway maintenance and construction activities, metered freeway entrance ramps, and transit operations.

Section 4D.14 Coordination of Traffic Control Signals

Guidance:

Traffic control signals within 800 m (0.5 mi) of one another along a major route or in a network of intersecting major routes should be coordinated, preferably with interconnected controller units. However, signal coordination need not be maintained across boundaries between signal systems that operate on different cycle lengths.

Support:

For coordination with railroad-highway grade crossing signals, see Sections 4D.13 and 8D.07.

Section 4D.15 Size, Number, and Location of Signal Faces by Approach**Support:**

Sections 4D.05, 4D.17, and 4D.18 contain additional information regarding the design of signal faces.

Standard:

There shall be two nominal diameter sizes for vehicular signal lenses: 200 mm (8 in) and 300 mm (12 in).

Three-hundred millimeter (12 in) signal lenses shall be used:

- A. For signal indications for approaches (see definition in Section 4A.02) where road users view both traffic control and lane-use control signal heads simultaneously.**
- B. If the nearest signal face is between 35 m (120 ft) and 45 m (150 ft) beyond the stop line, unless a supplemental near-side signal face is provided.**
- C. For signal faces located more than 45 m (150 ft) from the stop line.**
- D. For approaches to all signalized locations for which the minimum sight distance in Table 4D-1 cannot be met.**
- E. For arrow signal indications.**

A 200 mm (8 in) signal lens for a CIRCULAR RED signal indication shall not be used in combination with 300 mm (12 in) signal lens for a CIRCULAR GREEN signal indication or 300 mm (12 in) signal lens for a CIRCULAR YELLOW signal indication.

Option:

Different sizes of signal lenses may be used in the same signal face or signal head, except for the prohibitions listed in the Standards in this Section.

Guidance:

Three-hundred millimeter (12 in) signal lenses should be used for all signal indications for the following:

- A. Approaches with 85th-percentile approach speeds exceeding 60 km/h (40 mph).
- B. Approaches where a traffic control signal might be unexpected.

Table 4D-1. Minimum Sight Distance

85th- Percentile Speed (km/h)	Minimum Sight Distance (meters)	85th- Percentile Speed (mph)	Minimum Sight Distance (feet)
30	50	20	175
40	65	25	215
50	85	30	270
60	110	35	325
70	140	40	390
80	165	45	460
90	195	50	540
100	220	55	625
		60	715

C. All approaches without curbs and gutters where only post-mounted signal heads are used.

D. Locations where there is a significant percentage of elderly drivers.

Standard:

The signal faces for each approach to an intersection or a mid-block location shall be provided as follows:

- A. A minimum of two signal faces shall be provided for the major movement on the approach, even if the major movement is a turning movement.**
- B. See Section 4D.06 for left-turn signal faces.**
- C. See Section 4D.07 for right-turn signal faces.**
- D. Except where the width of an intersecting roadway or other conditions make it physically impractical:**

- 1. A signal face installed to satisfy the distance requirements as described in Paragraphs B and C in the first Standard of this Section, and at least one and preferably both of the signal faces required by Paragraph A in this Standard shall be located:**
 - (a) Not less than 12 m (40 ft) beyond the stop line.**
 - (b) Not more than 45 m (150 ft) beyond the stop line unless a supplemental near side signal face is provided.**
 - (c) As near as practical to the line of the driver's normal view, if mounted over the roadway.**
 - 2. A signal face installed to satisfy the distance requirements as described in Paragraphs B and C in the first Standard of this Section and at least one and preferably both of the signal faces required by Paragraph A in this Standard shall be located no higher than at a maximum height to the top of the signal housing mounted over a roadway of 7.8 m (25.6 ft) above the pavement (see Section 4D.17). For viewing distances between 12 m (40 ft) and 16 m (53 ft) from the stop line, the maximum mounting height to the top of the signal housing shall be as shown on Figure 4D-1. (See Section 4D.17 for additional information regarding mounting heights.)**
 - 3. At least one and preferably both of the signal faces required by Paragraph A above shall be located between two lines intersecting with the center of the approach at a point 3 m (10 ft) behind the stop line, one making an angle of approximately 20 degrees to the right of the center of the approach extended, and the other making an angle of approximately 20 degrees to the left of the center of the approach extended (see Figure 4D-2).**
 - 4. If both of the signal faces required by Paragraph A above are post-mounted, they shall both be on the far side of the intersection, one on the right and one on the left of the approach lane(s).**
- E. If the minimum sight distance in Table 4D-1 cannot be met, a sign shall be installed to warn approaching traffic of the traffic control signal.**
- F. Required signal faces for through traffic on any one approach shall be located not less than 2.4 m (8 ft) apart measured horizontally perpendicular to the approach between the centers of the signal faces.**
- G. If more than one turn signal face is provided for a protected-mode turn and if one or both of the signal faces are located over the roadway, the signal**

Figure 4D-1. Maximum Mounting Height of Signal Faces Located Between 12 Meters (40 Feet) and 16 Meters (53 Feet) from Stop Line

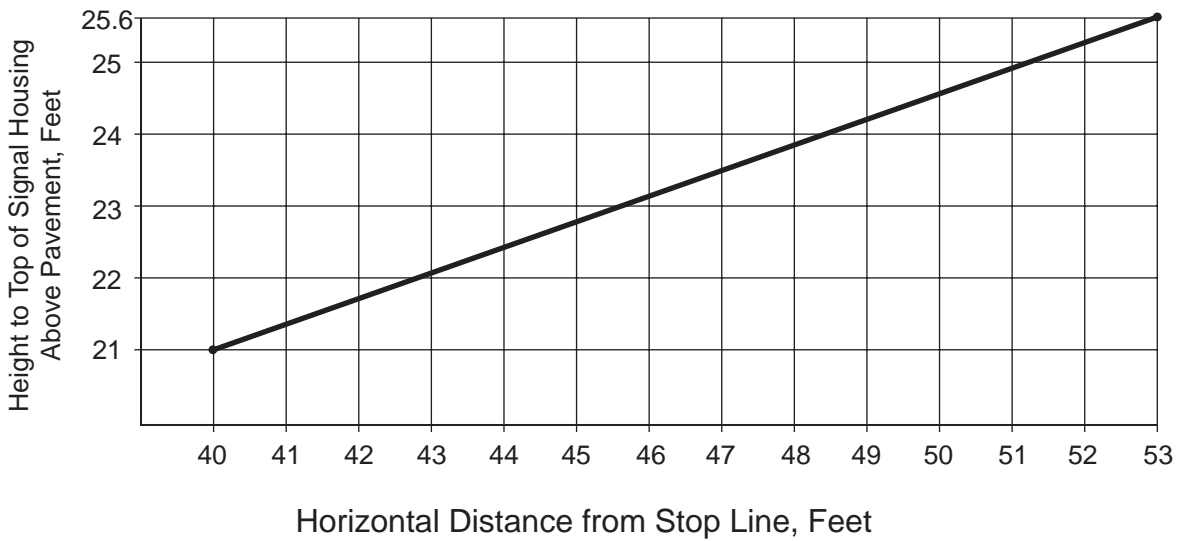
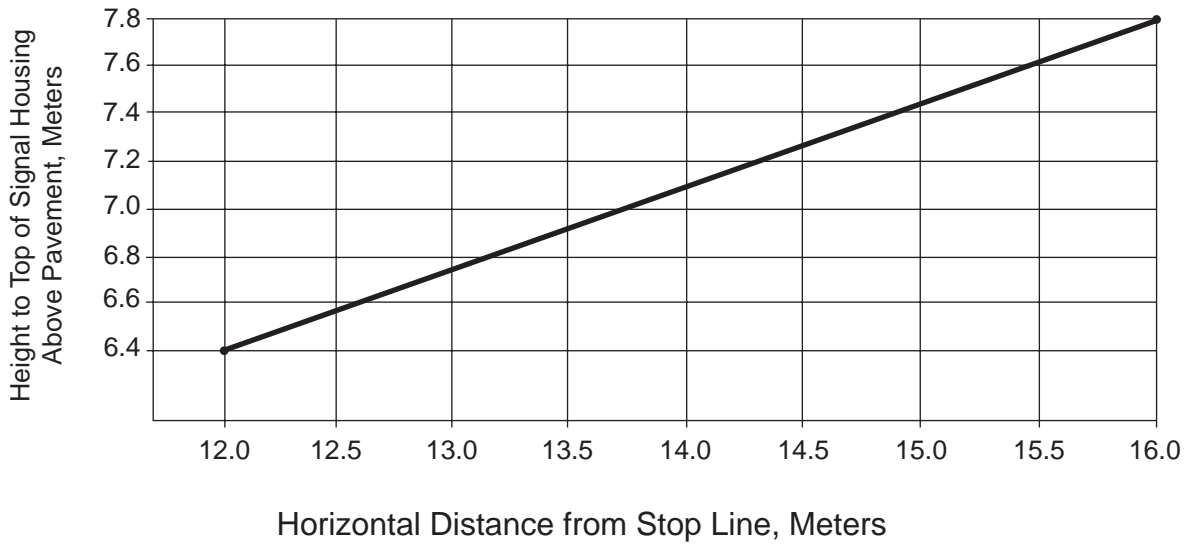
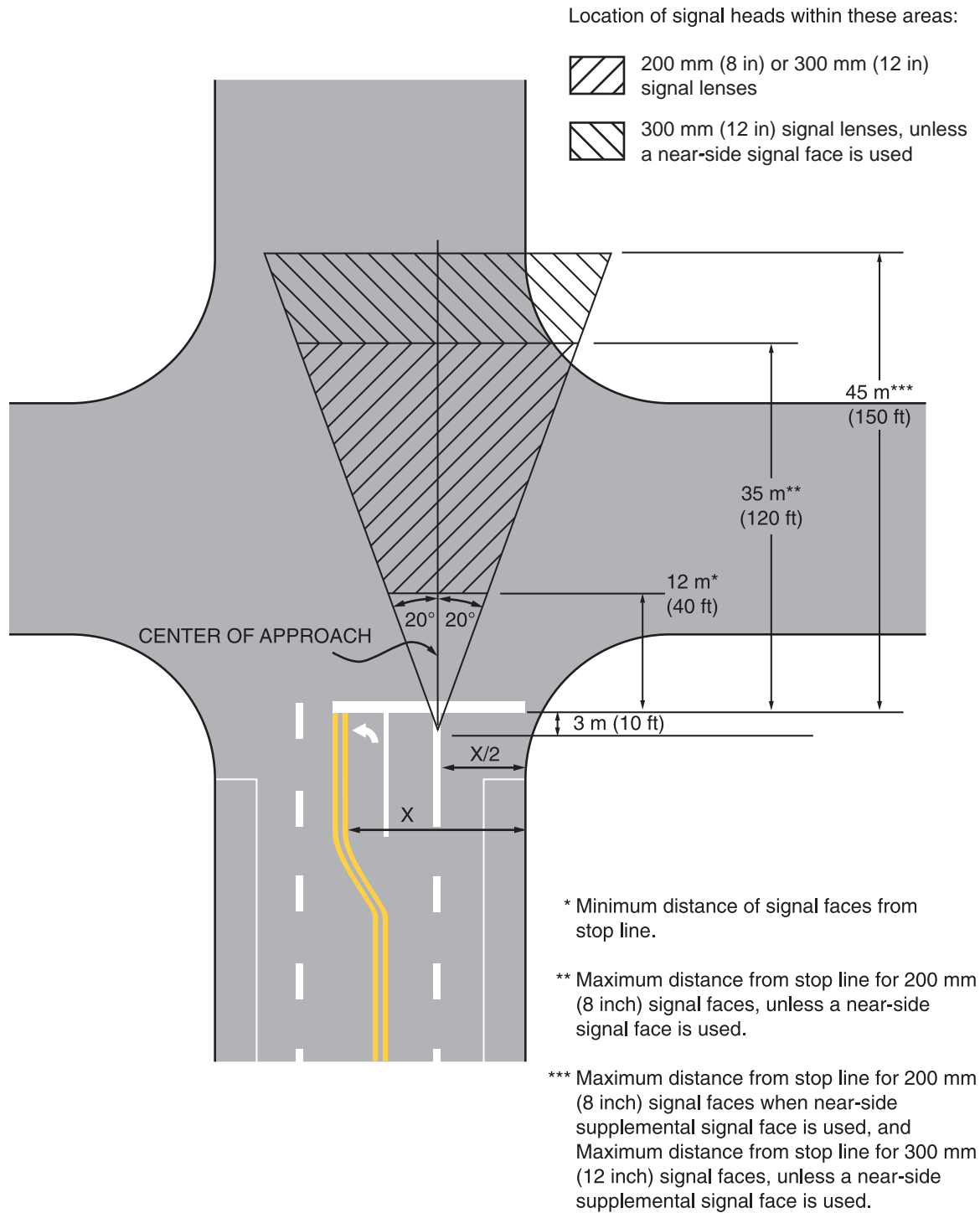

Figure 4D-2. Horizontal Location of Signal Faces



faces shall be located not less than 2.4 m (8 ft) apart measured horizontally perpendicular to the approach between the centers of the signal faces.

H. If supplemental signal faces are used, the following limitations shall apply:

- 1. Left-turn arrows shall not be used in near-right signal faces.**
- 2. Right-turn arrows shall not be used in far-left signal faces. A far-side median-mounted signal face shall be considered a far-left signal for this application.**

Guidance:

The two signal faces required for each approach should be continuously visible to traffic approaching the traffic control signal, from a point at least the minimum sight distance indicated in Table 4D-1 in advance of and measured to the stop line. This range of continuous visibility should be provided unless precluded by a physical obstruction or unless another signalized location is within this range.

If two or more left-turn lanes are provided for a separately-controlled protected only mode left-turn movement, or if a left-turn movement represents the major movement from an approach, two left-turn signal faces should be provided.

If two or more right-turn lanes are provided for a separately-controlled right-turn movement, or if a right-turn movement represents the major movement from an approach, two right-turn signal faces should be provided.

Near-side signal faces should be located as near as practical to the stop line.

If a signal face controls a specific lane or lanes of approach, its position should make it readily visible to road users making that movement.

Supplemental signal faces should be used if engineering judgment has shown that they are needed to achieve intersection visibility both in advance and immediately before the signalized location. If supplemental signal faces are used, they should be located to provide optimum visibility for the movement to be controlled.

At signalized mid-block crosswalks, at least one of the signal faces should be over the traveled way for each approach.

Option:

If a sign is installed to warn approaching road users of the traffic control signal, the sign may be supplemented by a Warning Beacon (see Section 4K.03).

A Warning Beacon used in this manner may be interconnected with the traffic signal controller assembly in such a manner as to flash yellow during the period when road users passing this beacon at the legal speed for the roadway might encounter a red signal indication (or a queue resulting from the display of the red signal indication) upon arrival at the signalized intersection.

Section 4D.16 Number and Arrangement of Signal Sections in Vehicular Traffic Control Signal Faces

Standard:

Each signal face at a signalized location shall have either three, four, or five signal sections.

A single-section signal face shall be permitted at a traffic control signal if it consists of a continuously-illuminated GREEN ARROW signal lens that is being used to indicate a continuous movement.

Arrows shall be pointed:

- A. Vertically upward to indicate a straight-through movement.**
- B. Horizontally in the direction of the turn to indicate a turn at approximately or greater than a right angle.**
- C. Upward with a slope at an angle approximately equal to that of the turn if the angle of the turn is substantially less than a right angle.**

The signal lenses in a signal face shall be arranged in a vertical or horizontal straight line, except that in a vertical array, signal lenses of the same color may be arranged horizontally adjacent to each other at right angles to the basic straight line arrangement. Such clusters shall be limited to two identical signal lenses or to two or three different signal lenses of the same color.

In each signal face, all red signal lenses in vertically-arranged signal faces shall be located above, and in horizontally-arranged signal faces shall be located to the left, of all yellow and green signal lenses.

If a CIRCULAR YELLOW signal lens is used, it shall be located between the red signal lens or lenses and all other signal lenses.

In vertically-arranged signal faces, each YELLOW ARROW signal lens shall be located immediately above the GREEN ARROW signal lens to which it applies. If a variable-indication signal section (capable of alternating between the display of a

GREEN ARROW and a YELLOW ARROW signal indication) is used, the lenses shall be in the same position relative to other lenses as are the GREEN ARROW signal lenses in a vertically-arranged signal face.

In horizontally-arranged signal faces, the YELLOW ARROW signal lens shall be located immediately to the left of the GREEN ARROW signal lens. If a variable-indication signal section (capable of alternating between the display of a GREEN ARROW and a YELLOW ARROW signal indication) is used, the variable left-turn arrow signal lens shall be located immediately to the right of the CIRCULAR YELLOW signal lens, the straight-through GREEN ARROW signal lens shall be located immediately to the right of the CIRCULAR GREEN signal lens, and the variable right-turn arrow signal lens shall be located to the right of all other signal lenses.

The relative positions of signal lenses within the signal face shall be as follows:

A. In a vertically-arranged signal face from top to bottom:

**CIRCULAR RED
Left-turn RED ARROW
Right-turn RED ARROW
CIRCULAR YELLOW
CIRCULAR GREEN
Straight-through GREEN ARROW
Left-turn YELLOW ARROW
Left-turn GREEN ARROW
Right-turn YELLOW ARROW
Right-turn GREEN ARROW**

B. In a horizontally-arranged signal face from left to right:

**CIRCULAR RED
Left-turn RED ARROW
Right-turn RED ARROW
CIRCULAR YELLOW
Left-turn YELLOW ARROW
Left-turn GREEN ARROW
CIRCULAR GREEN
Straight-through GREEN ARROW
Right-turn YELLOW ARROW
Right-turn GREEN ARROW**

C. If adjacent signal indications in a signal face are not identical, their arrangement shall follow Paragraph A or B above, as applicable.

Option:

In a vertically-arranged signal face, identical signal indications may be repeated in adjacent horizontal locations within the same signal face.

Horizontally-arranged and vertically-arranged signal faces may be used on the same approach provided they are separated to meet the lateral clearance required in Section 4D.15.

Support:

Figure 4D-3 illustrates some of the possible arrangements of signal lenses in signal faces.

Section 4D.17 Visibility, Shielding, and Positioning of Signal Faces**Standard:**

The primary consideration in signal face placement, aiming, and adjustment shall be to optimize the visibility of signal indications to approaching traffic. Road users approaching a signalized intersection or other signalized area, such as a mid-block crosswalk, shall be given a clear and unmistakable indication of their right-of-way assignment.

The geometry of each intersection to be signalized, including vertical grades, horizontal curves, and obstructions as well as the lateral and vertical angles of sight toward a signal face, as determined by typical driver-eye position, shall be considered in determining the vertical, longitudinal, and lateral position of the signal face.

In cases where irregular street design necessitates placing signal faces for different street approaches with a comparatively small angle between their respective signal lenses, each signal lens shall, to the extent practical, be shielded or directed by signal visors, signal louvers, or other means so that an approaching road user can see only the signal lens(es) controlling the movements on the road user's approach.

The bottom of the signal housing and any related attachments to a vehicular signal face located over a roadway shall be at least 4.6 m (15 ft) above the pavement. The top of the signal housing of a vehicular signal face located over a roadway shall not be more than 7.8 m (25.6 ft) above the pavement.

Signal visors exceeding 300 mm (12 in) in length shall not be used on free-swinging signal heads.

Figure 4D-3. Typical Arrangements of Signal Lenses in Signal Faces

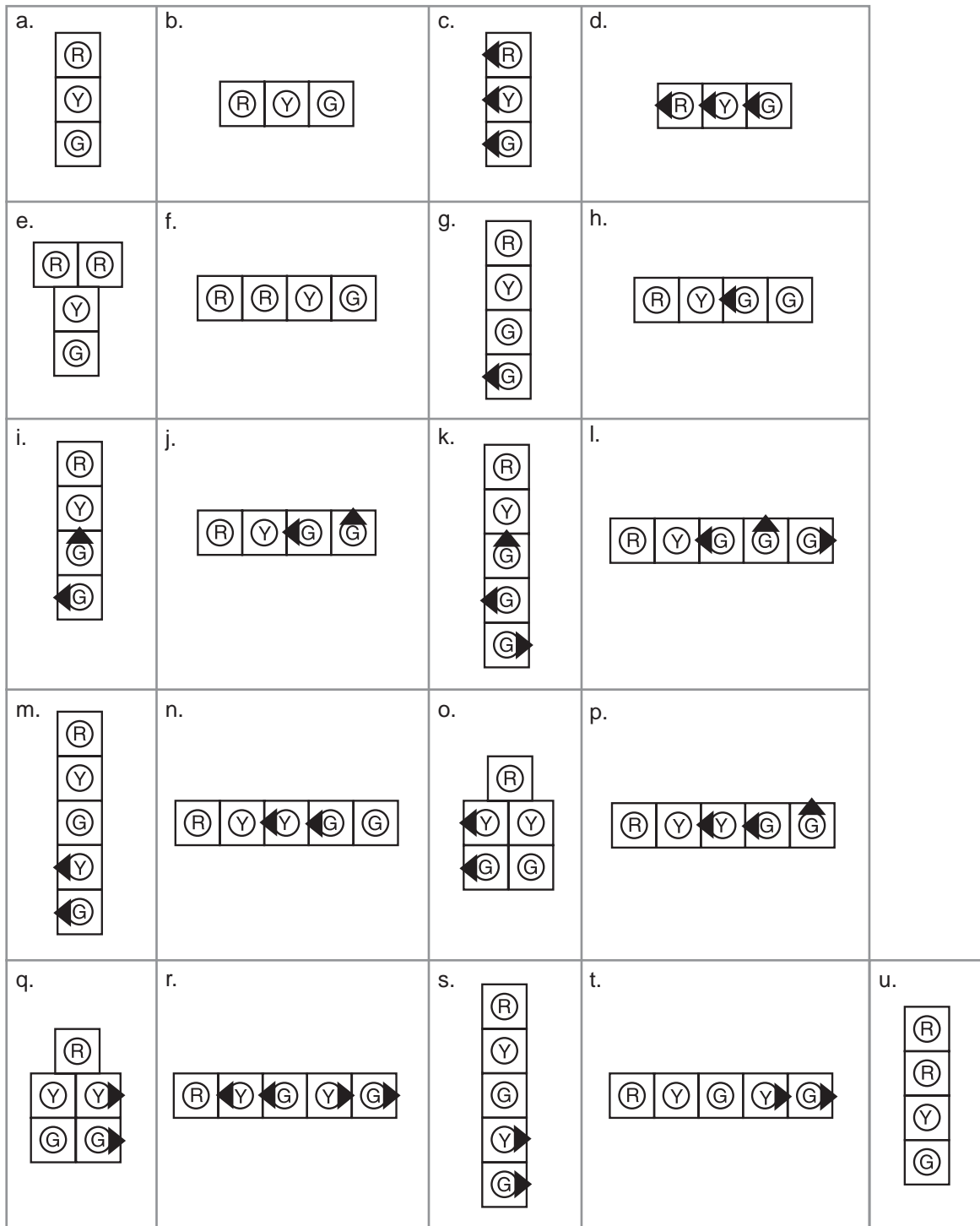

The bottom of the signal housing (including brackets) of a vehicular signal face that is vertically-arranged and not located over a roadway:

- A. Shall be at least 2.4 m (8 ft) but not more than 5.8 m (19 ft) above the sidewalk or, if there is no sidewalk, above the pavement grade at the center of the roadway.**
- B. Shall be at least 1.4 m (4.5 ft) but not more than 5.8 m (19 ft) above the median island grade of a center median island if located on the near side of the intersection.**

The bottom of the signal housing (including brackets) of a vehicular signal face that is horizontally-arranged and not located over a roadway:

- A. Shall be at least 2.4 m (8 ft) but not more than 6.7 m (22 ft) above the sidewalk or, if there is no sidewalk, above the pavement grade at the center of the roadway.**
- B. Shall be at least 1.4 m (4.5 ft) but not more than 6.7 m (22 ft) above the median island grade of a center median island if located on the near side of the intersection.**

Signal heads mounted at less than 4.6 meters (15 feet) from the bottom of the housing and any related attachments at the side of a roadway with curbs shall have a horizontal clearance of not less than 0.6 m (2 ft) from the face of a vertical curb. If there is no curb, signal heads shall have a horizontal clearance of not less than 0.6 m (2 ft) from the edge of a shoulder.

Guidance:

There should be legal authority to prohibit the display of any unauthorized sign, signal, marking, or device that interferes with the effectiveness of any official traffic control device (see Section 11-205 of the "Uniform Vehicle Code").

Signal visors should be used on signal faces to aid in directing the signal indication specifically to approaching traffic, as well as to reduce "sun phantom," which can result when external light enters the lens.

The use of signal visors, or the use of signal faces or devices that direct the light without a reduction in intensity, should be considered as an alternative to signal louvers because of the reduction in light output caused by signal louvers.

A signal backplate for target value enhancement should be used on signal faces viewed against a bright sky or bright or confusing backgrounds.

Support:

The use of backplates enhances the contrast between the traffic signals and their surroundings for both day and night conditions, which is also helpful to elderly drivers.

Option:

Special signal faces, such as visibility-limited signal faces, may be used such that the road user does not see signal indications intended for other approaches before seeing the signal indications for their own approach, if simultaneous viewing of both signal indications could cause the road user to be misdirected.

If the sight distance to the signal heads facing the approach is limited by horizontal or vertical alignment, supplemental signal faces aimed at a point on the approach at which the signal indications first become visible may be used.

Section 4D.18 Design, Illumination, and Color of Signal Sections**Standard:**

Each signal indication, except those used for pedestrian signal heads and lane-use control signals, shall be circular or arrow.

Letters or numbers shall not be displayed as part of a vehicular signal indication.

Each signal indication shall be independently illuminated.

Each circular signal indication shall emit a single color: red, yellow, or green.

Each arrow signal indication shall emit a single color: red, yellow, or green except that the alternate display (variable-indication signal section) of a GREEN ARROW and a YELLOW ARROW signal indication, both pointing in the same direction, shall be permitted, provided that they are not displayed simultaneously.

The arrow, which shall show only one direction, shall be the only illuminated part of an arrow signal indication.

Except for the requirements of this section, the requirements of the "Standards for Vehicle Traffic Control Signal Heads" (see Section 1A.11) shall be met.

References to signal lenses in this section shall not be used to limit signal optical units to incandescent lamps within optical assemblies that include lenses.

Support:

Research has resulted in signal optical units that are not lenses, such as, but not limited to, light-emitting diode (LED) traffic signal modules. Some units are practical for all signal indications, and some are practical for specific types such as visibility-limited signal indications.

Guidance:

The intensity and distribution of light from each illuminated signal lens should conform to the current "Standards for Vehicle Traffic Control Signal Heads" and "Traffic Signal Lamps" (see Section 1A.11).

If a signal indication is operated in the flashing mode for nighttime operation and the signal indication is so bright as to cause excessive glare, some form of automatic dimming should be used to reduce the brilliance of the signal indication.

Standard:

The inside of signal visors (hoods), the entire surface of louvers and fins, and the front surface of backplates shall have a dull black finish to minimize light reflection and to increase contrast between the signal indication and its background.

Guidance:

To obtain the best possible contrast with the visual background, signal housings should be highway yellow.

Section 4D.19 Lateral Placement of Signal Supports and Cabinets**Guidance:**

The following items should be considered when placing signal supports and cabinets:

- A. Reference should be made to the American Association of State Highway and Transportation Officials (AASHTO) "Roadside Design Guide" (see Section 1A.11) and to the Americans with Disabilities Act (ADA) (see the Department of Justice's ADA Standards for Accessible Design, 1991).
- B. Signal supports should be placed as far as practical from the edge of the traveled way without adversely affecting the visibility of the signal indications.

Where supports cannot be located based on the recommended AASHTO clearances, consideration should be given to the use of appropriate safety devices.

No part of a concrete base for a signal support should extend more than 100 mm (4 in) above the ground level at any point. This limitation does not apply to the concrete base for a rigid support.

- C. In order to minimize hindrance to the passage of persons with physical disabilities, a signal support or controller cabinet should not obstruct the sidewalk, or access from the sidewalk to the crosswalk.
- D. Controller cabinets should be located as far as is practical from the edge of the roadway.
- E. On medians, the above minimum clearances for signal supports should be obtained if practical.

Section 4D.20 Temporary Traffic Control Signals

Standard:

A temporary traffic control signal shall be defined as a traffic control signal that is installed for a limited time period. A portable traffic control signal shall be defined as a temporary traffic control signal that is designed so that it can be easily transported and reused at different locations.

Support:

A temporary traffic control signal is generally installed using methods that minimize the costs of installation, relocation, and/or removal. Typical temporary traffic control signals are for specific purposes, such as for one-lane, two-way facilities in temporary traffic control zones (see Chapter 4G), for a haul-road intersection, or for access to a site that will have a permanent access point developed at another location in the near future.

Standard:

Advance signing shall be used when employing a temporary traffic control signal.

A temporary traffic control signal shall:

- A. Meet the physical display and operational requirements of a conventional traffic control signal.**
- B. Be removed when no longer needed.**
- C. Be placed in the flashing mode when not being used if it will be operated in the steady mode within 5 working days; otherwise, it shall be removed.**

D. Be placed in the flashing mode during periods when it is not desirable to operate the signal, or the signal heads shall be covered, turned, or taken down to indicate that the signal is not in operation.

Guidance:

A temporary traffic control signal should be used only if engineering judgment indicates that installing the signal will improve the overall safety and/or operation of the location. The use of temporary traffic control signals by a work crew on a regular basis in their work area should be subject to the approval of the jurisdiction having authority over the roadway.

A temporary traffic control signal should not operate longer than 30 days unless associated with a longer-term temporary traffic control zone project.

For use of temporary traffic control signals in temporary traffic control zones, reference should be made to Section 6F.74.

Section 4D.21 Traffic Signal Signs, Auxiliary

Support:

Traffic signal signs are sometimes used at highway traffic signal locations to instruct or guide pedestrians, bicyclists, or drivers.

Standard:

The minimum clearance of the total assembly of traffic signal signs (see Section 2B.40) shall conform to the provisions of Section 4D.17.

If used, illuminated traffic signal signs shall be designed and mounted in such a manner as to avoid glare and reflections that seriously detract from the signal indications. Traffic control signal faces shall be given dominant position and brightness to ensure their priority in the overall display.

Guidance:

When an traffic signal sign at a highway traffic signal is applicable to a particular movement, the sign should be located adjacent to the signal face for that movement.

CHAPTER 4E. PEDESTRIAN CONTROL FEATURES

Section 4E.01 Pedestrian Signal Heads

Support:

Pedestrian signal heads provide special types of traffic signal indications exclusively intended for controlling pedestrian traffic. These signal indications consist of the illuminated symbols of a WALKING PERSON (symbolizing WALK) and an UPRAISED HAND (symbolizing DONT WALK).

Guidance:

Engineering judgment should determine the need for separate pedestrian signal heads (see Section 4D.03) and accessible pedestrian signals (see Section 4E.06).

Section 4E.02 Meaning of Pedestrian Signal Indications

Standard:

The pedestrian signal indications shall have the following meanings:

- A. A steady WALKING PERSON (symbolizing WALK) signal indication means that a pedestrian facing the signal indication may start to cross the roadway in the direction of the signal indication, possibly in conflict with turning vehicles.**
- B. A flashing UPRAISED HAND (symbolizing DONT WALK) signal indication means that a pedestrian shall not start to cross the roadway in the direction of the signal indication, but that any pedestrian who has already started to cross on a steady WALKING PERSON (symbolizing WALK) signal indication shall proceed out of the traveled way.**
- C. A steady UPRAISED HAND (symbolizing DONT WALK) signal indication means that a pedestrian shall not enter the roadway in the direction of the signal indication.**
- D. A flashing WALKING PERSON (symbolizing WALK) signal indication has no meaning and shall not be used.**

Section 4E.03 Application of Pedestrian Signal Heads**Standard:**

Pedestrian signal heads shall be used in conjunction with vehicular traffic control signals under any of the following conditions:

- A. If a traffic control signal is justified by a traffic engineering study and meets either Warrant 4, Pedestrian Volume or Warrant 5, School Crossing (see Chapter 4C).**
- B. If an exclusive signal phase is provided or made available for pedestrian movements in one or more directions, with all conflicting vehicular movements being stopped.**
- C. At an established school crossing at any signalized location.**
- D. When multi-phase signal indications (as with split-phase timing) would tend to confuse pedestrians guided only by vehicular signal indications.**

Guidance:

Pedestrian signal heads should be used under any of the following conditions:

- A. If it is necessary to assist pedestrians in making a safe crossing or if engineering judgment determines that pedestrian signal heads are justified to minimize vehicle-pedestrian conflicts.
- B. If pedestrians are permitted to cross a portion of a street, such as to or from a median of sufficient width for pedestrians to wait, during a particular interval but are not permitted to cross the remainder of the street during any part of the same interval.
- C. If no vehicular signal indications are visible to pedestrians, or if the vehicular signal indications that are visible to pedestrians starting or continuing a crossing provide insufficient guidance for them to decide when it is safe to cross, such as on one-way streets, at T-intersections, or at multi-phase signal operations.

Section 4E.04 Size, Design, and Illumination of Pedestrian Signal Indications**Standard:**

All new pedestrian signal indications shall be displayed within a rectangular background and shall consist of symbolized messages, except that existing

pedestrian signal indications with lettered messages may be retained for the remainder of their useful service life. The symbol designs that are set forth in the "Standard Highway Signs" book shall be used. Each signal indication shall be independently illuminated and emit a single color (see Figure 4E-1).

The UPRAISED HAND (symbolizing DONT WALK) signal section shall be mounted directly above or integral with the WALKING PERSON (symbolizing WALK) signal section.

The WALKING PERSON (symbolizing WALK) signal indication shall be white, conforming to the document entitled "Pedestrian Traffic Control Signal Indications" (see Section 1A.11), with all except the symbol obscured by an opaque material.

The UPRAISED HAND (symbolizing DONT WALK) signal indication shall be Portland orange, conforming to the document entitled "Pedestrian Traffic Control Signal Indications" (see Section 1A.11), with all except the symbol obscured by an opaque material.

When not illuminated, the WALKING PERSON (symbolizing WALK) and UPRAISED HAND (symbolizing DONT WALK) symbols shall not be readily visible to pedestrians at the far end of the crosswalk that the pedestrian signal indications control.

For pedestrian signal indications, the symbols shall be at least 150 mm (6 in) high.

Guidance:

Pedestrian signal indications should be conspicuous and recognizable to pedestrians at all distances from the beginning of the controlled crosswalk to a point 3 m (10 ft) from the end of the controlled crosswalk during both day and night.

For crosswalks where the pedestrian enters the crosswalk more than 30 m (100 ft) from the pedestrian signal indications, the symbols should be at least 225 mm (9 in) high.

Section 4E.05 Location and Height of Pedestrian Signal Heads

Standard:

Pedestrian signal heads shall be mounted with the bottom of the signal housing including brackets not less than 2.1 m (7 ft) nor more than 3 m (10 ft) above sidewalk level, and shall be positioned and adjusted to provide maximum visibility at the beginning of the controlled crosswalk.

Figure 4E-1. Typical Pedestrian Signal Indications



One Section (Outlined Symbol)



One Section (Solid Symbol)

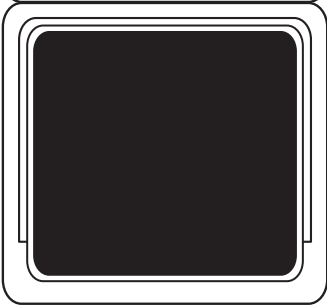
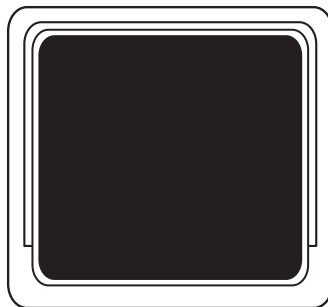

Two Section

If pedestrian signal heads are mounted on the same support as vehicular signal heads, there shall be a physical separation between them.

Section 4E.06 Accessible Pedestrian Signals

Support:

The primary technique that pedestrians who have visual disabilities use to cross streets at signalized intersections is to initiate their crossing when they hear the traffic in front of them stop and the traffic alongside them begin to move, corresponding to the onset of the green interval. This technique is effective at the vast majority of signalized intersections. The existing environment is often sufficient to provide the information that pedestrians who have visual disabilities need to operate safely at a signalized intersection. Therefore, the vast majority of signalized intersections will not require any accessible pedestrian signals.

Guidance:

If a particular signalized intersection presents difficulties for pedestrians who have visual disabilities to cross safely and effectively, the underlying safety and effectiveness concerns for all pedestrians should first be addressed before considering any access issues for pedestrians who have visual disabilities. Once a particular signalized intersection is reviewed for pedestrian safety in general, then an examination should ensue that considers whether accessible pedestrian signals are necessary to provide information that is not readily apparent in the existing environment.

Support:

The factors that might make crossing at an intersection difficult for pedestrians who have visual disabilities include: increasingly quiet cars, right turn on red (which masks the beginning of the through phase), continuous right-turn movements, complex signal operations, traffic circles, and wide streets. Further, low traffic volumes might make it difficult for pedestrians who have visual disabilities to discern signal phase changes.

Local organizations, providing support services to pedestrians who have visual and/or hearing disabilities, can often act as important advisors to the traffic engineer when consideration is being given to the installation of devices to assist such pedestrians. Additionally, orientation and mobility specialists or similar professionals also might be able to provide a wide range of advice.

Guidance:

Advice from organizations who represent pedestrians who have disabilities should be given deference because such organizations are the representative voice of the affected individuals. Agreement among such organizations should be widespread to determine that there is a community demand for the installation of accessible pedestrian signals.

An individual request, or a request from a small number of individuals, for the installation of accessible pedestrian signals should not automatically initiate implementation of the request. In assessing the request, traffic engineers and other officials should give deference to the input of the affected community as well as employ a standard cost/benefit analysis used to make decisions regarding the installation of traffic devices generally.

Support:

Accessible pedestrian signals provide information in non-visual format (such as audible tones, verbal messages, and/or vibrating surfaces).

Information regarding detectors for accessible pedestrian signals is found in Section 4E.08.

Standard:

When used, accessible pedestrian signals shall be used in combination with pedestrian signal timing. The information provided by an accessible pedestrian signal shall clearly indicate which pedestrian crossing is served by each device.

Under stop-and-go operation, accessible pedestrian signals shall not be limited in operation by the time of day or day of week.

Guidance:

The installation of accessible pedestrian signals at signalized intersections should be based on an engineering study, which should consider the following factors:

- A. Potential demand for accessible pedestrian signals.
- B. A request for accessible pedestrian signals.
- C. Traffic volumes during times when pedestrians might be present; including periods of low traffic volumes or high turn-on-red volumes.
- D. The complexity of traffic signal phasing.
- E. The complexity of intersection geometry.

Support:

Technology that provides different sounds for each non-concurrent signal phase has frequently been found to provide ambiguous information.

Standard:

When choosing audible tones, possible extraneous sources of sounds (such as wind, rain, vehicle back-up warnings, or birds) shall be considered in order to eliminate potential confusion to pedestrians who have visual disabilities.

Guidance:

Audible pedestrian tones should be carefully selected to avoid misleading pedestrians who have visual disabilities when the following conditions exist:

- A. Where there is an island that allows unsignalized right turns across a crosswalk between the island and the sidewalk.
- B. Where multi-leg approaches or complex signal phasing require more than two pedestrian phases, such that it might be unclear which crosswalk is served by each audible tone.
- C. At intersections where a diagonal pedestrian crossing is allowed, or where one street receives a WALKING PERSON (symbolizing WALK) signal indication simultaneously with another street.

Standard:

When accessible pedestrian signals have an audible tone(s), they shall have a tone for the walk interval. The audible tone(s) shall be audible from the beginning of the associated crosswalk. If the tone for the walk interval is similar to the pushbutton locator tone, the walk interval tone shall have a faster repetition rate than the associated pushbutton locator tone.

Support:

A pushbutton locator tone is a repeating sound that informs approaching pedestrians that they are required to push a button to actuate pedestrian timing, and that enables visually-impaired pedestrians to locate the pushbutton.

Guidance:

The accessible walk signal tone should be no louder than the locator tone, except when there is optional activation to provide a louder signal tone for a single pedestrian phase.

Automatic volume adjustment in response to ambient traffic sound level should be provided up to a maximum volume of 89 dB. Where automatic volume adjustment is used, tones should be no more than 5 dB louder than ambient sound.

Standard:

When verbal messages are used to communicate the pedestrian interval, they shall provide a clear message that the walk interval is in effect, as well as to which crossing it applies.

The verbal message that is provided at regular intervals throughout the timing of the walk interval shall be the term "walk sign," which may be followed by the name of the street to be crossed.

A verbal message is not required at times when the walk interval is not timing, but, if provided:

A. It shall be the term "wait."

B. It need not be repeated for the entire time that the walk interval is not timing.

Option:

Accessible pedestrian signals that provide verbal messages may provide similar messages in languages other than English, if needed, except for the terms "walk sign" and "wait."

Support:

A vibrotactile pedestrian device communicates information about pedestrian timing through a vibrating surface by touch.

Standard:

Vibrotactile pedestrian devices, where used, shall indicate that the walk interval is in effect, and for which direction it applies, through the use of a vibrating directional arrow or some other means.

Guidance:

When provided, vibrotactile pedestrian devices should be located next to, and on the same pole as, the pedestrian pushbutton, if any, and adjacent to the intended crosswalk.

Section 4E.07 Pedestrian Detectors

Guidance:

When pedestrian actuation is used, pedestrian pushbutton detectors should be easy to use and conveniently located near each end of the crosswalks.

Standard:

Signs (see Section 2B.40) shall be mounted adjacent to or integral with pedestrian pushbutton detectors, explaining their purpose and use.

Option:

At certain locations, a sign in a more visible location may be used to call attention to the pedestrian detector.

Guidance:

If two crosswalks, oriented in different directions, end at or near the same location, the positioning of pedestrian detectors and/or the legends on the pedestrian detector signs should clearly indicate which crosswalk signal is actuated by each pedestrian detector.

Standard:

If the pedestrian clearance time is sufficient only to cross from the curb or shoulder to a median of sufficient width for pedestrians to wait and the signals are pedestrian actuated, an additional pedestrian detector shall be provided in the median.

Guidance:

The use of additional pedestrian detectors on islands or medians where a pedestrian might become stranded should be considered.

A mounting height of approximately 1.1 m (3.5 ft) above the sidewalk should be used for pedestrian pushbutton detectors.

If used, special purpose pushbuttons (to be operated only by authorized persons) should include a housing capable of being locked to prevent access by the general public.

Standard:

If special purpose pushbuttons are used, instructional signs shall not be required.

If used, a pilot light or other means of indication installed with a pedestrian pushbutton shall not be illuminated until actuation. Once it is actuated, it shall remain illuminated until the pedestrian's green or WALKING PERSON (symbolizing WALK) signal indication is displayed.

Section 4E.08 Accessible Pedestrian Signal Detectors

Support:

An accessible pedestrian signal detector is a device designated to assist the pedestrian who has visual or physical disabilities in activating the pedestrian phase.

Option:

Accessible pedestrian signal detectors may be pushbuttons or passive detection devices.

Pushbutton locator tones may be used with accessible pedestrian signals.

Standard:

At accessible pedestrian signal locations with pedestrian actuation, each pushbutton shall activate both the walk interval and the accessible pedestrian signals.

Guidance:

At accessible pedestrian signal locations, pushbuttons should clearly indicate which crosswalk signal is actuated by each pushbutton. Pushbuttons and tactile arrows should have high visual contrast (see the Department of Justice's Americans with Disabilities Act Standards for Accessible Design, 1991). Tactile arrows should point in the same direction as the associated crosswalk. At corners of signalized locations with accessible pedestrian signals where two pedestrian pushbuttons are provided, the pushbuttons should be separated by a distance of at least 3 m (10 ft). This enables pedestrians who have visual disabilities to distinguish and locate the appropriate pushbutton.

Pushbuttons for accessible pedestrian signals should be located as follows:

- A. Adjacent to a level all-weather surface to provide access from a wheelchair, and where there is an all-weather surface, wheelchair accessible route to the ramp.
- B. Within 1.5 m (5 ft) of the crosswalk extended.
- C. Within 3 m (10 ft) of the edge of the curb, shoulder, or pavement.
- D. Parallel to the crosswalk to be used (see Figure 4E-2).

If the pedestrian clearance time is sufficient only to cross from the curb or shoulder to a median of sufficient width for pedestrians to wait and accessible pedestrian detectors are used, an additional accessible pedestrian detector should be provided in the median.

Figure 4E-2. Recommended Pushbutton Locations for Accessible Pedestrian Signals

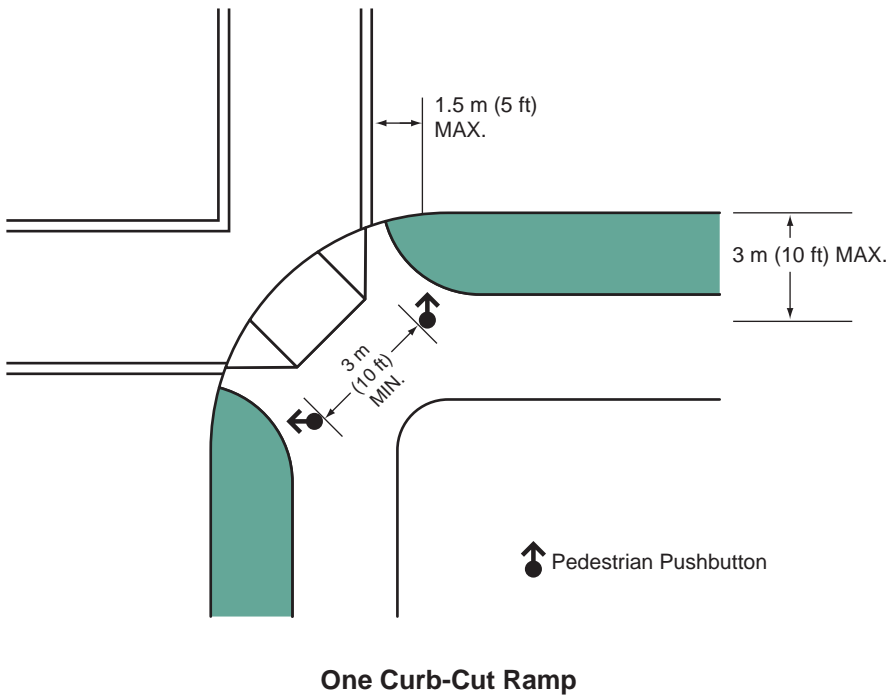
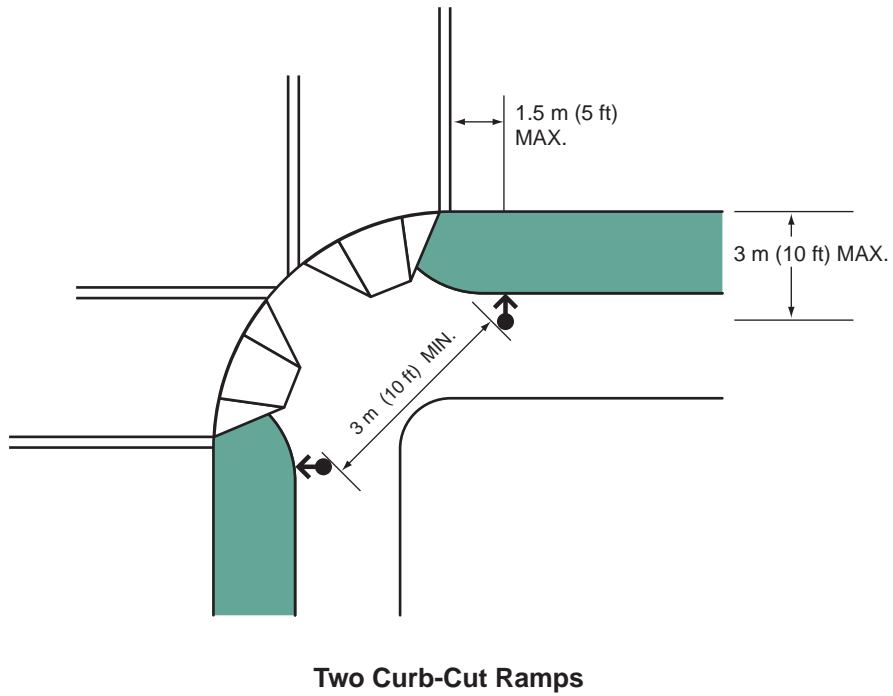

Standard:

When used, pushbutton locator tones shall be easily locatable, shall have a duration of 0.15 seconds or less, and shall repeat at 1-second intervals.

Guidance:

Pushbuttons should be audibly locatable. Pushbutton locator tones should be intensity responsive to ambient sound, and be audible 1.8 to 3.7 m (6 to 12 ft) from the pushbutton, or to the building line, whichever is less. Pushbutton locator tones should be no more than 5 dB louder than ambient sound.

Pushbutton locator tones should be deactivated during flashing operation of the traffic control signal.

Option:

At locations with pretimed traffic signals or non-actuated approaches, pedestrian pushbuttons may be used to activate the accessible pedestrian signals.

The audible tone(s) may be made louder (up to a maximum of 89 dB) by holding down the pushbutton for a minimum of 3 seconds. The louder audible tone(s) may also alternate back and forth across the crosswalk, thus providing optimal directional information.

The name of the street to be crossed may also be provided in accessible format, such as Braille or raised print.

Section 4E.09 Pedestrian Intervals and Signal Phases**Standard:**

When pedestrian signal heads are used, a WALKING PERSON (symbolizing WALK) signal indication shall be displayed only when pedestrians are permitted to leave the curb or shoulder.

A pedestrian clearance time shall begin immediately following the WALKING PERSON (symbolizing WALK) signal indication. The first portion of the pedestrian clearance time shall consist of a pedestrian change interval during which a flashing UPRAISED HAND (symbolizing DONT WALK) signal indication shall be displayed. The remaining portions shall consist of the yellow change interval and any red clearance interval (prior to a conflicting green being displayed), during which a flashing or steady UPRAISED HAND (symbolizing DONT WALK) signal indication shall be displayed.

At intersections equipped with pedestrian signal heads, the pedestrian signal indications shall be displayed except when the vehicular traffic control signal is being operated in the flashing mode. At those times, the pedestrian signal lenses shall not be illuminated.

Guidance:

Except as noted in the Option, the walk interval should be at least 7 seconds in length so that pedestrians will have adequate opportunity to leave the curb or shoulder before the pedestrian clearance time begins.

Option:

If it is desired to favor the length of an opposing signal phase and if pedestrian volumes and characteristics do not require a 7-second walk interval, walk intervals as short as 4 seconds may be used.

Support:

The walk interval itself need not equal or exceed the pedestrian clearance time calculated for the roadway width, because many pedestrians will complete their crossing during the pedestrian clearance time.

Guidance:

The pedestrian clearance time should be sufficient to allow a pedestrian crossing in the crosswalk who left the curb or shoulder during the WALKING PERSON (symbolizing WALK) signal indication to travel at a normal walking speed of 1.2 m (4 ft) per second, to at least the center of the farthest traveled lane or to a median of sufficient width for pedestrians to wait. Where pedestrians who walk slower than normal, or pedestrians who use wheelchairs, routinely use the crosswalk, a walking speed of less than 1.2 m (4 ft) per second should be considered in determining the pedestrian clearance time.

Option:

Passive pedestrian detection equipment, which can detect pedestrians who need more time to complete their crossing and can extend the length of the pedestrian clearance time for that particular cycle, may be used in order to avoid using a lower walking speed to determine the pedestrian clearance time.

Guidance:

Where the pedestrian clearance time is sufficient only for crossing from the curb or shoulder to a median of sufficient width for pedestrians to wait, additional measures should be considered, such as median-mounted pedestrian signals, or additional signing.

Option:

The pedestrian clearance time may be entirely contained within the vehicular green interval.

On a street with a median of sufficient width for pedestrians to wait, a pedestrian clearance time that allows the pedestrian to cross only from the curb or shoulder to the median may be provided.

During the transition into preemption, the walk interval and the pedestrian change interval may be shortened or omitted as described in Section 4D.13.

CHAPTER 4F. TRAFFIC CONTROL SIGNALS FOR EMERGENCY VEHICLE ACCESS

Section 4F.01 Applications of Emergency-Vehicle Traffic Control Signals

Support:

An emergency-vehicle traffic control signal is a special traffic control signal that assigns the right-of-way to an authorized emergency vehicle.

Option:

An emergency-vehicle traffic control signal may be installed at a location that does not meet other traffic signal warrants such as at an intersection or other location to permit direct access from a building housing the emergency vehicle.

Guidance:

If a traffic control signal is not justified under the signal warrants of Chapter 4C and if gaps in traffic are not adequate to permit safe entrance of emergency vehicles, or the stopping sight distance for vehicles approaching on the major street is insufficient to permit safe entrance of emergency vehicles, installing an emergency-vehicle traffic control signal should be considered. If a traffic control signal is justified under the signal warrants of Chapter 4C, and a decision is made to install a traffic control signal, it should be installed to the Standards required for that type of signal (see Chapter 4D).

The sight distance determination should be based on the location of the visibility obstruction for the critical approach lane for each street or drive and the posted or statutory speed limit or 85th-percentile speed on the major street, whichever is higher.

Section 4F.02 Design of Emergency-Vehicle Traffic Control Signals

Standard:

Except as specified in this Section, an emergency-vehicle traffic control signal shall meet the requirements of this Manual.

An Emergency Vehicle (W11-8) sign with an EMERGENCY SIGNAL AHEAD (W11-12P) supplemental plaque shall be placed in advance of all emergency-vehicle traffic control signals. If a warning beacon is installed to supplement the W11-8 sign, the design and location of the beacon shall conform to the Standards specified in Sections 4K.01 and 4K.03.

Guidance:

At least one signal face for each approach on the major street should be located over the roadway.

The following size signal lenses should be used for emergency-vehicle traffic control signals: 300 mm (12 in) diameter for red and steady yellow signal indications, and 200 mm (8 in) diameter for flashing yellow or steady green signal indications.

Standard:

An EMERGENCY SIGNAL (R10-13) sign shall be mounted adjacent to a signal face on each major street approach (see Section 2B.40). If an overhead signal face is provided, the EMERGENCY SIGNAL sign shall be mounted adjacent to the overhead signal face.

Option:

An approach that only serves emergency vehicles may be provided with only one signal face.

Besides using a 200 mm (8 in) diameter signal indication, other appropriate means to reduce the flashing yellow light output may be used.

Section 4F.03 Operation of Emergency-Vehicle Traffic Control Signals**Standard:**

Right-of-way for emergency vehicles at signalized locations operating in the steady (stop-and-go) mode shall be obtained as specified in Section 4D.13.

As a minimum, the signal indications, sequence, and manner of operation of an emergency-vehicle traffic control signal installed at a mid-block location shall be as follows:

- A. The signal indication, between emergency-vehicle actuations, shall be either steady green or flashing yellow. If the flashing yellow signal indication is used instead of the steady green signal indication, it shall be displayed in the normal position of the steady green signal indication, while the red and steady yellow signal indications shall be displayed in their normal positions.**
- B. When an emergency vehicle actuation occurs, a steady yellow change interval followed by a steady red interval shall be displayed to traffic on the major street.**

- C. A yellow change interval is not required following the green interval for the emergency-vehicle driveway.**

Emergency-vehicle traffic control signals located at intersections shall either be operated in the flashing mode between emergency-vehicle actuations (see Section 4D.12) or be semi- or fully-traffic-actuated, to accommodate normal vehicular and pedestrian traffic on the streets.

Warning beacons, if used with an emergency-vehicle traffic control signal, shall be flashed only:

- A. For an appropriate time in advance of and during the steady yellow change interval for the major street; and**

- B. During the steady red interval for the major street.**

Guidance:

The duration of the red interval for traffic on the major street should be determined by on-site test-run time studies, but should not exceed 1.5 times the time required for the emergency vehicle to clear the path of conflicting vehicles.

Option:

An emergency-vehicle traffic control signal sequence may be initiated manually from a local control point such as a fire station or police headquarters or from an emergency vehicle equipped for remote operation of the signal.

4G. TRAFFIC CONTROL SIGNALS FOR ONE-LANE, TWO-WAY FACILITIES

Section 4G.01 Application of Traffic Control Signals for One-Lane, Two-Way Facilities

Support:

A traffic control signal at a narrow bridge, tunnel, or roadway section is a special signal that assigns the right-of-way for vehicles passing over a bridge or through a tunnel or roadway section that is not of sufficient width for two opposing vehicles to pass safely.

Temporary traffic control signals (see Section 4D.20) are the most frequent application of one-lane, two-way facilities.

Guidance:

Sight distance across or through the one-lane, two-way facility should be considered as well as the approach speed and sight distance approaching the facility when determining whether traffic control signals should be installed.

Option:

At a narrow bridge, tunnel, or roadway section where a traffic control signal is not justified under the conditions of Chapter 4C, a traffic control signal may be used if gaps in opposing traffic do not permit the safe flow of traffic through the one-lane section of roadway.

Section 4G.02 Design of Traffic Control Signals for One-Lane, Two-Way Facilities

Guidance:

The provisions of Chapter 4D shall apply to traffic control signals for one-lane, two-way facilities, except that:

- A. Durations of red clearance intervals should be adequate to clear the one-lane section of conflicting vehicles.
- B. Adequate means, such as interconnection, should be provided to prevent conflicting signal indications, such as green and green, at opposite ends of the section.

Section 4G.03 Operation of Traffic Control Signals for One-Lane, Two-Way Facilities

Standard:

Traffic control signals at one-lane, two-way facilities shall operate in a manner consistent with traffic requirements.

When in the flashing mode, the signal indications shall flash red.

Guidance:

Adequate time should be provided to allow traffic to clear the narrow facility before opposing traffic is allowed to move. Engineering judgment should be used to determine the proper timing for the signal.

CHAPTER 4H. TRAFFIC CONTROL SIGNALS FOR FREEWAY ENTRANCE RAMPS

Section 4H.01 Application of Freeway Entrance Ramp Control Signals

Support:

Ramp control signals are traffic control signals that control the flow of traffic entering the freeway facility.

Freeway entrance ramp control signals are sometimes used if controlling traffic entering the freeway could reduce the total expected delay to traffic in the freeway corridor, including freeway ramps and local streets, and if at least one of the following conditions is present:

- A. Congestion recurs on the freeway because traffic demand is in excess of the capacity, or congestion recurs or a high frequency of crashes exist at the freeway entrance because of inadequate ramp merging area. A good indicator of recurring freeway congestion is freeway operating speeds less than 80 km/h (50 mph) occurring regularly for at least a half-hour period. Freeway operating speeds less than 50 km/h (30 mph) for a half-hour period or more would indicate severe congestion.
- B. Controlling traffic entering a freeway assists in meeting local transportation system management objectives identified for freeway traffic flow, such as the following:
 - 1. Maintenance of a specific freeway level of service.
 - 2. Priority treatments with higher levels of service for mass transit and carpools.
 - 3. Redistribution of freeway access demand to other on-ramps.
- C. Predictable, sporadic congestion occurs on isolated sections of freeway because of short-period peak traffic loads from special events or from severe peak loads of recreational traffic.

Guidance:

The installation of ramp control signals should be preceded by an engineering study of the physical and traffic conditions on the highway facilities likely to be affected. The study should include the ramps and ramp connections and the surface streets that would be affected by the ramp control, as well as the freeway section concerned. Types of traffic data that should be obtained include, but are not limited to, traffic volumes, traffic crashes, freeway operating speeds, and travel time and delay on the freeway, approaches, ramps, and alternate surface routes.

Capacities and demand/capacity relationships should be determined for each freeway section. The locations and causes of capacity restrictions and those sections where demand exceeds capacity should be identified. From these and other data, estimates

should be made of desirable metering rates, probable reductions in the delay of freeway traffic, likely increases in delay to ramp traffic, and the potential impact on surface streets. The study should include an evaluation of the ramp's storage capacities for vehicles delayed at the signal, the impact of queued traffic on the local street intersection, and the availability of suitable alternate surface routes having adequate capacity to accommodate any additional traffic volume.

Before installing ramp control signals, consideration should be given to their potential acceptance by the public and the requirements for enforcing ramp control, as well as alternate means of increasing the capacity, reducing the demand, or improving the characteristics of the freeway.

Section 4H.02 Design of Freeway Entrance Ramp Control Signals

Standard:

Ramp control signals shall meet all of the standard design specifications for traffic control signals, except as noted herein:

- A. The signal face for freeway entrance ramp control signals shall be either a two-lens signal face containing red and green signal lenses or a three-lens signal face containing red, yellow, and green signal lenses.**
- B. A minimum of two signal faces per ramp shall face entering traffic.**
- C. Ramp control signal faces need not be illuminated when not in use.**

Ramp control signals shall be located and designed to minimize their viewing by mainline freeway traffic.

Option:

The required signal faces, if located at the side of the ramp roadway, may be mounted such that the height above the pavement grade at the center of the ramp roadway to the bottom of the signal housing of the lowest signal face is between 1.4 m (4.5 ft) and 1.8 m (6 ft).

CHAPTER 4I. TRAFFIC CONTROL SIGNALS FOR MOVABLE BRIDGES

Section 4I.01 Application of Traffic Control for Movable Bridges

Support:

Traffic control signals for movable bridges are a special type of highway traffic signal installed at movable bridges notifies road users to stop because of a road closure rather than alternately giving the right-of-way to conflicting traffic movements. The signals are operated in coordination with the opening and closing of the movable bridge, and with the operation of movable bridge warning and resistance gates, or other devices and features used to warn, control, and stop traffic.

Movable bridge warning gates installed at movable bridges decrease the likelihood of vehicles and pedestrians passing the stop line and entering an area where potential hazards exist because of bridge operations.

A movable bridge resistance gate is sometimes used at movable bridges and located downstream of the movable bridge warning gate. A movable bridge resistance gate may provide a physical deterrent to road users when placed in the appropriate position. The movable bridge resistance gates are considered a design feature and not a traffic control device; requirements for them are contained in the "Standard Specifications for Movable Highway Bridges" (see Page i for AASHTO's address).

Standard:

Traffic control at movable bridges shall include both signals and gates, except:

- A. Neither is required if other traffic control devices or measures considered appropriate are used under either of the following conditions:**
 - 1. On low-volume roads (roads of less than 400 vehicles average daily traffic).**
 - 2. At manually-operated bridges if electric power is not available.**
- B. Only signals are required in urban areas if intersecting streets or driveways make gates ineffective.**
- C. Only movable bridge warning gates are required if a traffic control signal that is controlled as part of the bridge operations exists within 150 m (500 ft) of the movable bridge resistance gates and no intervening traffic entrances exist.**

Section 4I.02 Design and Location of Movable Bridge Signals and Gates**Standard:**

The signal heads and mountings of movable bridge signals shall follow the provisions of Chapter 4D except as noted in this Section.

Since movable bridge operations cover a variable range of time periods between openings, the signal faces shall be one of the following types:

- A. Three-section signal faces with red, yellow, and green signal lenses, generally to be used if movable bridge operation is quite frequent.
- B. Two one-section signal faces with red signal lenses in a vertical array separated by a STOP HERE ON RED sign (R10-6) (see Section 2B.40).

Regardless of which signal type is selected, two signal faces shall be provided for each approach to the movable span.

If physical conditions prevent a road user from having a continuous view of at least two signal indications for the distance specified in Table 4D-1 in Section 4D.15, an auxiliary device (either a supplemental signal face or the mandatory DRAWBRIDGE AHEAD warning sign to which has been added a warning beacon that is interconnected with the movable bridge controller unit) shall be provided in advance of movable bridge signals and gates.

A DRAWBRIDGE AHEAD warning sign shall be used in advance of movable bridge signals and gates to give warning to road users, except in urban conditions where such signing would not be practical.

Movable bridge warning gates, if used, shall extend at least across the full width of the approach lanes if movable bridge resistance gates are used. On divided highways in which the roadways are separated by a barrier median, movable bridge warning gates, if used, shall extend across all roadway lanes approaching the span openings. Except as indicated below, wherever practical, movable bridge warning gates shall be located 30 m (100 ft) or more from the movable bridge resistance gates or, if movable bridge resistance gates are not used, 30 m (100 ft) or more from the movable span.

Movable bridge warning gates shall be at least standard railroad size, striped with 400 mm (16 in) alternate diagonal, fully-reflectORIZED red and white stripes. Flashing red lights in accordance with the Standards for those on railroad gates (see Section 8D.04) shall be included on the gate arm and they shall only be operated if the gate is closed or in the process of being opened or closed. In the horizontal position, the top of the gate shall be approximately 1.25 m (4 ft) above the pavement.

If two sets of gates (both a warning and a resistance gate) are used on long bridges or causeways for a single direction, traffic signals need not accompany the resistance gate nearest the span opening, but there shall be flashing red lights on the movable bridge warning gate.

Guidance:

Signal faces with 300 mm (12 in) diameter signal lenses should be used for movable bridge signals.

Insofar as practical, the height and lateral placement of signal faces should conform to the requirements for other traffic control signals in accordance with Section 4D.15. They should be located not more than 15 m (50 ft) in advance of the movable bridge warning gate.

Movable bridge warning gates should be of lightweight construction. In its normal upright position, the gate arm should provide adequate lateral clearance. If the movable bridge is close to a highway-rail grade crossing and traffic might possibly be stopped on the crossing as a result of the bridge opening, a traffic control device should notify the road users to not stop on the railroad tracks.

If movable bridge resistance gates are not used on undivided highways, movable bridge warning gates, if used, should extend across the full width of the roadway.

On bridges or causeways that cross a long reach of water and that might be hit by large marine vessels, within the limits of practicality, traffic should not be halted on a section of the bridge or causeway that is subject to impact.

In cases where it is not practical to halt traffic on a span that is completely safe from impact, traffic should be halted at least one span from the opening. If traffic is halted by signals and gates more than 100 m (330 ft) from the movable bridge warning gates (or from the span opening if movable bridge warning gates are not used), a second set of gates should be installed approximately 30 m (100 ft) from the gate or span opening.

Option:

Movable bridge signals may be supplemented with audible warning devices to provide additional warning to drivers and pedestrians.

If prevailing approach speeds are 40 km/h (25 mph) or less, signal heads with 200 mm (8 in) diameter lenses may be used.

The movable bridge resistance gates may be delineated, if practical, in a manner similar to the movable bridge warning gate.

The DRAWBRIDGE AHEAD sign may be supplemented by a warning beacon (see Section 4K.03).

A single full-width gate or two half-width gates may be used.

Support:

Traffic signals need not accompany the gates nearest the span opening.

The locations of movable bridge signals and gates are determined by the location of the movable bridge resistance gate (if used) rather than by the location of the movable spans. The movable bridge resistance gates for high-speed highways are preferably located 15 m (50 ft) or more from the span opening except for bascule and lift bridges, where they are often attached to, or are a part of, the structure.

Section 4I.03 Operation of Movable Bridge Signals and Gates

Standard:

Traffic control devices at movable bridges shall be coordinated with the movable spans, so that the signals, gates, and movable spans are controlled by the bridge tender through an interlocked control.

If the three-section type of signal face is used, the green signal indication shall be illuminated at all times between bridge openings, except that if the bridge is not expected to open during continuous periods in excess of 5 hours, a flashing yellow signal indication may be used. The signal shall display a steady red signal indication when traffic is required to stop. The duration of the yellow change interval between the display of the steady green and steady red signal indications, or flashing yellow and steady red signal indications, shall be predetermined.

If the vertical array of red signal lenses is the type of signal face selected, the red signal lenses shall flash alternately only when traffic is required to stop.

Guidance:

The duration of the yellow change interval should have a range from 3 to 6 seconds.

Signals on adjacent streets and highways should be interconnected with the drawbridge control if indicated by engineering judgment.

CHAPTER 4J. LANE-USE CONTROL SIGNALS

Section 4J.01 Application of Lane-Use Control Signals

Support:

Lane-use control signals are special overhead signals that permit or prohibit the use of specific lanes of a street or highway or that indicate the impending prohibition of their use. Lane-use control signals are distinguished by placement of special signal faces over a certain lane or lanes of the roadway and by their distinctive shapes and symbols. Supplementary signs are sometimes used to explain their meaning and intent.

Lane-use control signals are most commonly used for reversible-lane control, but are also used in non-reversible freeway lane applications.

Guidance:

A traffic engineering study should be conducted to determine whether a reversible-lane operation can be controlled satisfactorily by static signs (see Section 2B.23) or whether lane-use control signals are necessary. Lane-use control signals should be used to control reversible-lane operations if any of the following conditions are present:

- A. More than one lane is reversed in direction.
- B. Two-way or one-way left turns are allowed during peak-period reversible operations, but those turns are from a different lane than used during off-peak periods.
- C. Other unusual or complex operations are included in the reversible-lane pattern.
- D. Demonstrated crash experience occurring with reversible-lane operation controlled by static signs that can be corrected by using lane-use control signals at the times of transition between peak and off-peak patterns.
- E. An engineering study indicates that safer and more efficient operation of a reversible-lane system would be provided by lane-use control signals.

Option:

Lane-use control signals also may be used for reversible-lane operations at toll booths. They may also be used if there is no intent or need to reverse lanes, including:

- A. On a freeway, if it is desired to keep traffic out of certain lanes at certain hours to facilitate the merging of traffic from a ramp or other freeway.
- B. On a freeway, near its terminus, to indicate a lane that ends.
- C. On a freeway or long bridge, to indicate that a lane may be temporarily blocked by a crash, breakdown, construction or maintenance activities, and so forth.

Section 4J.02 Meaning of Lane-Use Control Signal Indications

Standard:

The meanings of lane-use control signal indications are as follows:

- A. A steady **DOWNWARD GREEN ARROW** signal indication shall mean that a road user is permitted to drive in the lane over which the arrow signal indication is located.
- B. A steady **YELLOW X** signal indication shall mean that a road user is to prepare to vacate, in a safe manner, the lane over which the signal indication is located because a lane control change is being made to a steady **RED X** signal indication.
- C. A steady **WHITE TWO-WAY LEFT-TURN ARROW** signal indication (see Figure 4J-1) shall mean that a road user is permitted to use a lane over which the signal indication is located for a left turn, but not for through travel, with the understanding that common use of the lane by oncoming road users for left turns is also permitted.
- D. A steady **WHITE ONE WAY LEFT-TURN ARROW** signal indication (see Figure 4J-1) shall mean that a road user is permitted to use a lane over which the signal indication is located for a left turn (without opposing turns in the same lane), but not for through travel.
- E. A steady **RED X** signal indication shall mean that a road user is not permitted to use the lane over which the signal indication is located and that this signal indication shall modify accordingly the meaning of all other traffic controls present. The road user shall obey all other traffic controls and follow normal safe driving practices.

Pavement markings (see Section 3B.03) shall be used in conjunction with reversible-lane control signals.

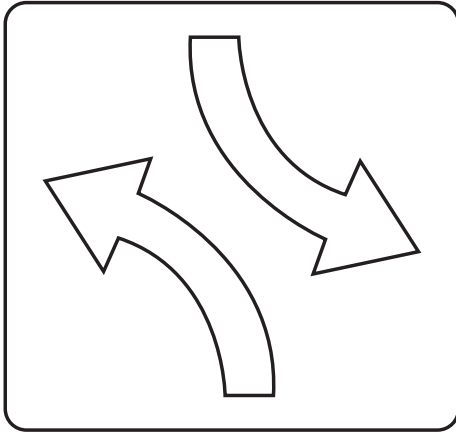
Figure 4J-1. Left-Turn Lane-Use Control Signals

Two-way left-turn arrow

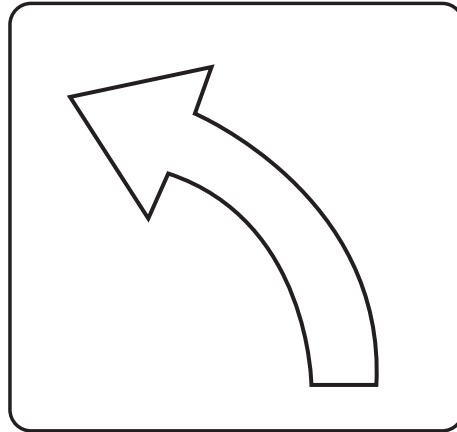

One-way left-turn arrow

White arrows on opaque background
 750 x 750 mm
 (30 x 30 in)

Section 4J.03 Design of Lane-Use Control Signals

Standard:

All lane-use control signal indications shall be in units with rectangular signal faces and shall have opaque backgrounds. Nominal minimum height and width of each DOWNWARD GREEN ARROW, YELLOW X, and RED X signal face shall be 450 mm (18 in) for typical applications. The WHITE TWO-WAY LEFT-TURN ARROW and WHITE ONE WAY LEFT-TURN ARROW signal faces shall have a nominal minimum height and width of 750 mm (30 in).

Each lane to be reversed or closed shall have signal faces with a DOWNWARD GREEN ARROW and a RED X symbol.

Each reversible lane that also operates as a two-way or one-way left-turn lane during certain periods shall have signal faces that also include the applicable WHITE TWO-WAY LEFT-TURN ARROW or WHITE ONE WAY LEFT-TURN ARROW symbol.

Each non-reversible lane immediately adjacent to a reversible lane shall have signal indications that display a DOWNWARD GREEN ARROW to traffic

traveling in the permitted direction and a RED X to traffic traveling in the opposite direction.

If in separate signal sections, the relative positions, from left to right, of the signal indications shall be RED X, YELLOW X, DOWNWARD GREEN ARROW, WHITE TWO-WAY LEFT-TURN ARROW, WHITE ONE WAY LEFT-TURN ARROW.

The color of lane-use control signal indications shall be clearly visible for 700 m (2,300 ft) at all times under normal atmospheric conditions, unless otherwise physically obstructed.

Lane-use control signal faces shall be located approximately over the center of the lane controlled.

If the area to be controlled is more than 700 m (2,300 ft) in length, or if the vertical or horizontal alignment is curved, intermediate lane-use control signal faces shall be located over each controlled lane at frequent intervals. This location shall be such that road users will at all times be able to see at least one signal indication and preferably two along the roadway, and will have a definite indication of the lanes specifically reserved for their use.

All lane-use control signal faces shall be located in a straight line across the roadway approximately at right angles to the roadway alignment.

The bottom of the signal housing of any lane-use control signal face shall be at least 4.6 m (15 ft) but not more than 5.8 m (19 ft) above the pavement grade.

On roadways having intersections controlled by traffic control signals, the lane-use control signal face shall be located sufficiently far in advance of or beyond such traffic control signals to prevent them from being misconstrued as traffic control signals.

Option:

In areas with minimal visual clutter and with speeds of 70 km/h (45 mph) or less, lane-use control signal faces with nominal height and width of 300 mm (12 in) may be used for the DOWNWARD GREEN ARROW, YELLOW X, and RED X signal faces.

Other sizes of lane-use control signal faces larger than 450 mm (18 in) with message recognition distances appropriate to signal spacing may be used for the DOWNWARD GREEN ARROW, YELLOW X, and RED X signal faces.

Signal faces with a YELLOW X symbol on an opaque background may be used as described in Section 4J.04.

Non-reversible lanes not immediately adjacent to a reversible lane on any street so controlled may also be provided with signal indications that display a DOWNWARD GREEN ARROW to traffic traveling in the permitted direction and a RED X to traffic traveling in the opposite direction.

The signal indications provided for each lane may be in separate signal sections or may be superimposed in the same signal section.

Section 4J.04 Operation of Lane-Use Control Signals

Standard:

All lane-use control signals shall be coordinated so that all the signal indications along the controlled section of roadway are operated uniformly and consistently. The lane-use control signal system shall be designed to reliably guard against showing any prohibited combination of signal indications to any traffic at any point in the controlled lanes.

For reversible-lane control signals, the following combination of signal indications shall not be shown simultaneously over the same lane to both directions of travel:

- A. DOWNWARD GREEN ARROW in both directions.**
- B. YELLOW X in both directions.**
- C. WHITE ONE WAY LEFT-TURN ARROW in both directions.**
- D. DOWNWARD GREEN ARROW in one direction and YELLOW X in the other direction.**
- E. WHITE TWO-WAY LEFT-TURN ARROW or WHITE ONE WAY LEFT-TURN ARROW in one direction and DOWNWARD GREEN ARROW in the other direction.**
- F. WHITE TWO-WAY LEFT-TURN ARROW in one direction and WHITE ONE WAY LEFT-TURN ARROW in the other direction.**
- G. WHITE ONE WAY LEFT-TURN ARROW in one direction and YELLOW X in the other direction.**

A moving condition in one direction shall be terminated either by the immediate display of a RED X signal indication or by a YELLOW X signal indication followed by a RED X signal indication. In either case, the duration of the RED X signal indication shall be sufficient to allow clearance of the lane before any moving condition is allowed in the opposing direction.

Whenever a DOWNWARD GREEN ARROW signal indication is changed to a WHITE TWO-WAY LEFT-TURN ARROW signal indication, the RED X signal indication shall continue to be displayed to the opposite direction of travel for an appropriate duration to allow traffic time to vacate the lane being converted to a two-way left-turn lane.

If an automatic control system is used, a manual control to override the automatic control shall be provided.

Guidance:

The type of control provided for reversible-lane operation should be such as to permit either automatic or manual operation of the lane-use control signals.

Standard:

If used, lane-use control signals shall be operated continuously, except that lane-use control signals that are used only for special events or other infrequent occurrences and lane-use control signals on non-reversible freeway lanes may be darkened when not in operation. The change from normal operation to non-operation shall occur only when the lane-use control signals display signal indications that are appropriate for the lane use that applies when the signals are not operated. The lane-use control signals shall display signal indications that are appropriate for the existing lane use when changed from non-operation to normal operations. Also, traffic control devices shall clearly indicate the proper lane use when the lane control signals are not in operation.

Support:

Section 2B.23 contains additional information concerning considerations involving left-turn prohibitions in conjunction with reversible-lane operations.

CHAPTER 4K. FLASHING BEACONS

Section 4K.01 General Design and Operation of Flashing Beacons

Support:

A Flashing Beacon is a highway traffic signal with one or more signal sections that operates in a flashing mode. It can provide traffic control when used as an intersection control beacon or warning in alternative uses.

Standard:

Flashing Beacon units and their mountings shall follow the provisions of Chapter 4D, except as specified herein.

Beacons shall be flashed at a rate of not less than 50 nor more than 60 times per minute. The illuminated period of each flash shall not be less than one-half and not more than two-thirds of the total cycle.

Guidance:

If used to supplement a warning or regulatory sign, the edge of the beacon signal housing should normally be located no closer than 300 mm (12 in) outside of the nearest edge of the sign.

Option:

An automatic dimming device may be used to reduce the brilliance of flashing yellow signal indications during night operation.

Section 4K.02 Intersection Control Beacon

Standard:

An Intersection Control Beacon shall consist of one or more signal faces directed toward each approach to an intersection. Each signal face shall consist of one or more signal sections of a standard traffic signal face, with flashing CIRCULAR YELLOW or CIRCULAR RED signal indications in each signal face. They shall be installed and used only at an intersection to control two or more directions of travel.

Application of Intersection Control Beacon signal indications shall be limited to the following:

A. Yellow on one route (normally the major street) and red for the remaining approaches.

B. Red for all approaches (if the warrant for a multi-way stop is satisfied).

Flashing yellow signal indications shall not face conflicting vehicular approaches.

A STOP sign shall be used on approaches to which a flashing red signal indication is shown on an Intersection Control Beacon (see Section 2B.04).

Guidance:

An Intersection Control Beacon should not be mounted on a pedestal in the roadway unless the pedestal is within the confines of a traffic or pedestrian island.

Option:

Supplemental signal indications may be used on one or more approaches in order to provide adequate visibility to approaching road users.

Intersection Control Beacons may be used at intersections where traffic or physical conditions do not justify conventional traffic control signals but crash rates indicate the possibility of a special need.

An Intersection Control Beacon is generally located over the center of an intersection; however, it may be used at other suitable locations.

Section 4K.03 Warning Beacon

Support:

Typical applications of Warning Beacons include the following:

- A. At obstructions in or immediately adjacent to the roadway.
- B. As supplement emphasis to regulatory or warning signs.
- C. As emphasis for mid-block crosswalks.
- D. On approaches to intersections where additional warning is required, or where special conditions exist.
- E. As supplements to regulatory signs, except STOP, YIELD, DO NOT ENTER, and SPEED LIMIT signs.

Standard:

A Warning Beacon shall consist of one or more signal sections of a standard traffic signal face with a flashing CIRCULAR YELLOW signal indication in each signal section.

A Warning Beacon shall be used only to supplement an appropriate warning or regulatory sign or marker. The beacon shall not be included within the border of the sign except for SCHOOL SPEED LIMIT sign beacons.

Warning Beacons, if used at intersections, shall not face conflicting vehicular approaches.

If a Warning Beacon is suspended over the roadway, the clearance above the pavement shall be at least 4.6 m (15 ft) but not more than 5.8 m (19 ft).

Guidance:

The condition or regulation justifying Warning Beacons should largely govern their location with respect to the roadway.

If an obstruction is in or adjacent to the roadway, illumination of the lower portion or the beginning of the obstruction or a sign on or in front of the obstruction, in addition to the beacon, should be considered.

Warning Beacons should be operated only during those hours when the condition or regulation exists.

Option:

If Warning Beacons have more than one signal section, they may be flashed either alternately or simultaneously.

A flashing yellow beacon interconnected with a traffic signal controller assembly may be used with a traffic signal warning sign (see Section 2C.26).

Section 4K.04 Speed Limit Sign Beacon**Standard:**

A Speed Limit Sign Beacon shall consist of one or more signal sections of a standard traffic control signal face, with a flashing CIRCULAR YELLOW signal indication in each signal section. The signal lenses shall have a nominal diameter of not less than 200 mm (8 in). If two lenses are used, they shall be vertically aligned, except that they may be horizontally aligned if the Speed Limit (R2-1) sign is longer horizontally than vertically. If two lenses are used, they shall be alternately flashed.

Option:

A Speed Limit Sign Beacon may be used with a fixed or variable Speed Limit sign. If applicable, a flashing Speed Limit Sign Beacon (with an appropriate accompanying sign) may be used to indicate that the speed limit shown is in effect.

Support:

Section 7B.11 contains additional Options for the use of Speed Limit Sign Beacons with SCHOOL SPEED LIMIT signs.

Section 4K.05 Stop Beacon**Standard:**

A Stop Beacon shall consist of one or more signal sections of a standard traffic signal face with a flashing CIRCULAR RED signal indication in each signal section. If two horizontally-aligned signal lenses are used, they shall be flashed simultaneously to avoid being confused with a highway-rail grade crossing flashing-light signals. If two vertically-aligned signal lenses are used, they shall be flashed alternately.

The bottom of the signal housing of a Stop Beacon shall be not less than 300 mm (12 in) nor more than 600 mm (24 in) above the top of a STOP sign (see Section 2B.04).

CHAPTER 4L. IN-ROADWAY LIGHTS

Section 4L.01 Application of In-Roadway Lights

Support:

In-Roadway Lights are special types of highway traffic signals installed in the roadway surface to warn road users that they are approaching a condition on or adjacent to the roadway that might not be readily apparent and might require the road users to slow down and/or come to a stop. This includes, but is not necessarily limited to, situations warning of marked school crosswalks, marked mid-block crosswalks, marked crosswalks on uncontrolled approaches, and other roadway situations involving pedestrian crossings.

Standard:

If used, In-Roadway Lights shall not exceed a height of 19 mm (0.75 in) above the roadway surface.

Option:

The flash rate for In-Roadway Lights may be different than the flash rate of standard beacons.

Section 4L.02 In-Roadway Warning Lights at Crosswalks

Standard:

If used, In-Roadway Warning Lights at crosswalks shall be installed only at marked crosswalks with applicable warning signs. They shall not be used at crosswalks controlled by YIELD signs, STOP signs, or traffic control signals.

If used, In-Roadway Warning Lights at crosswalks shall be installed along both sides of the crosswalk and shall span its entire length.

If used, In-Roadway Warning Lights at crosswalks shall initiate operation based on pedestrian actuation and shall cease operation at a predetermined time after the pedestrian actuation or, with passive detection, after the pedestrian clears the crosswalk.

If used, In-Roadway Warning Lights at crosswalks shall display a flashing yellow signal indication when actuated. The flash rate for In-Roadway Warning Lights at crosswalks shall be at least 50, but not more than 60, flash periods per minute. The flash rate shall not be between 5 and 30 flashes per second to avoid frequencies that might cause seizures.

If used on one-lane, one-way roadways, a minimum of two In-Roadway Warning Lights shall be installed on the approach side of the crosswalk. If used on two-lane roadways, a minimum of three In-Roadway Warning Lights shall be installed along both sides of the crosswalk. If used on roadways with more than two lanes, a minimum of one In-Roadway Warning Light per lane shall be installed along both sides of the crosswalk.

If used, In-Roadway Warning Lights shall be installed in the area between the outside edge of the crosswalk line and 3 m (10 ft) from the outside edge of the crosswalk. In-Roadway Warning Lights shall face away from the crosswalk if uni-directional, or shall face away from and across the crosswalk if bi-directional.

Guidance:

If used, the period of operation of the In-Roadway Warning Lights following each actuation should be sufficient to allow a pedestrian crossing in the crosswalk to leave the curb or shoulder and travel at a normal walking speed of 1.2 m (4 ft) per second to at least the far side of the traveled way or to a median of sufficient width for pedestrians to wait. Where pedestrians who walk slower than normal, or pedestrians who use wheelchairs, routinely use the crosswalk, a walking speed of less than 1.2 m (4 ft) per second should be considered in determining the period of operation. Where the period of operation is sufficient only for crossing from a curb or shoulder to a median of sufficient width for pedestrians to wait, additional measures should be considered, such as median-mounted pedestrian actuators.

If used, In-Roadway Warning Lights should be installed in the center of each travel lane, at the centerline of the roadway, at each edge of the roadway or parking lanes, or at other suitable locations away from the normal tire track paths.

The location of the In-Roadway Warning Lights within the lanes should be based on engineering judgment.

Option:

In-Roadway Warning Lights at crosswalks may use pedestrian detectors to determine the duration of the operation instead of ceasing operation after a predetermined time.

On one-way streets, In-Roadway Warning Lights may be omitted on the departure side of the crosswalk.

Based on engineering judgment, the In-Roadway Warning Lights on the departure side of the crosswalk on the left side of a median may be omitted.

Unidirectional In-Roadway Warning Lights installed at crosswalk locations may have an optional, additional yellow light indication in each unit that is visible to pedestrians in the crosswalk. These lights may flash with and at the same flash rate as the light module in which each is installed. The purpose of these optional additional lights is to indicate to pedestrians in the crosswalk that the In-Roadway Warning Lights are in fact flashing as they cross the street.

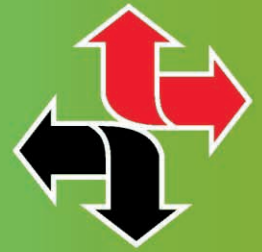

PART 5

Traffic Control Devices for Low-Volume Roads

MUTCD 2000

Manual on Uniform Traffic Control Devices

m i l l e n n i u m e d i t i o n

December 2000



U.S. Department
of Transportation

**Federal Highway
Administration**

PART 5. TRAFFIC CONTROL DEVICES FOR LOW-VOLUME ROADS**TABLE OF CONTENTS**

	<u>Page</u>
CHAPTER 5A. GENERALDec., 2000
Section 5A.01 Function.....	5A-1
Section 5A.02 Application	5A-2
Section 5A.03 Design.....	5A-2
Section 5A.04 Placement	5A-4
CHAPTER 5B. REGULATORY SIGNSDec., 2000
Section 5B.01 Introduction.....	5B-1
Section 5B.02 STOP and YIELD Signs (R1-1 and R1-2)	5B-1
Section 5B.03 Speed Limit Signs (R2 Series)	5B-1
Section 5B.04 Traffic Movement and Prohibition Signs (R3, R4, R5, R6, R9, R10, R11, R12, R13, and R14 Series)	5B-3
Section 5B.05 Parking Signs (R8 Series).....	5B-3
Section 5B.06 Other Regulatory Signs	5B-3
CHAPTER 5C. WARNING SIGNSDec., 2000
Section 5C.01 Introduction.....	5C-1
Section 5C.02 Horizontal Alignment Signs (W1-1 through W1-8).....	5C-1
Section 5C.03 Intersection Warning Signs (W2-1 through W2-5)	5C-1
Section 5C.04 Stop Ahead and Yield Ahead Signs (W3-1a, W3-2a)	5C-1
Section 5C.05 Narrow Bridge Sign (W5-2a).....	5C-4
Section 5C.06 ONE LANE BRIDGE Sign (W5-3)	5C-4
Section 5C.07 Hill Sign (W7-1a).....	5C-4
Section 5C.08 PAVEMENT ENDS Sign (W8-3).....	5C-5
Section 5C.09 Motorized Traffic and Crossing Signs (W11 Series and W8-6)	5C-5
Section 5C.10 Advisory Speed Plaque (W13-1).....	5C-5
Section 5C.11 DEAD END and NO OUTLET Plaques and Signs (W14-1P, W14-2P, W14-1, and W14-2).....	5C-6
Section 5C.12 NO TRAFFIC SIGNS Sign (W16-2)	5C-6
Section 5C.13 Other Warning Signs.....	5C-6
CHAPTER 5D. GUIDE SIGNSDec., 2000
Section 5D.01 Introduction	5D-1
CHAPTER 5E. MARKINGSDec., 2000
Section 5E.01 Introduction.....	5E-1
Section 5E.02 Centerline Markings	5E-1

Section 5E.03	Edge Line Markings	5E-1
Section 5E.04	Delineators	5E-2
Section 5E.05	Object Markers	5E-2
Section 5E.06	Other Markings	5E-2

CHAPTER 5F. TRAFFIC CONTROL FOR HIGHWAY-RAIL GRADE CROSSINGSDec., 2000

Section 5F.01	Introduction	5F-1
Section 5F.02	Highway-Rail Grade Crossing (Crossbuck) Sign (R15-1, R15-2)	5F-1
Section 5F.03	Highway-Rail Grade Crossing Advance Warning Signs (W10 Series).....	5F-1
Section 5F.04	STOP and YIELD Signs	5F-3
Section 5F.05	Pavement Markings.....	5F-3
Section 5F.06	Other Traffic Control Devices	5F-3

CHAPTER 5G. TEMPORARY TRAFFIC CONTROL ZONESDec., 2000

Section 5G.01	Introduction	5G-1
Section 5G.02	Applications.....	5G-3
Section 5G.03	Channelization Devices.....	5G-3
Section 5G.04	Markings.....	5G-3
Section 5G.05	Other Traffic Control Devices.....	5G-4

TABLES

CHAPTER 5A. GENERAL

Table 5A-1	Minimum Sign Sizes on Low-Volume Roads.....	5A-3
------------	---	------

CHAPTER 5A. GENERAL

Section 5A.01 Function

Support:

At some locations on low-volume roads, the use of traffic control devices might be needed to provide the road user limited, but essential, information regarding regulation, guidance, and warning.

Other Parts of this Manual contain criteria applicable to all low-volume roads, however, Part 5 specifically supplements and references the criteria for traffic control devices commonly used on low-volume roads.

Standard:

A low-volume road shall be defined for this Part of the Manual as follows:

- A. A low-volume road shall be a facility lying outside of built-up areas of cities, towns, and communities, and it shall have a traffic volume of less than 400 AADT.**
- B. A low-volume road shall not be a freeway, expressway, interchange ramp, freeway service road, or a road on a designated State highway system. In terms of highway classification, it shall be a variation of a conventional road or a special purpose road as defined in Section 2A.01.**
- C. A low-volume road shall be classified as either paved or unpaved.**

Support:

Low-volume roads typically include farm-to-market, recreational, resource management and development, and local roads.

Guidance:

The needs of unfamiliar road users for occasional, recreational, and commercial transportation purposes should be considered.

Section 5A.02 Application

Support:

It is possible, in many cases, to provide essential information to road users on low-volume roads with a limited number of traffic control devices. The focus might be on devices that:

- A. Warn of conditions not normally encountered,
- B. Prohibit unsafe movements, or
- C. Provide minimal destination guidance.

As with other roads, the application of traffic control devices on low-volume roads is based on engineering judgment or studies.

Standard:

The criteria contained in Part 5 shall not prohibit the installation nor the full application of traffic control devices on a low-volume road where conditions justify their use.

Guidance:

Additional traffic control devices and criteria contained in other Parts of the Manual should be considered for use on low-volume roads.

Section 5A.03 Design

Standard:

Traffic control devices for use on low-volume roads shall be designed in accordance with the criteria contained in Part 5, and where required, in other applicable Parts of the Manual.

The minimum sizes for signs installed on low-volume roads shall be as shown in Table 5A-1.

All signs shall be retroreflective or illuminated to show the same shape and similar color both day and night, unless specifically stated otherwise in other applicable Parts of this Manual. The requirements for sign illumination shall not be considered to be satisfied by street, highway, or strobe lighting.

Table 5A-1. Minimum Sign Sizes on Low-Volume Roads

Sign	MUTCD Code	Section	Sign Size	
			Millimeters	Inches
Stop	R1-1	5B.02	750 x 750	30 x 30
Yield	R1-2	5B.02	750 x 750 x 750	30 x 30 x 30
Speed Limit	R2-1	5B.03	450 x 600	18 x 24
Do Not Pass	R4-1	5B.04	600 x 750	24 x 30
Do Not Enter	R5-1	5B.04	750 x 750	30 x 30
No Trucks	R5-2	5B.04	600 x 600	24 x 24
One Way	R6-2	5B.04	450 x 600	18 x 24
No Parking	R8-3	5B.05	450 x 600	18 x 24
No Parking (Symbol)	R8-3a	5B.05	600 x 600	24 x 24
No Parking Supplemental Plaque	-----	5B.05	600 x 450	24 x 18
Road Closed	R11-2	5B.04	1200 x 750	48 x 30
Local Traffic Only	R11-3	5B.04	1500 x 750	60 x 30
Bridge Out	R11-3b	5B.04	1500 x 750	60 x 30
Weight Limit	R12-1	5B.04	600 x 750	24 x 30
Highway-Rail Crossing (Crossbuck) Sign	R15-1	5F.02	1200 x 225	48 x 9
Turn/Curve, Reverse Turn/Curve Winding Road	W1-1,2,3,4,5	5C.02	600 x 600	24 x 24
Large Arrow	W1-6	5C.02	900 x 450	36 x 18
Chevron	W1-8	5C.02	300 x 450	12 x 18
Intersection Warning Signs	W2-1,4,5	5C.03	600 x 600	24 x 24
Stop Ahead	W3-1a	5C.04	750 x 750	30 x 30
Yield Ahead	W3-2a	5C.04	750 x 750	30 x 30
Narrow Bridge	W5-2, 2a	5C.05	750 x 750	30 x 30
One Lane Bridge	W5-3	5C.06	750 x 750	30 x 30
Hill	W7-1, 1a	5C.07	600 x 600	24 x 24
XX % Grade	W7-3	5C.07	600 x 450	24 x 18
Next XX KM (Miles)	W7-3a	5C.09	600 x 450	24 x 18
Pavement Ends	W8-3	5C.08	750 x 750	30 x 30
No Center Stripe	W8-12	5G.02	600 x 600	24 x 24
Railroad Advance Warning	W10-1	5F.03	750 Dia	30 Dia
Crossing Warning	W10-2,3,4	5F.03	750 x 750	30 x 30
Entering / Crossing	W11 series	5C.09	600 x 600	24 x 24
Advisory Speed Plaque	W13-1	5C.10	450 x 450	18 x 18
Dead End / No Outlet Plaques	W14-1p, W14-2p	5C.11	600 x 600	24 x 24
No Passing Zone (pennant)	W14-3	5G.02	750 x 1000 x 1000	30 x 40 x 40
Supplemental Plaque	W16-1	5G.02	600 x 450	24 x 18
No Traffic Signs	W16-2	5C.12	750 x 750	30 x 30
Roadwork XX M (FT)	W20-1	5G.02	900 x 900	36 x 36
Flagger	W20-7a	5G.02	900 x 900	36 x 36
Be Prepared to Stop	W20-7b	5G.02	900 x 900	36 x 36
Workers	W21-1a	5G.02	900 x 900	36 x 36
Fresh Oil	W21-2	5G.02	600 x 600	24 x 24
Road Machinery Ahead	W21-3	5G.02	600 x 600	24 x 24
Shoulder Work	W21-5	5G.02	600 x 600	24 x 24
Survey Crew	W21-6	5G.02	750 x 750	30 x 30

All markings shall be visible at night and shall be retroreflective unless ambient illumination ensures that the markings are adequately visible.

Guidance:

Larger sign sizes should be used where engineering judgment indicates a need based on high vehicle operating speeds, driver expectancy, traffic operations, or roadway conditions.

Section 5A.04 Placement

Standard:

The traffic control devices used on low-volume roads shall be placed and positioned in accordance with the criteria contained in Part 5, and, where necessary, in accordance with the lateral, longitudinal, and vertical placement criteria contained in Part 2 and other applicable Sections of this Manual.

Guidance:

The placement of warning signs should conform to the guidance contained in Section 2C.05 and other applicable Sections of this Manual.

Option:

A lateral offset of not less than 0.6 m (2 ft) from the roadway edge to the roadside edge of a sign may be used where roadside features such as terrain, shrubbery, and/or trees prevent lateral placement in accordance with Section 2A.19.

Standard:

If located within a clear zone, roadside mounted sign supports shall be yielding, breakaway, or shielded with a longitudinal barrier or crash cushion as required in Section 2A.19.

CHAPTER 5B. REGULATORY SIGNS

Section 5B.01 Introduction

Support:

The purpose of a regulatory sign is to inform highway users of traffic laws or regulations, and to indicate the applicability of legal requirements that would not otherwise be apparent.

The criteria for regulatory signs are contained in Chapter 2B and in other Sections of this Manual. Criteria for regulatory signs that are specific to low-volume roads are contained in this Chapter.

Section 5B.02 STOP and YIELD Signs (R1-1 and R1-2)

Guidance:

STOP (R1-1) and YIELD (R1-2) signs should be considered for use on low-volume roads where engineering judgment or study indicates that either of the following conditions applies:

- A. An intersection of a less-important road with a main road where application of the normal right-of-way rule might not be readily apparent.
- B. An intersection that has restricted sight distance for the prevailing vehicle speeds.

Section 5B.03 Speed Limit Signs (R2 Series)

Standard:

If used, Speed Limit (R2 series) signs shall display the speed limit established by law, ordinance, regulation, or as adopted by the authorized agency following an engineering study. The speed limits shown shall be in multiples of 10 km/h (5 mph).

Speed limits shall be established in accordance with Section 2B.11.

Option:

Speed limit signs may be used on low-volume roads that carry traffic from, onto, or adjacent to higher-volume roads that have posted speed limits.



R1-1



R1-2



R2-1

OR



R4-1



R4-7



R5-1



R5-2



R6-2



R11-2



R11-3



R11-3a



R12-1

OR



Section 5B.04 Traffic Movement and Prohibition Signs (R3, R4, R5, R6, R9, R10, R11, R12, R13, and R14 Series)

Support:

The regulatory signs in these series inform road users of required, permitted, or prohibited traffic movements involving turn, alignment, exclusion, and pedestrians.

Standard:

If used, signs for traffic prohibitions or restrictions shall be placed in advance of the prohibition or restriction so that traffic can use an alternate route or turn around.

Guidance:

Signs should be used on low-volume roads to indicate traffic prohibitions and restrictions such as road closures and weight restrictions.

Option:

These signs may be useful on a low-volume road near and at the intersections or the connections with a higher class of road, and where the regulatory message is essential for safe transition from the low-volume road to the higher-class facility and vice versa.

Section 5B.05 Parking Signs (R8 Series)

Option:

Parking signs may be installed selectively on low-volume roads with due consideration of enforcement.

Section 5B.06 Other Regulatory Signs

Standard:

Other regulatory signs used on low-volume roads that are not discussed in Part 5 shall conform with the criteria contained in other Parts of this Manual.



R8-3



R8-3a



R8-3c
Supplemental Plaque



R8-3d
Supplemental Plaque

CHAPTER 5C. WARNING SIGNS

Section 5C.01 Introduction

Support:

The purpose of a warning sign is to provide advance warning to the road user of unexpected conditions on or adjacent to the roadway that might not be readily apparent.

The criteria for warning signs are contained in Chapter 2C and in other Sections of this Manual. Criteria for warning signs that are specific to low-volume roads are contained in this Chapter.

Section 5C.02 Horizontal Alignment Signs (W1-1 through W1-8)

Support:

Horizontal Alignment signs include turn, curve, reverse turn, reverse curve, winding road, large arrow, and chevron alignment signs.

Option:

Horizontal Alignment signs may be used where engineering judgment indicates a need to inform the road user of a change in the horizontal alignment of the roadway.

Section 5C.03 Intersection Signs (W2-1 through W2-5)

Support:

Intersection signs include the crossroad, side road, T-symbol, and Y-symbol signs.

Option:

Intersection signs may be used where engineering judgment indicates a need to inform the road user in advance of an intersection.

Section 5C.04 Stop Ahead and Yield Ahead Signs (W3-1a, W3-2a)

Standard:

A Stop Ahead (W3-1a) sign shall be used where a STOP sign is not visible for a sufficient distance to permit the road user to bring the vehicle to a stop at the STOP sign.



W1-1



W1-2



W1-3



W1-4



W1-5

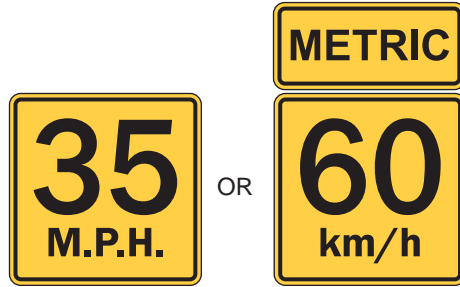

W13-1
Advisory Speed Plaque



W1-6

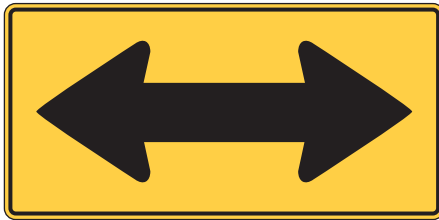

W1-7



W1-8



W2-1



W2-4



W2-5



W3-1a



W3-2a



W5-2



W5-2a



W5-3



W7-1



W7-3



W7-3a

OR



W8-3



W8-6



W11-1



W11-2



W11-3



W11-4



W11-5



W11-8



W11-10



W14-1



W14-2



W16-2

A Yield Ahead (W3-2a) sign shall be used where a YIELD sign is not visible for a sufficient distance to permit the road user to bring the vehicle to a stop, if necessary, at the YIELD sign.

Option:

Word message (W3-1 and W3-2) signs may be used as alternates to symbol signs.

Section 5C.05 Narrow Bridge Sign (W5-2a)

Option:

The Narrow Bridge (W5-2a) sign may be used on an approach to a bridge or culvert that has a clear width less than that of the approach roadway.

The word message (W5-2) sign may be used as an alternate to the symbol sign.

Section 5C.06 ONE LANE BRIDGE Sign (W5-3)

Guidance:

A ONE LANE BRIDGE (W5-3) sign should be used on low-volume roads in advance of bridges or culverts:

- A. That have a clear roadway width of less than 4.9 m (16 ft), or
- B. That have a clear roadway width of less than 5.5 m (18 ft) when commercial vehicles constitute more than ten percent of the traffic, or
- C. Where the approach sight distance is limited on the approach to a bridge or culvert having a clear roadway width of 5.5 m (18 ft) or less.

Option:

Roadway alignment and additional warning may be provided on the approach to a bridge or culvert by the use of object markers and/or delineators.

Section 5C.07 Hill Sign (W7-1a)

Option:

An engineering study of vehicles and road characteristics, such as percent grade and length of grade, may be conducted to determine hill signing requirements.

The use of the Hill sign on low-volume roads may be confined to roads where commercial or recreational vehicles are anticipated.

Word messages (W7-1) may be used as alternates to symbols.

Section 5C.08 PAVEMENT ENDS Sign (W8-3)

Option:

A PAVEMENT ENDS (W8-3) sign may be used to warn road users where a paved surface changes to a gravel or earth road surface.

Section 5C.09 Motorized Traffic and Crossing Signs (W11 Series and W8-6)

Guidance:

Motorized Traffic signs should be used to alert road users to unexpected entries into the roadway by trucks, farm vehicles, fire trucks, and other vehicles. Such signs should be used only at locations where the road user's sight distance is restricted or the activity would be unexpected.

Option:

Crossing signs may be used to alert the road user to unexpected entries into the roadway by pedestrian, bicyclist, animal, and other crossing activities that may cause potential conflicts.

A supplemental plaque (W7-3a), with the legend AHEAD, XX METERS (XX FEET), or NEXT XX KM (NEXT XX MILES) may be installed below a Motorized Traffic or Crossing sign (see Sections 2C.36 and 2C.37).

Guidance:

If the activity is seasonal or temporary, the sign should be removed or covered when the crossing activity does not exist.

Section 5C.10 Advisory Speed Plaque (W13-1)

Option:

An Advisory Speed (W13-1) plaque may be mounted below a warning sign when the condition requires a reduced speed.

Section 5C.11 DEAD END or NO OUTLET Plaques and Signs (W14-1P, W14-2P, W14-1, and W14-2)**Option:**

The DEAD END and NO OUTLET plaques and signs may be used to warn road users of a road that has no outlet or that terminates in a dead end or cul-de-sac.

Guidance:

If used, these signs or plaques should be placed at a location that gives drivers of large commercial or recreational vehicles an opportunity to select a different route or turn around.

Section 5C.12 NO TRAFFIC SIGNS Sign (W16-2)**Option:**

A warning sign (W16-2) with the legend NO TRAFFIC SIGNS may be used only on unpaved, low-volume roads to advise users that no signs are installed along the distance of the road. If used, the sign may be installed at the point where road users would enter the low-volume road or where, based on engineering judgment, the road user may need this information.

A supplemental plaque (W7-3a) with the legend AHEAD, XX METERS (XX FEET), or NEXT XX KM (NEXT XX MILES) may be installed below the W16-2 sign when appropriate.

Section 5C.13 Other Warning Signs**Standard:**

Other warning signs used on low-volume roads that are not discussed in Part 5, but are in this Manual, shall conform with the criteria contained in other Parts of this Manual. Warning signs that are not specified in this Manual shall conform to the criteria in Sections 2C.02 and 2C.03.

CHAPTER 5D. GUIDE SIGNS

Section 5D.01 Introduction

Support:

The purpose of a guide sign is to inform road users regarding positions, directions, destinations, and routes.

The criteria for guide signs, in general, are contained in Chapters 2D through 2H and in other Sections of this Manual. Criteria for guide signs that are specific to low-volume roads are contained in this Chapter.

Guidance:

The familiarity of the road users with the road should be considered in determining the need for guide signs on low-volume roads.

Support:

Low-volume roads generally do not require guide signs to the extent that they are needed on higher classes of roads. Because guide signs are typically only beneficial as a navigational aid for road users who are unfamiliar with a low-volume road, guide signs might not be needed on low-volume roads that serve only local traffic.

Guidance:

If used, destination names should be as specific and descriptive as possible. Destinations such as campgrounds, ranger stations, recreational areas, and the like should be clearly indicated so that they are not interpreted to be communities or locations with road user services.

Option:

Guide signs may be used at intersections to provide information for road users returning to a higher class of roads.

CHAPTER 5E. MARKINGS

Section 5E.01 Introduction

Support:

The purpose of markings on highways is to provide guidance and information for road users regarding roadway conditions and restrictions.

The criteria for markings, delineators, and object markers, in general, are contained in Part 3 and in other Sections of this Manual. Criteria for markings that are specific to low-volume roads are contained in this Chapter.

Section 5E.02 Centerline Markings

Standard:

Where centerline markings are installed, no-passing zone markings in conformance with Section 3B.02 shall also be installed.

Guidance:

Centerline markings should be used on paved low-volume roads where engineering judgment or an engineering study indicates a need for them.

Section 5E.03 Edge Line Markings

Support:

The purpose of edge line markings is to delineate the left or right edge of the roadway.

Guidance:

Edge line markings should be considered for use on paved low-volume roads based on engineering judgment or an engineering study.

Option:

Edge line markings may be placed on highways with or without centerline markings.

Edge line markings may be placed on paved low-volume roads for roadway features such as horizontal curves, narrow bridges, pavement width transitions, curvilinear alignment, and at other locations based on engineering judgment or an engineering study.

Section 5E.04 Delineators

Support:

The purpose of delineators is to enhance driver safety where it is desirable to call attention to a changed or changing condition such as abrupt roadway narrowing or curvature.

Option:

Delineators may be used on low-volume roads based on engineering judgment, such as for curves, T-intersections, and abrupt changes in the roadway width. In addition, they may be used to mark the location of driveways or other minor roads entering the low-volume road.

Section 5E.05 Object Markers

Support:

The purpose of object markers is to mark obstructions located within or adjacent to the roadway, such as bridge abutments, drainage structures, and other physical objects.

Guidance:

The end of a low-volume road should be marked with an end-of-roadway marker in conformance with Section 3C.04.

Option:

A Type III barricade may be used where engineering studies or judgment indicates a need for a more visible end-of-roadway treatment (see Section 3F.01).

Section 5E.06 Other Markings

Standard:

Other markings, such as stop lines, crosswalks, pavement legends, barricades, channelizing devices, and islands, used on low-volume roads shall conform with the criteria contained in this Manual.

CHAPTER 5F. TRAFFIC CONTROL FOR HIGHWAY-RAIL GRADE CROSSINGS

Section 5F.01 Introduction

Support:

The criteria for these traffic control devices are contained in Part 8 and in other Sections of this Manual.

Traffic control for highway-rail grade crossings includes all signs, signals, markings, illumination, and other warning devices and their supports along roadways either approaching or at highway-rail grade crossings. The function of this traffic control is to permit safe and efficient operation of both rail and road traffic at highway-rail grade crossings.

Section 5F.02 Highway-Rail Grade Crossing (Crossbuck) Sign (R15-1, R15-2)

Standard:

The Highway-Rail Grade Crossing (Crossbuck) (R15-1) sign shall be used at all highway-rail grade crossings. For all low-volume roads, Crossbucks signs shall be used on the right side of each approach. If there are two or more tracks, the supplemental Number of Tracks (R15-2) sign shall display the number of tracks and shall be installed below the Crossbuck sign.

A strip of retroreflective white material not less than 50 mm (2 in) in width shall be mounted on the back of each blade of each Crossbuck sign for the length of each blade. Also, a similar 50 mm (2 in) strip shall be used for the full length of the front and back of each support from the Crossbuck sign/Number of Tracks sign to near ground level.

Section 5F.03 Highway-Rail Grade Crossing Advance Warning Signs (W10 Series)

Standard:

Except as noted in the Option, a Highway-Rail Grade Crossing Advance Warning (W10-1) sign shall be used on all low-volume roads in advance of every highway-rail grade crossing.

Option:

The Highway-Rail Grade Crossing Advance Warning sign may be omitted for highway-rail grade crossings that are flagged by train crews.



R15-1



R15-2



W10-1

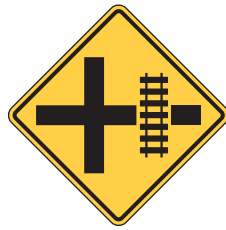

W10-2

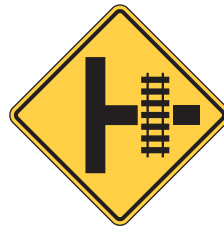

W10-3

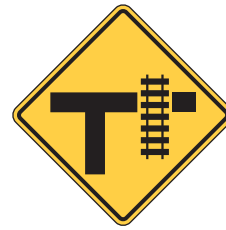

W10-4

The W10-2, W10-3, and W10-4 signs may be used on low-volume roads that run parallel to railroad tracks to warn road users making a turn that they will encounter a highway-rail grade crossing soon after making the turn.

Section 5F.04 STOP and YIELD Signs

Option:

STOP (R1-1) or YIELD (R1-2) signs may be used at low-volume highway-rail grade crossings, at the discretion of the responsible State or local jurisdiction, for crossings without automatic traffic control devices.

Standard:

A Stop Ahead (W3-1) sign or Yield Ahead (W3-2) sign shall be used in advance of a STOP or YIELD sign at a highway-rail grade crossing if the STOP or YIELD sign is not visible for a distance that enables the road user to bring the vehicle to a safe stop at the highway-rail grade crossing.

Section 5F.05 Pavement Markings

Guidance:

Pavement markings at highway-rail grade crossings should be used on paved low-volume roads, particularly if they are already deployed at most other highway-rail grade crossings within the immediate vicinity, or when the roadway has centerline markings.

Section 5F.06 Other Traffic Control Devices

Standard:

Other traffic control devices that are used at highway-rail grade crossings on low-volume roads, such as other signs, signals, and illumination that are not in this Chapter, shall conform with the criteria contained in Part 8 and other applicable Parts of this Manual.

CHAPTER 5G. TEMPORARY TRAFFIC CONTROL ZONES

Section 5G.01 Introduction

Guidance:

The safety of road users, including pedestrians and bicyclists, as well as personnel in work zones, should be an integral and high priority element of every project in the planning, design, maintenance, and construction phases. Part 6 should be reviewed for additional criteria, specific details, and more complex temporary traffic control zone requirements. The following principles should be applied to temporary traffic control zones:

- A. Traffic movement should be disrupted as little as possible.
- B. Road users should be guided in a clear and positive manner while approaching and within construction, maintenance, and utility work areas.
- C. Routine inspection and maintenance of traffic control elements should be performed both day and night.
- D. Both the contracting agency and the contractor should assign at least one person on each project to have day-to-day responsibility for assuring that the traffic control elements are operating effectively and that any needed operational changes are brought to the attention of their supervisors.

Traffic control in temporary traffic control zones should be designed on the assumption that road users will only reduce their speeds if they clearly perceive a need to do so, and then only in small increments of speed. Temporary traffic control zones should not present a surprise to the road user. Frequent and/or abrupt changes in geometrics and other features should be avoided. Transitions should be well delineated and long enough to accommodate driving conditions at the speeds vehicles are realistically expected to travel.

A Traffic Control Plan (see Section 6C.01) should be used for a temporary traffic control zone on a low-volume road to specify particular traffic control devices and features, or to reference typical drawings such as those contained in Part 6.

Support:

Applications of speed reduction countermeasures and enforcement can be effective in reducing traffic speeds in temporary traffic control zones.



W8-7



W8-12



OR



W13-1
Advisory Speed Plaque



W14-3



OR



W20-1



W20-7a



W20-7b



W21-1a



W21-2



W21-3



W21-5



W21-6



OR



W16-1
Supplemental Plaque

Section 5G.02 Applications**Guidance:**

Planned work phasing and sequencing should be the basis for the use of traffic control devices for temporary traffic control zones. Part 6 should be consulted for specific traffic control requirements and examples where construction or maintenance work is planned.

Option:

Maintenance activities may not require extensive temporary traffic control if the traffic volumes and speeds are low. The traffic applications shown in Figures 6H-1, 6H-11, 6H-15, and 6H-16 of Part 6 are among those that may be used on low-volume roads.

For temporary traffic control zones on low-volume roads that require flaggers, a single flagger may be adequate if the flagger is visible to approaching traffic from all appropriate directions.

Section 5G.03 Channelization Devices**Standard:**

Channelization devices for nighttime use shall have the same retroreflective requirements as specified for higher-volume roadways.

Option:

To alert, guide and direct road users safely through temporary traffic control zones on low-volume roads, tapers may be used to move a road user out of the traffic lane and around the temporary traffic control zone using the spacing of devices that is described in Section 6F.55.

Section 5G.04 Markings**Guidance:**

Pavement markings should be considered for temporary traffic control zones on paved low-volume roads, especially roads that had existing pavement markings, or that have a surfaced detour or temporary roadway.

Option:

Interim pavement markings in a temporary traffic control zone may not be needed based on the criteria for these markings in Section 6F.66.

Section 5G.05 Other Traffic Control Devices

Standard:

Other traffic control devices, such as other signs, signals, and illumination that are used on low-volume roads in temporary traffic control zones, but are not described in Part 5, shall conform with the criteria contained in other Parts of this Manual.

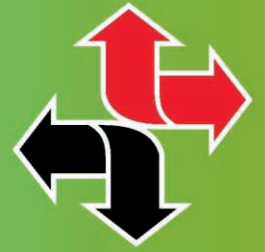

PART 6

Temporary Traffic Control

MUTCD 2000

Manual on Uniform Traffic Control Devices

m i l l e n n i u m e d i t i o n

December 2000



U.S. Department
of Transportation

**Federal Highway
Administration**

PART 6. TEMPORARY TRAFFIC CONTROL**TABLE OF CONTENTS**

	<u>Page</u>
CHAPTER 6A. GENERAL	Dec., 2000
Section 6A.01 General	6A-1
CHAPTER 6B. FUNDAMENTAL PRINCIPLES	Dec., 2000
Section 6B.01 Fundamental Principles of Temporary Traffic Control	6B-1
CHAPTER 6C. TEMPORARY TRAFFIC CONTROL ELEMENTS Dec., 2000	
Section 6C.01 Temporary Traffic Control Plans	6C-1
Section 6C.02 Temporary Traffic Control Zones	6C-2
Section 6C.03 Components of Temporary Traffic Control Zones	6C-3
Section 6C.04 Advance Warning Area	6C-3
Section 6C.05 Transition Area	6C-5
Section 6C.06 Activity Area	6C-6
Section 6C.07 Termination Area	6C-7
Section 6C.08 Tapers	6C-9
Section 6C.09 Detours and Diversions	6C-11
Section 6C.10 One-Lane, Two-Way Traffic Control	6C-11
Section 6C.11 Flagger Method of One-Lane, Two-Way Traffic Control	6C-13
Section 6C.12 Flag Transfer Method of One-Lane, Two-Way Traffic Control	6C-13
Section 6C.13 Pilot Car Method of One-Lane, Two-Way Traffic Control	6C-14
Section 6C.14 Temporary Traffic Control Signal Method of One-Lane, Two-Way Traffic Control	6C-14
Section 6C.15 Stop or Yield Control Method of One-Lane, Two-Way Traffic Control	6C-14
CHAPTER 6D. PEDESTRIAN AND WORKER SAFETY	Dec., 2000
Section 6D.01 Pedestrian Considerations	6D-1
Section 6D.02 Worker Considerations	6D-4
CHAPTER 6E. FLAGGER CONTROL	Dec., 2000
Section 6E.01 Qualifications for Flaggers	6E-1
Section 6E.02 High-Visibility Clothing	6E-1
Section 6E.03 Hand-Signaling Devices	6E-2

Section 6E.04 Flagger Procedures6E-3
 Section 6E.05 Flagger Stations6E-5

**CHAPTER 6F. TEMPORARY TRAFFIC CONTROL
 ZONE DEVICESDec., 2000**

Section 6F.01 Types of Devices6F-1
 Section 6F.02 General Characteristics of Signs6F-1
 Section 6F.03 Sign Placement.....6F-3
 Section 6F.04 Sign Maintenance.....6F-7
 Section 6F.05 Regulatory Sign Authority6F-7
 Section 6F.06 Regulatory Sign Design6F-7
 Section 6F.07 Regulatory Sign Applications6F-7
 Section 6F.08 ROAD (STREET) CLOSED Sign (R11-2)6F-11
 Section 6F.09 Local Traffic Only Signs (R11-3a, R11-4)6F-11
 Section 6F.10 Weight Limit Signs (R12-1, R12-2, R12-5)6F-12
 Section 6F.11 STAY IN LANE Sign (R4-9).....6F-12
 Section 6F.12 PEDESTRIAN CROSSWALK Sign (R9-8).....6F-12
 Section 6F.13 SIDEWALK CLOSED Signs (R9-9, R9-10, R9-11, R9-11a)6F-12
 Section 6F.14 Special Regulatory Signs6F-13
 Section 6F.15 Warning Sign Function, Design, and Application6F-13
 Section 6F.16 Position of Advance Warning Signs6F-21
 Section 6F.17 ROAD (STREET) WORK Sign (W20-1)6F-22
 Section 6F.18 DETOUR Sign (W20-2)6F-22
 Section 6F.19 ROAD (STREET) CLOSED Sign (W20-3)6F-23
 Section 6F.20 ONE LANE ROAD Sign (W20-4)6F-23
 Section 6F.21 LANE(S) CLOSED Signs (W20-5, W20-5a).....6F-23
 Section 6F.22 CENTER LANE CLOSED AHEAD Signs (W9-3, W9-3a)6F-24
 Section 6F.23 THRU TRAFFIC MERGE RIGHT (LEFT) Sign (W4-1a).....6F-24
 Section 6F.24 Lane Reduction Sign (W4-2).....6F-24
 Section 6F.25 ON RAMP Plaque (W13-4).....6F-24
 Section 6F.26 RAMP NARROWS Sign (W5-4)6F-24
 Section 6F.27 SLOW TRAFFIC AHEAD Sign (W23-1).....6F-25
 Section 6F.28 EXIT OPEN, EXIT CLOSED Signs (E5-2, E5-2a)6F-25
 Section 6F.29 Flagger Sign (W20-7, W20-7a)6F-25
 Section 6F.30 Two-Way Traffic Sign (W6-3).....6F-25
 Section 6F.31 Workers Sign (W21-1, W21-1a)6F-26
 Section 6F.32 FRESH OIL (TAR) Sign (W21-2).....6F-26
 Section 6F.33 ROAD MACHINERY AHEAD Sign (W21-3)6F-26
 Section 6F.34 SHOULDER WORK Signs (W21-5, W21-5a, W21-5b)6F-26
 Section 6F.35 SURVEY CREW Sign (W21-6)6F-27
 Section 6F.36 UTILITY WORK Sign (W21-7).....6F-27
 Section 6F.37 Signs for Blasting Areas6F-28
 Section 6F.38 BLASTING ZONE AHEAD Sign (W22-1)6F-28
 Section 6F.39 TURN OFF 2-WAY RADIO AND PHONE Sign (W22-2)6F-28
 Section 6F.40 END BLASTING ZONE Sign (W22-3).....6F-29
 Section 6F.41 SHOULDER DROP-OFF Sign (W8-9a).....6F-29
 Section 6F.42 UNEVEN LANES Sign (W8-11)6F-29

Section 6F.43	NO CENTER STRIPE Sign (W8-12).....	6F-29
Section 6F.44	Other Warning Signs	6F-29
Section 6F.45	Advisory Speed Plaque (W13-1)	6F-30
Section 6F.46	Supplementary Distance Plaque (W7-3a).....	6F-30
Section 6F.47	Guide Signs	6F-31
Section 6F.48	ROAD WORK NEXT XX KM (MILES) Sign (G20-1).....	6F-32
Section 6F.49	END ROAD WORK Sign (G20-2a).....	6F-32
Section 6F.50	Detour Signs and Markers (M4-8, M4-8a, M4-8b, M4-9, and M4-10).....	6F-32
Section 6F.51	PILOT CAR FOLLOW ME Sign (G20-4)	6F-33
Section 6F.52	Portable Changeable Message Signs	6F-33
Section 6F.53	Arrow Panels.....	6F-36
Section 6F.54	High-Level Warning Devices (Flag Trees).....	6F-40
Section 6F.55	Channelizing Devices	6F-41
Section 6F.56	Cones.....	6F-44
Section 6F.57	Tubular Markers.....	6F-45
Section 6F.58	Vertical Panels.....	6F-46
Section 6F.59	Drums	6F-47
Section 6F.60	Type I, II, or III Barricades	6F-48
Section 6F.61	Direction Indicator Barricades	6F-50
Section 6F.62	Temporary Traffic Barriers as Channelizing Devices.....	6F-51
Section 6F.63	Temporary Raised Islands	6F-51
Section 6F.64	Opposing Traffic Lane Divider.....	6F-52
Section 6F.65	Pavement Markings.....	6F-52
Section 6F.66	Temporary Pavement Markings	6F-53
Section 6F.67	Raised Pavement Markers.....	6F-54
Section 6F.68	Delineators	6F-55
Section 6F.69	Lighting Devices	6F-55
Section 6F.70	Floodlights.....	6F-56
Section 6F.71	Flashing Warning Beacons.....	6F-56
Section 6F.72	Warning Lights.....	6F-57
Section 6F.73	Steady-Burn Electric Lamps	6F-58
Section 6F.74	Temporary Traffic Control Signals	6F-59
Section 6F.75	Temporary Traffic Barriers	6F-61
Section 6F.76	Crash Cushions	6F-62
Section 6F.77	Vehicle-Arresting Systems.....	6F-63
Section 6F.78	Rumble Strips.....	6F-64
Section 6F.79	Screens	6F-64
Section 6F.80	Future and Experimental Devices.....	6F-65

CHAPTER 6G. TYPE OF TEMPORARY TRAFFIC CONTROL ZONE ACTIVITIESDec., 2000

Section 6G.01	Typical Applications.....	6G-1
Section 6G.02	Work Duration	6G-1
Section 6G.03	Location of Work.....	6G-5
Section 6G.04	Modifications to Fulfill Special Needs	6G-5
Section 6G.05	Work Outside of Shoulder.....	6G-7

Section 6G.06 Work on the Shoulder with No Encroachment6G-8
 Section 6G.07 Work on the Shoulder with Minor Encroachment6G-9
 Section 6G.08 Work Within the Median6G-10
 Section 6G.09 Work Within the Traveled Way of Two-Lane Highways6G-10
 Section 6G.10 Work Within the Traveled Way of Urban Streets.....6G-11
 Section 6G.11 Work Within the Traveled Way of Multi-Lane, Non-Access
 Controlled Highways.....6G-12
 Section 6G.12 Work Within the Traveled Way at an Intersection6G-14
 Section 6G.13 Work Within the Traveled Way of Expressways and Freeways6G-16
 Section 6G.14 Two-Lane, Two-Way Traffic on One Roadway of a Normally
 Divided Highway6G-17
 Section 6G.15 Crossovers6G-18
 Section 6G.16 Interchanges.....6G-18
 Section 6G.17 Movable Barriers6G-19
 Section 6G.18 Work in the Vicinity of Highway-Rail Grade Crossings6G-19
 Section 6G.19 Control of Traffic Through Incident Areas6G-19

CHAPTER 6H. TYPICAL APPLICATIONSDec., 2000

Section 6H.01 Typical Applications6H-1

FIGURES

CHAPTER 6C. TEMPORARY TRAFFIC CONTROL ELEMENTS

Figure 6C-1 Component Parts of a Temporary Traffic Control Zone6C-4
 Figure 6C-2 Types of Tapers and Buffer Spaces6C-8
 Figure 6C-3 Example of a One-Lane Two-Way Traffic Taper6C-12

CHAPTER 6E. FLAGGER CONTROL

Figure 6E-1 Use of Hand-Signaling Devices by Flaggers.....6E-4

CHAPTER 6F. TEMPORARY TRAFFIC CONTROL ZONE DEVICES

Figure 6F-1 Height and Lateral Location of Signs - Typical Installations6F-4
 Figure 6F-2 Methods of Mounting Signs Other Than on Posts6F-6
 Figure 6F-3 Advance Warning Arrow Display Specifications6F-38
 Figure 6F-4 Channelizing Devices6F-42

CHAPTER 6H. TYPICAL APPLICATIONS

Figure 6H-1	Work Beyond the Shoulder (TA-1)	6H-7
Figure 6H-2	Blasting Zone (TA-2)	6H-9
Figure 6H-3	Work on Shoulders (TA-3)	6H-11
Figure 6H-4	Short Duration or Mobile Operation on Shoulder (TA-4)	6H-13
Figure 6H-5	Shoulder Closure on Freeway (TA-5)	6H-15
Figure 6H-6	Shoulder Work with Minor Encroachment (TA-6)	6H-17
Figure 6H-7	Road Closure with Diversion (TA-7)	6H-19
Figure 6H-8	Road Closure with Off-Site Detour (TA-8)	6H-21
Figure 6H-9	Overlapping Routes with Detour (TA-9)	6H-23
Figure 6H-10	Lane Closure on Two-Lane Road Using Flaggers (TA-10)	6H-25
Figure 6H-11	Lane Closure on Two-Volume Two-Lane Road (TA-11)	6H-27
Figure 6H-12	Lane Closure on Two-Lane Road Using Traffic Control Signals (TA-12)	6H-29
Figure 6H-13	Temporary Road Closure (TA-13)	6H-31
Figure 6H-14	Haul Road Crossing (TA-14)	6H-33
Figure 6H-15	Work in Center of Low-Volume Road (TA-15)	6H-35
Figure 6H-16	Surveying Along Centerline of Low-Volume Road (TA-16)	6H-37
Figure 6H-17	Mobile Operations on Two-Lane Road (TA-17)	6H-39
Figure 6H-18	Lane Closure on Minor Street (TA-18)	6H-41
Figure 6H-19	Detour for One Travel Direction (TA-19)	6H-43
Figure 6H-20	Detour for Closed Street (TA-20)	6H-45
Figure 6H-21	Lane Closure on Near Side of Intersection (TA-21)	6H-47
Figure 6H-22	Right Lane Closure on Far Side of Intersection (TA-22)	6H-49
Figure 6H-23	Left Lane Closure on Far Side of Intersection (TA-23)	6H-51
Figure 6H-24	Half Road Closure on Far Side of Intersection (TA-24)	6H-53
Figure 6H-25	Multiple Lane Closures at Intersection (TA-25)	6H-55
Figure 6H-26	Closure in Center of Intersection (TA-26)	6H-57
Figure 6H-27	Closure at Side of Intersection (TA-27)	6H-59
Figure 6H-28	Sidewalk Detour or Diversion (TA-28)	6H-61
Figure 6H-29	Crosswalk Closures and Pedestrian Detours (TA-29)	6H-63
Figure 6H-30	Interior Lane Closure on Multi-Lane Street (TA-30)	6H-65
Figure 6H-31	Lane Closures on Street with Uneven Directional Volumes (TA-31)	6H-67
Figure 6H-32	Half Road Closure on Multi-Lane, High-Speed Highway (TA-32)	6H-69
Figure 6H-33	Stationary Lane Closure on Divided Highway (TA-33)	6H-71
Figure 6H-34	Lane Closure with Temporary Traffic Barrier (TA-34)	6H-73
Figure 6H-35	Mobile Operation on Multi-Lane Road (TA-35)	6H-75
Figure 6H-36	Lane Shift on Freeway (TA-36)	6H-77
Figure 6H-37	Double Lane Closure on Freeway (TA-37)	6H-79
Figure 6H-38	Interior Lane Closure on Freeway (TA-38)	6H-81
Figure 6H-39	Median Crossover on Freeway (TA-39)	6H-83
Figure 6H-40	Median Crossover for Entrance Ramp (TA-40)	6H-85
Figure 6H-41	Median Crossover for Exit Ramp (TA-41)	6H-87
Figure 6H-42	Work in Vicinity of Exit Ramp (TA-42)	6H-89
Figure 6H-43	Partial Exit Ramp Closure (TA-43)	6H-91
Figure 6H-44	Work in Vicinity of Entrance Ramp (TA-44)	6H-93
Figure 6H-45	Movable Barriers (TA-45)	6H-95
Figure 6H-46	Work in Vicinity of Highway-Rail Grade-Crossing (TA-46)	6H-97

TABLES

CHAPTER 6C. TRAFFIC CONTROL PLANS

Table 6C-1	Suggested Advance Warning Sign Spacing.....	6C-5
Table 6C-2	Taper Length Criteria for Temporary Traffic Control Zones	6C-10

CHAPTER 6E. FLAGGER CONTROL

Table 6E-1	Distance of Flagger Station in Advance of the Work Space	6E-6
------------	--	------

CHAPTER 6H. TYPICAL APPLICATIONS

Table 6H-1	Index to Typical Application Diagrams	6H-2
Table 6H-2	Meaning of Symbols on Typical Application Diagrams	6H-4
Table 6H-3	Meaning of Letter Codes on Typical Application Diagrams	6H-5

CHAPTER 6A. GENERAL

Section 6A.01 General

Support:

When the normal function of the roadway is suspended, temporary traffic control planning provides for continuity of the movement of motor vehicle, bicycle, and pedestrian traffic; transit operations; and access to property and utilities.

The primary function of temporary traffic control is to provide for the safe and efficient movement of vehicles, bicyclists, and pedestrians through or around temporary traffic control zones while reasonably protecting workers and equipment.

Of equal importance to the public traveling through the temporary traffic control zone is the safety of workers performing the many varied tasks within the work space. Temporary traffic control zones present constantly changing conditions that are unexpected by the road user. This creates an even higher degree of vulnerability for the workers on or near the roadway (see Section 6D.02). At the same time, the temporary traffic control zone provides for the efficient completion of whatever activity interrupted the normal use of the roadway.

Consideration for road user safety, worker safety, and the efficiency of road user flow is an integral element of every temporary traffic control zone, from planning through completion. A concurrent objective of the temporary traffic control is the efficient construction and maintenance of the highway.

No one set of temporary traffic control devices can satisfy all conditions for a given project. At the same time, defining details that would be adequate to cover all applications is not practical. Instead, Part 6 displays typical applications that depict common applications of temporary traffic control devices. The temporary traffic control selected for each situation depends on type of highway, road user conditions, duration of operation, physical constraints, and the nearness of the work space to road users.

Improved road user performance might be realized through a well-prepared public relations effort that covers the nature of the work, the time and duration of its execution, the anticipated effects upon road users, and possible alternate routes and modes of travel. Such programs have been found to result in a significant reduction in the number of road users traveling through the temporary traffic zone, which reduces the possible number of conflicts.

Standard:

Temporary traffic control plans and devices shall be the responsibility of the authority of a public body or official having jurisdiction for guiding road users. There shall be adequate statutory authority for the implementation and enforcement of needed road user regulations, parking controls, speed zoning, and

incident management. Such statutes shall provide sufficient flexibility in the application of temporary traffic control to meet the needs of changing conditions in the temporary traffic control zone.

Guidance:

The temporary traffic control plan should start in the planning phase and continue through the design, construction, and restoration phases. The temporary traffic control plans and devices should follow the principles set forth in Part 6.

Option:

Temporary traffic control plans may deviate from the typical applications described in Chapter 6H to allow for conditions and requirements of a particular site or jurisdiction.

Support:

The criteria of Part 6 apply to both rural and urban areas. A rural highway is normally characterized by lower volumes, higher speeds, fewer turning conflicts, and less conflict with pedestrians. An urban street is typically characterized by relatively low speeds, wide ranges of road user volumes, narrower roadway lanes, frequent intersections and driveways, significant pedestrian activity, and more businesses and houses.

CHAPTER 6B. FUNDAMENTAL PRINCIPLES

Section 6B.01 Fundamental Principles of Temporary Traffic Control

Standard:

The control of road users through a temporary traffic control zone shall be an essential part of highway construction, utility work, maintenance operations, and incident management.

Support:

Construction, maintenance, utility, and incident zones can all benefit from temporary traffic control to compensate for the unexpected or unusual situations faced by road users. When planning for temporary traffic control in these zones, it can be assumed that is appropriate for road users to exercise extra caution. Even though road users are assumed to be using extra caution, special care is still needed in applying temporary control techniques.

Special plans preparation and coordination with transit, other highway agencies, police and other emergency units, utilities, schools, and railroad companies might be needed to reduce unexpected and unusual road user operation situations.

During temporary traffic control activities, commercial vehicles might need to follow a different route from passenger vehicles because of bridge, weight, clearance, or geometric restrictions. Also, vehicles carrying hazardous materials might need to follow a different route from other vehicles. The Truck Route National Network and hazardous materials signs are included in Section 2B.45.

Experience has shown that following the fundamental principles of Part 6 will assist road users and help protect workers in the vicinity of temporary traffic control zones. While these principles provide guidance for good temporary traffic control for the practitioner, they do not establish standards and warrants.

Guidance:

Road user and worker safety in temporary traffic control zones should be an integral and high-priority element of every project from planning through design and construction. Similarly, maintenance and utility work should be planned and conducted with the safety of drivers, bicyclists, pedestrians, and workers being considered at all times. If the temporary traffic control zone includes a highway-rail grade crossing, early coordination with the railroad company should take place.

Support:

Formulating specific plans for incident management temporary traffic control is difficult because of the variety of situations that can arise.

Guidance:

General plans or guidelines should be developed to provide safety for drivers, bicyclists, pedestrians, workers, enforcement/emergency officials, and equipment, with the following factors being considered:

- A. The basic safety principles governing the design of permanent roadways and roadsides should also govern the design of temporary traffic control zones. The goal should be to route road users through such zones using roadway geometrics, roadside features, and temporary traffic control devices as nearly as possible comparable to those for normal highway situations.
- B. A temporary traffic control plan, in detail appropriate to the complexity of the work project or incident, should be prepared and understood by all responsible parties before the site is occupied. Any changes in the temporary traffic control plan should be approved by an official knowledgeable (for example, trained and/or certified) in proper temporary traffic control practices.

Road user movement should be inhibited as little as practical, based on the following considerations:

- A. Temporary traffic control at work and incident sites should be designed on the assumption that drivers will only reduce their speeds if they clearly perceive a need to do so (see Section 6C.01).
- B. Frequent and abrupt changes in geometrics such as lane narrowing, dropped lanes, or main roadway transitions that require rapid maneuvers, should be avoided.
- C. Provisions should be made for the reasonably safe operation of work, particularly on high-speed, high-volume roadways.
- D. Road users should be encouraged to use alternative routes that do not include temporary traffic control zones.
- E. Bicyclists and pedestrians should be provided with access and reasonably safe passage through the temporary traffic control zone.
- F. Roadway occupancy should be scheduled during off-peak hours and, if necessary, night work should be considered.
- G. Early coordination with officials having jurisdiction over the affected cross streets and providing emergency services should occur before roadway or ramp closings.

Drivers, bicyclists, and pedestrians should be guided in a clear and positive manner while approaching and traversing temporary traffic control zones and incident sites. The following principles should be applied:

- A. Adequate warning, delineation, and channelization should be provided to assist in guiding road users in advance of and through the temporary traffic control zone or incident site by using proper pavement marking, signing, or other devices that are effective under varying conditions.
- B. Temporary traffic control devices inconsistent with intended travel paths through temporary traffic control zones should be removed or covered. However, in intermediate-term stationary, short-term, and mobile operations, where visible permanent devices are inconsistent with intended travel paths, devices that highlight or emphasize the appropriate path should be used.
- C. Flagging procedures, when used, should provide positive guidance to road users traversing the temporary traffic control zone.

To provide acceptable levels of operations, routine day and night inspections of temporary traffic control elements should be performed as follows:

- A. Individuals who are knowledgeable (for example, trained and/or certified) in the principles of proper temporary traffic control should be assigned responsibility for safety in temporary traffic control zones. The most important duty of these individuals should be to check that all temporary traffic control devices of the project are reasonably consistent with the temporary traffic control plan and are effective in providing safe conditions for drivers, bicyclists, pedestrians, and workers.
- B. As the work progresses, temporary traffic controls and/or working conditions should be modified in order to provide safe and efficient road user movement and to promote worker safety. The individual responsible for temporary traffic control should have the authority to halt work until applicable or remedial safety measures are taken.
- C. Temporary traffic control zones should be carefully monitored under varying conditions of road user volumes, light, and weather to check that applicable temporary traffic control devices are effective, clearly visible, clean, and in compliance with the temporary traffic control plan.
- D. When warranted, an engineering study should be made (in cooperation with law enforcement officials) of reported crashes occurring within the temporary traffic control zone. Crash records in temporary traffic control zones should be monitored to identify the need for changes in the temporary traffic control zone.

Attention should be given to the maintenance of roadside safety during the life of the temporary traffic control zone by applying the following principles:

- A. To accommodate run-off-the-road incidents, disabled vehicles, or emergency situations, unencumbered roadside recovery areas or clear zones should be provided where practical.
- B. Channelization of road users should be accomplished by the use of pavement markings, signing, and crashworthy channelizing devices.
- C. Work equipment, workers' private vehicles, materials, and debris should be stored in such a manner to reduce the probability of being impacted by run-off-the-road vehicles.

Each person whose actions affect temporary traffic control zone safety, from the upper-level management through the field workers, should receive training appropriate to the job decisions each individual is required to make. Only those individuals who are trained in proper temporary traffic control practices and have a basic understanding of the principles (established by applicable standards and guidelines, including those of this Manual) should supervise the selection, placement, and maintenance of temporary traffic control devices used for temporary traffic control zones and for incident management.

Good public relations should be maintained by applying the following principles:

- A. The cooperation of the various news media in publicizing the existence of and reasons for temporary traffic control zones should be sought as news releases can assist in keeping the road users well informed.
- B. The needs of abutting property owners, residents, and businesses should be assessed and appropriate accommodations made.
- C. The needs of emergency service providers (police, fire, and medical) should be assessed and appropriate coordination and accommodations made.
- D. The needs of railroads and transit should be assessed and appropriate coordination and accommodations made.

Standard:

All temporary traffic control devices shall be removed as soon as practical when they are no longer needed. When work is suspended for short periods of time, temporary traffic control devices that are no longer appropriate shall be removed or covered.

CHAPTER 6C. TEMPORARY TRAFFIC CONTROL ELEMENTS

Section 6C.01 Temporary Traffic Control Plans

Support:

A temporary traffic control plan describes temporary traffic control measures to be used for facilitating road users through a work zone. Temporary traffic control plans play a vital role in providing continuity of safe and efficient road user flow when a work zone, incident, or other events temporarily disrupt normal road user flow. Important auxiliary provisions that cannot conveniently be specified on project plans can easily be incorporated into Special Provisions within the temporary traffic control plan.

Temporary traffic control plans range in scope from being very detailed to simply referencing typical drawings contained in this Manual, standard approved highway agency drawings and manuals, or specific drawings contained in the contract documents. The degree of detail in the temporary traffic control plan depends entirely on the complexity of the situation.

Guidance:

Temporary traffic control plans should be prepared by persons knowledgeable (for example, trained and/or certified) about the fundamental principles of temporary traffic control and work activities to be performed. The design, selection and placement of temporary traffic control devices for a temporary traffic control plan should be based on engineering judgment.

Coordination should be made between adjacent or overlapping projects to check that duplicate signing is not used and to check compatibility of traffic control between adjacent or overlapping projects.

Traffic control planning should be completed for all highway construction, utility work, maintenance operations, and incident management including minor maintenance and utility projects prior to occupying the temporary traffic control zone.

Option:

Provisions may be incorporated into the project bid documents that enable contractors to develop an alternate temporary traffic control plan.

Modifications of temporary traffic control plans may be necessary because of changed conditions or a determination of better methods of safely and efficiently handling road users.

Guidance:

This alternate or modified plans should have the approval of the responsible highway agency prior to implementation.

Provisions for effective continuity of transit service should be incorporated into the temporary traffic control planning process. Oftentimes, public transit buses cannot efficiently be detoured in the same manner as other vehicles (particularly for short-term maintenance projects). The temporary traffic control plan should provide for features such as temporary bus stops, pull out, and satisfactory waiting areas for transit patrons, if applicable (see Section 10A.05 for additional light rail transit issues to consider for temporary traffic control).

Provisions for effective continuity of railroad service and acceptable access to abutting property owners and businesses should also be incorporated into the temporary traffic control planning process.

Reduced speed limits should be used only in the specific portion of the temporary traffic control zone where conditions or restrictive features are present. However, frequent changes in the speed limit should be avoided. A temporary traffic control plan should be designed so that vehicles can safely travel through the temporary traffic control zone with a speed limit reduction of no more than 16 km/h (10 mph).

A reduction of more than 16 km/h (10 mph) in the speed limit should be used only when required by restrictive features in the temporary traffic control zone. Where restrictive features justify a speed reduction of more than 16 km/h (10 mph), additional driver notification should be provided. The speed limit should be stepped down in advance of the location requiring the lowest speed, and additional temporary traffic control warning devices should be used.

Reduced speed zoning (lowering the regulatory speed limit) should be avoided as much as practical because drivers will reduce their speeds only if they clearly perceive a need to do so.

Support:

Research has demonstrated that large reductions in the speed limit, such as a 50 km/h (30 mph) reduction, increase speed variance and the potential for crashes. Smaller reductions in the speed limit of up to 16 km/h (10 mph) cause smaller changes in speed variance and lessen the potential for increased crashes. A reduction in the regulatory speed limit of only up to 16 km/h (10 mph) from the normal speed limit has been shown to be more effective.

Section 6C.02 Temporary Traffic Control Zones

Support:

A temporary traffic control zone is an area of a highway where road user conditions are changed because of a work zone or an incident through the use of temporary traffic control devices, police, or other authorized officials.

A work zone is an area of a highway with construction, maintenance, or utility work activities. A work zone is typically marked by signs, channelizing devices, barriers, pavement markings, and/or work vehicles. It extends from the first warning sign or rotating/strobe lights on a vehicle to the END ROAD WORK sign or the last temporary traffic control device.

An incident area is an area of a highway where temporary traffic controls are imposed by authorized officials in response to a road user incident, natural disaster, or special event.

Section 6C.03 Components of Temporary Traffic Control Zones

Support:

Most temporary traffic control zones are divided into four areas: the advance warning area, the transition area, the activity area, and the termination area. Figure 6C-1 illustrates these four areas. These four areas are described in Sections 6C.04 through 6C.07.

Section 6C.04 Advance Warning Area

Support:

The advance warning area is the section of highway where road users are informed about the upcoming work zone or incident area.

Option:

The advance warning area may vary from a single sign or rotating/strobe lights on a vehicle to a series of signs in advance of the temporary traffic control zone activity area.

Guidance:

Typical distances for placement of advance warning signs on expressways and freeways should be longer because drivers are conditioned to uninterrupted flow. Therefore, the advance warning sign placement should extend on these facilities as far as 800 m (0.5 mi) or more.

On urban streets, the effective placement of the first warning sign in meters (feet) should range from 0.75 to 1.5 times the speed limit in km/h (4 to 8 times the speed limit in mph), with the high end of the range being used when speeds are relatively high. When a single advance warning sign is used (in cases such as low-speed residential streets), the advance warning area can be as short as 30 m (100 ft). When two or more advance warning signs are used on higher-speed streets, such as major arterials, the advance warning area should extend a greater distance (see Table 6C-1).

Since rural highways are normally characterized by higher speeds, the effective placement of the first warning sign in meters (feet) should be substantially longer – from

Figure 6C-1. Component Parts of a Temporary Traffic Control Zone

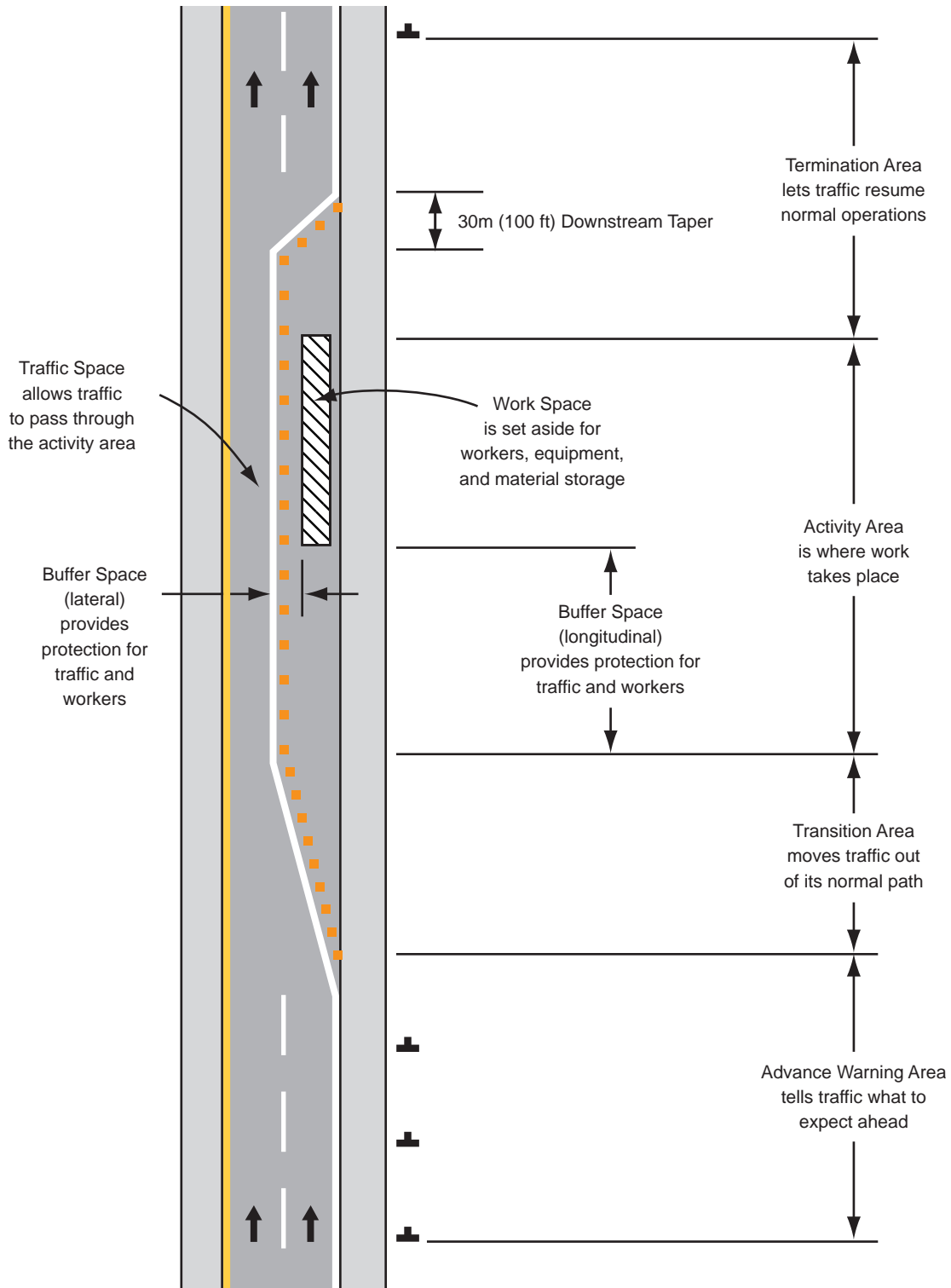

Legend

➔ Direction of travel

Table 6C-1. Suggested Advance Warning Sign Spacing

Road Type	Distance Between Signs**		
	A	B	C
Urban (low speed)*	30 (100)	30 (100)	30 (100)
Urban (high speed)*	100 (350)	100 (350)	100 (350)
Rural	150 (500)	150 (500)	150 (500)
Expressway / Freeway	300 (1,000)	450 (1,500)	800 (2,640)

* Speed category to be determined by highway agency

** Distances are shown in meters (feet). The column headings A, B, and C are the dimensions shown in Figures 6H-1 through 6H-46. The A dimension is the distance from the transition or point of restriction to the first sign. The B dimension is the distance between the first and second signs. The C dimension is the distance between the second and third signs. (The third sign is the first one in a three-sign series encountered by a driver approaching a temporary traffic control zone.)

1.5 to 2.25 times the speed limit in km/h (8 to 12 times the speed limit in mph). Since two or more advance warning signs are normally used for these conditions, the advance warning area should extend 450 m (1,500 ft) or more for open highway conditions (see Table 6C-1).

Option:

Advance warning may be eliminated when the activity area is sufficiently removed from the road users' path so that it does not interfere with the normal flow.

Section 6C.05 Transition Area

Support:

The transition area is that section of highway where road users are redirected out of their normal path.

Standard:

When redirection of the road users' normal path is required, they shall be channelized from the normal path to a new path.

Support:

In mobile operations, the transition area moves with the work space. Transition areas usually involve strategic use of tapers, which because of their importance are discussed separately in detail.

Section 6C.06 Activity Area**Support:**

The activity area is the section of the highway where the work activity takes place. It is comprised of the work space, the traffic space, and the buffer space.

The work space is that portion of the highway closed to road users and set aside for workers, equipment, and material, and a shadow vehicle if one is used upstream. Work spaces are usually delineated for road users by channelizing devices or, to exclude vehicles and pedestrians, by temporary barriers.

Option:

The work space may be stationary or may move as work progresses.

Guidance:

Since there may be several work spaces (some even separated by several kilometers or miles) within the project limits, each work space should be adequately signed to inform road users and reduce confusion.

Support:

The traffic space is the portion of the highway in which road users are routed through the activity area.

The buffer space is a lateral and/or longitudinal area that separates road user flow from the work space or an unsafe area, and might provide some recovery space for an errant vehicle.

Guidance:

Neither work activity nor storage of equipment, vehicles, or material should occur within a buffer space.

Option:

Buffer spaces may be positioned either longitudinally or laterally with respect to the direction of road user flow. The activity area may contain one or more lateral or longitudinal buffer spaces.

A longitudinal buffer space may be placed in advance of a work space.

The longitudinal buffer space may also be used to separate opposing road user flows that use portions of the same traffic lane, as shown in Figure 6C-2.

Support:

Typically, the buffer space is formed as a traffic island and defined by channelizing devices. When a formidable device, such as a shadow vehicle or an arrow panel, is placed in such an island, only the area in front of the device functions as a buffer.

Option:

The lateral buffer space may be used to separate the traffic space from the work space, as shown in Figures 6C-1 and 6C-2, or such areas as excavations or pavement-edge drop-offs. A lateral buffer space also may be used between two travel lanes, especially those carrying opposing flows.

Guidance:

The width of a lateral buffer space should be determined by engineering judgment.

Option:

When work occurs on a high-volume, highly-congested facility, an incident management vehicle storage space may be provided so that emergency vehicles (for example, tow trucks) can respond quickly to road user incidents.

Guidance:

If used, an emergency-vehicle storage area should not extend into any portion of the buffer space.

Section 6C.07 Termination Area

Support:

The termination area is used to return road users to their normal path. The termination area extends from the downstream end of the work area to the END ROAD WORK signs, if posted.

Option:

An END ROAD WORK sign, a Speed Limit sign, or other signs may be used to inform road users that they can resume normal operations.

Figure 6C-2. Types of Tapers and Buffer Spaces

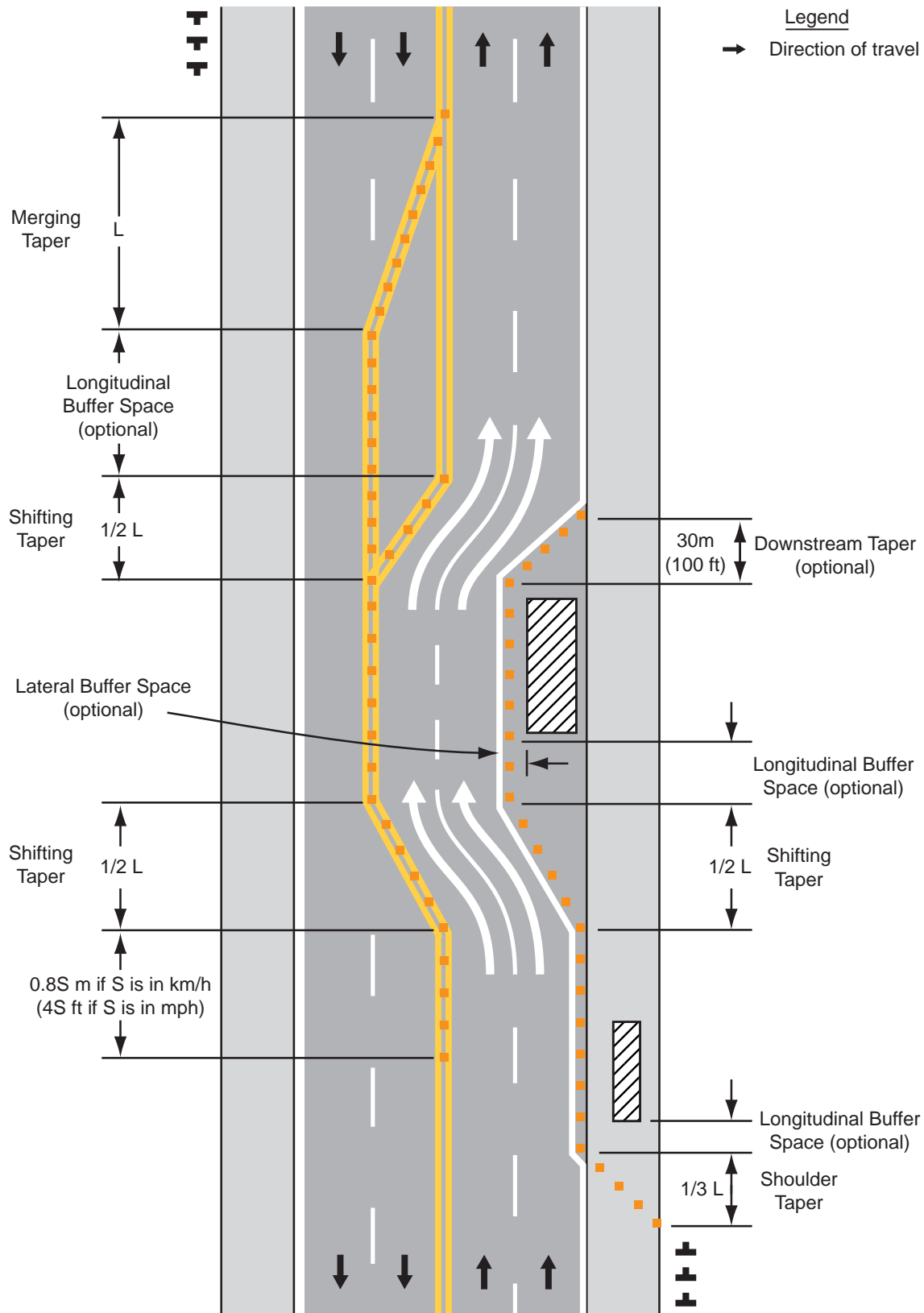

Section 6C.08 Tapers**Option:**

Tapers may be used in both the transition and termination areas. Whenever tapers are to be used in close proximity to an interchange ramp, crossroads, curves, or other influencing factors, the length of the tapers may be adjusted.

Support:

Tapers are created by using a series of channelizing devices and/or pavement markings to move traffic out of or into the normal path. Types of tapers are shown in Figure 6C-2.

Longer tapers are not necessarily better than shorter tapers (particularly in urban areas characterized by short block lengths, driveways, etc.) because extended tapers tend to encourage sluggish operation and to encourage drivers to delay lane changes unnecessarily. The test concerning adequate lengths of tapers involves observation of driver performance after temporary traffic control plans are put into effect.

Guidance:

The criteria for determining the taper length (L) is shown in Table 6C-2 and should be the minimum used.

The maximum distance in meters (feet) between devices in a taper should not exceed 0.2 times the speed limit in km/h (1.0 times the speed limit in mph).

Support:

A merging taper requires the longest distance because drivers are required to merge into common road space.

Guidance:

A merging taper should be long enough to enable merging drivers to have adequate advance warning and sufficient length to adjust their speeds and merge into a single lane before the end of the transition.

Support:

A shifting taper is used when a lateral shift is needed. When more space is available, a longer than minimum taper distance can be beneficial. Changes in alignment can also be accomplished by using horizontal curves designed for normal highway speeds.

Guidance:

A shifting taper should have a length of approximately 0.5 L (see Table 6C-2).

**Table 6C-2. Taper Length Criteria for
Temporary Traffic Control Zones**

Type of Taper	Taper Length (L)*
Merging Taper	at least L
Shifting Taper	at least 0.5L
Shoulder Taper	at least 0.33L
One-Lane, Two-Way Traffic Taper	30 m (100 ft) maximum
Downstream Taper	30 m (100 ft) per lane

* Formulas for L are as follows:

For speed limits of 60 km/h (40 mph) or less:

$$L = \frac{WS^2}{150} \quad \left(L = \frac{WS^2}{60} \right)$$

For speed limits of 70 km/h (45 mph) or greater:

$$L = \frac{WS}{1.6} \quad (L = WS)$$

Where: L = taper length in meters (feet)

W = width of offset in meters (feet)

S = posted speed limit, or off-peak

85th-percentile speed prior to work starting,
or the anticipated operating speed in km/h (mph)

Support:

A shoulder taper may be beneficial on a high-speed roadway where shoulders are part of the activity area and are closed, or when improved shoulders might be mistaken as a driving lane. In these instances, the same type, but abbreviated, closure procedures used on a normal portion in the roadway can be used.

Guidance:

If used, shoulder tapers should have a length of approximately 0.33 L (see Table 6C-2). If a shoulder is used as a travel lane, either through practice or during a temporary traffic control activity, a normal merging or shifting taper should be used.

Option:

A downstream taper may be useful in termination areas to provide a visual cue to the driver that access is available back into the original lane or path that was closed.

Guidance:

When used, a downstream taper should have a minimum length of approximately 30 m (100 ft) per lane with devices placed at a spacing of approximately 6.1 m (20 ft).

Support:

The one-lane, two-way taper is used in advance of an activity area that occupies part of a two-way roadway in such a way that a portion of the road is used alternately by traffic in each direction.

Guidance:

Traffic should be controlled by a flagger or temporary traffic signal (if sight distance is limited), or a STOP or YIELD sign. A short taper having a maximum length of 30 m (100 ft) with channelizing devices at approximately 6.1 m (20 ft) spacings should be used to guide traffic into the one-way section.

Support:

An example of a one-lane, two-way traffic taper is shown in Figure 6C-3.

Section 6C.09 Detours and Diversions**Support:**

A detour is a temporary rerouting of road users onto an existing highway in order to avoid a temporary traffic control zone.

Guidance:

Detours should be clearly signed over their entire length so that road users can easily use existing highways to return to the original highway.

Support:

A diversion is a temporary rerouting of road users onto a temporary highway or alignment placed around the work area.

Section 6C.10 One-Lane, Two-Way Traffic Control**Standard:**

When traffic in both directions must use a single lane for a limited distance, movements from each end shall be coordinated.

Figure 6C-3. Example of a One-Lane Two-Way Traffic Taper

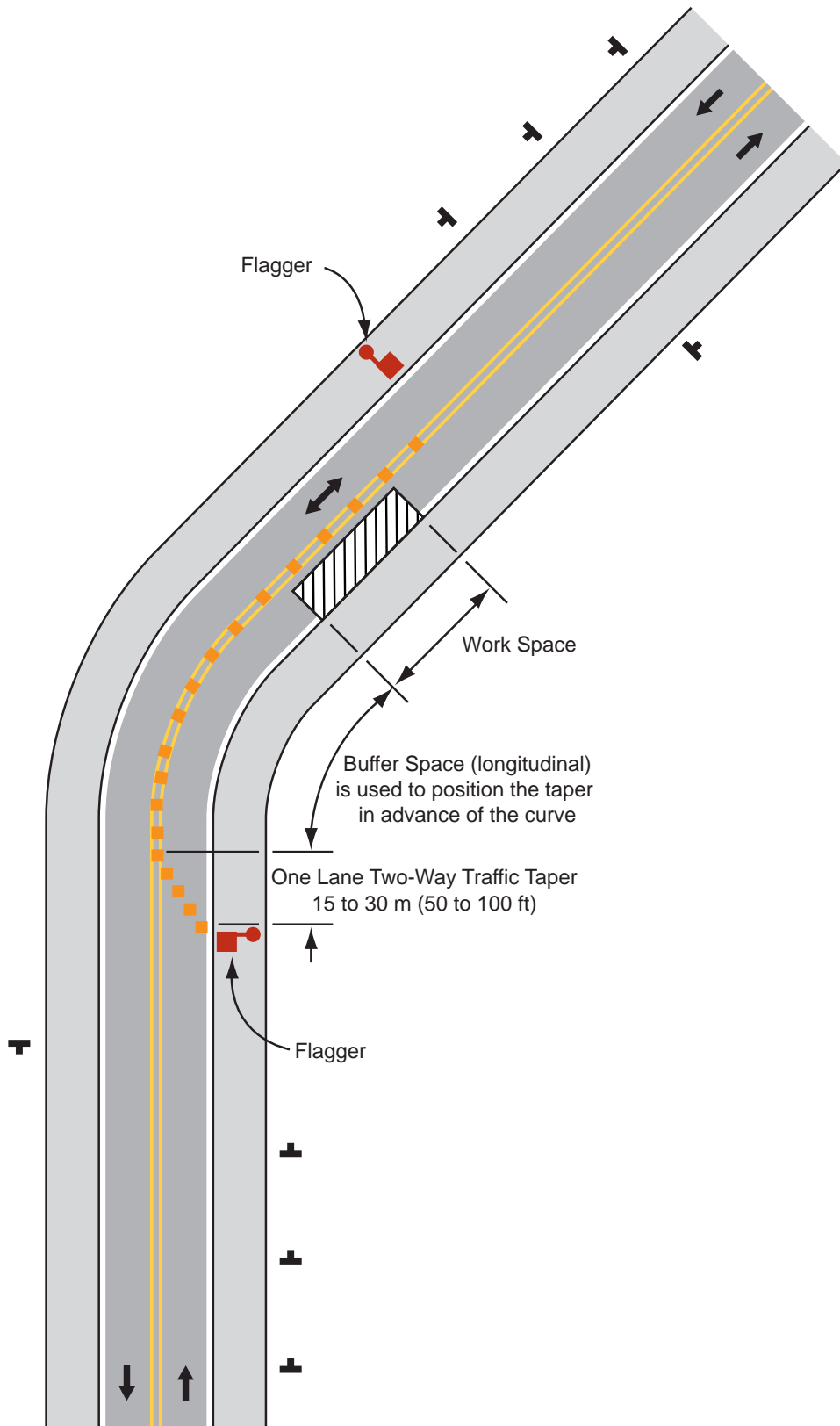

Guidance:

Provisions should be made for alternate one-way movement through the constricted section via methods such as flagger control, a flag transfer, a pilot car, traffic control signals, or stop or yield control.

Control points at each end should be chosen to permit easy passing of opposing lanes of vehicles.

If traffic on the affected one-lane roadway is not visible from one end to the other, then flagging procedures, a pilot car, or traffic signal control should be used to control opposing traffic flows.

Support:

At a spot constriction, such as an isolated pavement patch on highways with lower speeds and adequate sight distance, the movement of traffic through one-lane, two-way constrictions tends to be self-regulating.

Section 6C.11 Flagger Method of One-Lane, Two-Way Traffic Control**Option:**

When a one-lane, two-way temporary traffic control zone is short enough to allow a flagger to see from one end of the zone to the other, traffic may be controlled by either a single flagger or by a flagger at each end of the section.

Guidance:

When a single flagger is used, the flagger should be stationed on the shoulder opposite the constriction or work space, or in a position where good visibility and traffic control can be maintained at all times. When good visibility and traffic control cannot be maintained by one flagger station, traffic should be controlled by a flagger at each end of the section. One of the flaggers should be designated as the coordinator. Flaggers should be able to communicate with each other orally, electronically, or with manual signals. These manual signals should not be mistaken for flagging signals.

Section 6C.12 Flag Transfer Method of One-Lane, Two-Way Traffic Control**Support:**

The driver of the last vehicle proceeding into the one-lane section is given a red flag (or other token) and instructed to deliver it to the flagger at the other end. The opposite flagger, upon receipt of the flag, then knows that it is safe to allow traffic to move in the other direction.

A variation of this method is to replace the use of a flag with an official pilot car that always follows the last road user vehicle proceeding through the section.

Guidance:

The flag transfer method should be employed only where the one-way traffic is confined to a relatively short length of a road, usually not more than 1.6 km (1 mi) in length.

Section 6C.13 Pilot Car Method of One-Lane, Two-Way Traffic Control

Option:

A pilot car may be used to guide a queue of vehicles through the temporary traffic control zone or detour.

Guidance:

The operation of the pilot vehicle should be coordinated with flagging operations or other controls at each end of the one-lane section. The pilot car should have the name of the contractor or contracting authority prominently displayed.

Standard:

The PILOT CAR FOLLOW ME (G20-4) sign shall be mounted at a conspicuous location on the rear of the vehicle.

Section 6C.14 Temporary Traffic Control Signal Method of One-Lane, Two-Way Traffic Control

Option:

Traffic control signals may be used to control motor vehicle traffic movements in one-lane, two-way temporary traffic control zones (see Figure 6H-12 and Chapter 4G).

Section 6C.15 Stop or Yield Control Method of One-Lane, Two-Way Traffic Control

Option:

STOP or YIELD signs may be used to control traffic on low-volume roads at a one-lane, two-way work zone when drivers are able to see the other end of the one-lane, two-way operation and have sufficient visibility of approaching vehicles.

Guidance:

If the STOP or YIELD sign is installed for only one direction, then the STOP or YIELD sign should face road users who are driving on the side of the roadway that is closed for the work activity area.

CHAPTER 6D. PEDESTRIAN AND WORKER SAFETY

Section 6D.01 Pedestrian Considerations

Support:

A wide range of pedestrians can be expected at work sites, including the young, old, and disabled (for example, hearing, visual, and mobility). All of these pedestrians need a clearly delineated and usable travel path.

Standard:

The various temporary traffic control provisions for pedestrian and worker safety set forth in Part 6 shall be applied by knowledgeable (for example, trained and/or certified) persons after appropriate evaluation and engineering judgment.

Advance notification of sidewalk closures shall be provided.

Support:

It must be recognized that pedestrians are reluctant to retrace their steps to a prior intersection for a crossing.

Guidance:

Adequate provisions should be made for persons with disabilities as determined by an engineering study.

There are three considerations in planning for pedestrians in temporary traffic control zones:

- A. Pedestrians should not be led into conflicts with work site vehicles, equipment, and operations.
- B. Pedestrians should not be led into conflicts with vehicles moving through or around the work site.
- C. Pedestrians should be provided with a safe, convenient path that replicates as nearly as practical the most desirable characteristics of the existing sidewalk(s) or a footpath(s).

Consideration should be made to separate pedestrian movements from both work site activity and motor vehicle traffic. Pedestrians should be appropriately directed with advance signing that encourages them to cross to the opposite side of the roadway. In urban and suburban areas with high motor vehicle traffic volumes, these signs should be placed at intersections so that pedestrians are not confronted with mid-block work sites that will induce them to attempt skirting the work site or making a mid-block crossing.

Support:

Figures 6H-28 and 6H-29 show typical temporary traffic control device usage and techniques for pedestrian movement through work zones.

Guidance:

When pedestrian movement through or around a work site is necessary, a separate usable footpath without abrupt changes in grade or terrain should be provided.

Option:

Whenever it is feasible, closing off the work site from pedestrian intrusion may be preferable to channelizing pedestrian traffic along the site with temporary traffic control devices such as cones, tubular markers, barricades and drums, or other suitable fencing.

Guidance:

Fencing should not create sight distance restrictions for road users. Fences should not be constructed of materials that would be hazardous if impacted by vehicles.

Wooden railing, fencing, and similar systems placed immediately adjacent to motor vehicle traffic should not be used as substitutes for crashworthy temporary traffic barriers.

Standard:

Temporary traffic control devices used to delineate a temporary traffic control zone pedestrian walkway shall be crashworthy and, when struck by vehicles, present a minimum threat to pedestrians, workers, and occupants of impacting vehicles.

Guidance:

Ballast for temporary traffic control devices should be kept to the minimum amount needed and should be mounted low to prevent penetration of the vehicle windshield.

Movement by work vehicles and equipment across designated pedestrian paths should be minimized and, when necessary, should be controlled by flaggers or temporary traffic control. Staging or stopping of work vehicles or equipment along the side of pedestrian paths should be avoided, since it encourages movement of workers, equipment and materials across the pedestrian path.

Access to work space across pedestrian walkways should be minimized because the access often creates unacceptable changes in grade, and rough or muddy terrain and pedestrians will tend to avoid these areas by attempting non-intersection crossings.

Option:

A canopied walkway may be used to protect pedestrians from falling debris.

Guidance:

Covered walkways should be sturdily constructed and adequately lighted for nighttime use.

When pedestrian and vehicle paths are rerouted to a closer proximity to each other, consideration should be given to separating them by a temporary traffic barrier.

If a temporary traffic barrier is used to shield pedestrians, it should be designed to suit site conditions.

Support:

Depending on the possible motor vehicle speed and angle of impact, temporary traffic barriers might deflect upon impact by an errant vehicle. Guidance for locating and designing temporary traffic barriers can be found in Chapter 9 of AASHTO's "Roadside Design Guide" (see Section 1A.11).

Standard:

Short intermittent segments of temporary traffic barrier shall not be used because they nullify the containment and re-directive capabilities of the temporary traffic barrier, increase the potential for serious injury both to vehicle occupants and pedestrians, and encourage the presence of blunt, leading ends. All upstream leading ends that are present shall be appropriately flared or protected with properly installed and maintained crashworthy cushions. Adjacent temporary traffic barrier segments shall be properly connected in order to provide the overall strength required for the temporary traffic barrier to perform properly.

Normal vertical curbing shall not be used as a substitute for temporary traffic barriers when temporary traffic barriers are clearly needed.

Option:

Temporary traffic barriers or longitudinal channelizing devices may be used to discourage pedestrians from unauthorized movements into the work space. They may also be used to inhibit conflicts with motor vehicle traffic by minimizing the possibility of mid-block crossings.

Support:

One example of a major pedestrian concern is urban and suburban building construction encroaching onto the contiguous sidewalks, which forces pedestrians off the curb into direct conflict with moving vehicles.

Guidance:

If a high potential exists for vehicle incursions into the pedestrian path, pedestrians should be rerouted or temporary traffic barriers should be installed.

Support:

Standard temporary traffic control devices can satisfactorily delineate a pedestrian path. Although tape, rope, fencing, or plastic chain strung between devices can help discourage pedestrian movements off the designated pathway, they cannot eliminate them entirely.

Guidance:

The extent of pedestrian needs should be determined through engineering judgment for each work zone situation.

The highway agency in charge of the temporary traffic control should regularly inspect the activity area so that effective pedestrian temporary traffic control is maintained.

Section 6D.02 Worker Considerations**Support:**

Of equal importance to the safety of road users traveling through the work zone is the safety of workers. Temporary traffic control zones present temporary and constantly changing conditions that are unexpected by the road user. This creates an even higher degree of vulnerability for workers on or near the roadway.

Maintaining work zones with road user flow inhibited as little as possible, and using temporary traffic control devices that get the road user's attention and provide positive direction are of particular importance.

Guidance:

The following are the key elements of temporary traffic control management that should be considered to improve worker safety:

- A. Training - all workers should be trained on how to work next to motor vehicle traffic in a way that minimizes their vulnerability. Workers having specific temporary traffic control responsibilities should be trained in temporary traffic control techniques, device usage, and placement.
- B. Worker Clothing - workers close to the motor vehicle traveled way should wear bright, highly-visible clothing (see Section 6E.02).

- C. Temporary Traffic Barriers - temporary traffic barriers should be placed along the work space depending on factors such as lateral clearance of workers from adjacent traffic, speed of traffic, duration and type of operations, time of day, and volume of traffic.
- D. Speed Reduction - reducing the speed of motor vehicle traffic, mainly through regulatory speed zoning, funneling, use of law enforcement officials, lane reduction, or flaggers, should be considered.

Option:

The following are additional elements of temporary traffic control management that may be considered to improve worker safety:

- A. Shadow Vehicle - in the case of mobile and constantly moving operations, such as pothole patching and striping operations, a shadow vehicle, equipped with appropriate lights, warning signs, and/or a rear-mounted impact attenuator may be used to protect the workers from impacts by errant vehicles.
- B. Road Closure - if alternate routes are available to handle road users, the road may be closed temporarily. This may also facilitate project completion and thus further reduce worker vulnerability.
- C. Police Use - in highly vulnerable work situations, particularly those of relatively short duration, police units may be stationed to heighten the awareness of passing motor vehicle traffic and to improve safety through the temporary traffic control zone.
- D. Lighting - for nighttime work, the work zone and approaches may be lighted.
- E. Special Devices - judicious use of special warning and control devices may be helpful for certain difficult work zone situations. These include rumble strips, changeable message signs, hazard identification beacons, flags, and warning lights. Intrusion warning devices may be used to alert workers to the approach of errant vehicles. However, misuse or overuse of special devices or techniques may lessen their effectiveness.

CHAPTER 6E. FLAGGER CONTROL

Section 6E.01 Qualifications for Flaggers

Support:

A flagger is a person who provides temporary traffic control.

Guidance:

Because they are responsible for road user safety, and because they make frequent contact with the public, flaggers should have the following minimum qualifications:

- A. Sense of responsibility for the safety of the public and the workers
- B. Adequate training in safe temporary traffic control practices
- C. Average intelligence
- D. Good physical condition, including sight, mobility, and hearing
- E. Mental alertness and the ability to react in an emergency
- F. Courteous, but with a firm manner
- G. Neat appearance

Section 6E.02 High-Visibility Clothing

Standard:

For daytime work, the flagger's vest, shirt, or jacket shall be either orange, yellow, yellow-green, or a fluorescent version of these colors. For nighttime work, similar outside garments shall be retroreflective. The retroreflective material shall be either orange, yellow, white, silver, yellow-green, or a fluorescent version of these colors, and shall be visible at a minimum distance of 300 m (1,000 ft). The retroreflective clothing shall be designed to clearly identify the wearer as a person.

Guidance:

When uniformed law enforcement officers are used, high-visibility clothing as described above should be worn by the law enforcement officer.

Section 6E.03 Hand-Signaling Devices**Support:**

Hand-signaling devices, such as STOP/SLOW paddles, lights, and red flags, are used to control road users through temporary traffic control zones.

Guidance:

The STOP/SLOW paddle should be the primary and preferred hand-signaling device because the STOP/SLOW paddle gives road users more positive guidance than red flags. Use of flags should be limited to emergency situations.

Standard:

The STOP/SLOW paddle shall have an octagonal shape on a rigid handle. STOP/SLOW paddles shall be at least 450 mm (18 in) wide with letters at least 150 mm (6 in) high and should be fabricated from light semi-rigid material. The background of the STOP face shall be red with white letters and border. The background of the SLOW face shall be orange with black letters and border. When used at night, the STOP/SLOW paddle shall be retroreflectorized

Option:

The STOP/SLOW paddle may be modified to improve conspicuity by incorporating white flashing lights. Two lights may be installed and centered vertically above and below the STOP legend, or centered horizontally on either side of the STOP legend. Instead of the above two-light arrangement, one light may be centered below the STOP legend.

Standard:

Flags, when used, shall be a minimum of 600 mm (24 in) square, made of a good grade of red material, and securely fastened to a staff that is approximately 900 mm (36 in) in length.

Guidance:

The free edge of a flag should be weighted so the flag will hang vertically, even in heavy winds.

Standard:

When used at nighttime, flags shall be retroreflectorized red.

Section 6E.04 Flagger Procedures**Support:**

The use of paddles and flags by flaggers are illustrated in Figure 6E-1.

Standard:

The following methods of signaling with paddles shall be used:

- A. To stop road users, the flagger shall face road users and aim the STOP paddle face toward road users in a stationary position with the arm extended horizontally away from the body. The free arm shall be held with the palm of the hand above shoulder level toward approaching traffic.**
- B. To direct stopped road users to proceed, the flagger shall face road users with the SLOW paddle face aimed toward road users in a stationary position with the arm extended horizontally away from the body. The flagger shall motion with the free hand for road users to proceed.**
- C. To alert or slow traffic, the flagger shall face road users with the SLOW paddle face aimed toward road users in a stationary position with the arm extended horizontally away from the body.**

Option:

To further alert or slow traffic, the flagger holding the SLOW paddle face toward road users may motion up and down with the free hand, palm down.

Standard:

The following methods of signaling with a flag shall be used:

- A. To stop road users, the flagger shall face road users and extend the flag staff horizontally across the road users lane in a stationary position so that the full area of the flag is visibly hanging below the staff. The free arm shall be held with the palm of the hand above the shoulder level toward approaching traffic.**
- B. To direct stopped road users to proceed, the flagger shall stand parallel to the road user movement and with flag and arm lowered from the view of the road users, and shall motion with the free hand for road users to proceed. Flags shall not be used to signal road users to proceed.**

Figure 6E-1. Use of Hand-Signaling Devices by Flaggers

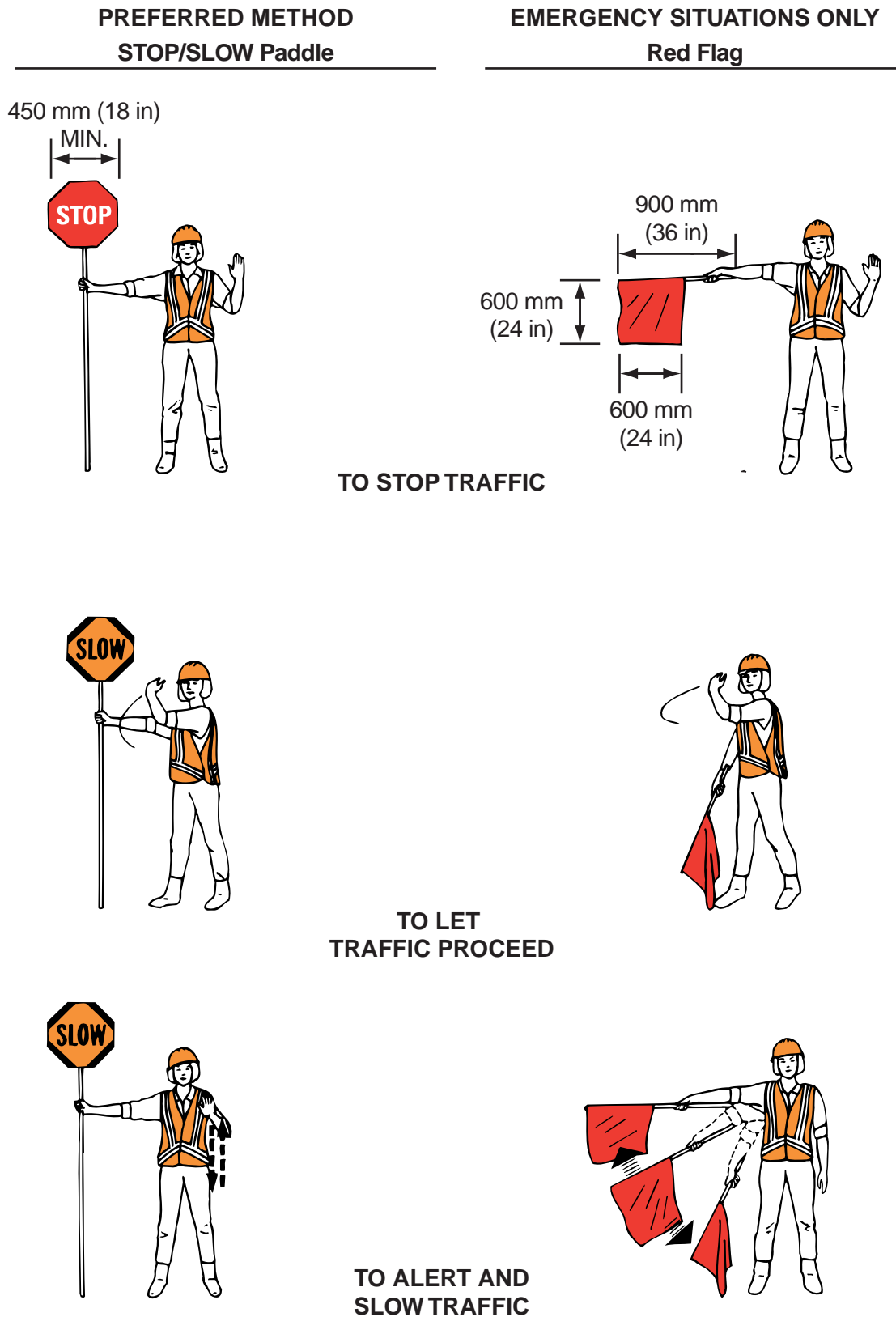

- C. To alert or slow traffic, the flagger shall face road users and slowly wave the flag in a sweeping motion of the extended arm from shoulder level to straight down without raising the arm above a horizontal position. The flagger shall keep the free hand down.**

Section 6E.05 Flagger Stations

Standard:

Flagger stations shall be located far enough in advance of the work space so that approaching road users will have sufficient distance to stop before entering the work space.

Support:

Guidelines for determining the distance of the flagger station in advance of the work space are shown in Table 6E-1.

Option:

The distances shown in Table 6E-1 may be increased for downgrades and other conditions that affect stopping distance.

Guidance:

Flagger stations should be preceded by proper advance warning signs. At night, flagger stations should be illuminated.

The flagger should stand either on the shoulder adjacent to the road user being controlled or in the closed lane prior to stopping road users. A flagger should only stand in the lane being used by moving road users after road users have stopped. The flagger should be clearly visible to first approaching road user at all times. The flagger also should be visible to other road users. The flagger should be stationed sufficiently in advance of the workers to warn them (for example, with audible warning devices such as horns, whistles, etc.) of approaching danger by out-of-control vehicles. The flagger should stand alone, never permitting a group of workers to congregate around the flagger station.

Option:

At a spot constriction, the flagger may have to take a position on the shoulder opposite the closed section in order to operate effectively.

Table 6E-1 may be used to determine the visibility distance for road users approaching the flagger.

At spot lane closures where adequate sight distance is available for the safe handling of traffic, the use of one flagger may be sufficient.

Table 6E-1. Distance of Flagger Station in Advance of the Work Space

Speed* (km/h)	Distance (m)	Speed* (mph)	Distance (ft)
30	10	20	35
40	15	25	55
50	30	30	85
60	45	35	120
70	65	40	170
80	85	45	220
90	110	50	280
100	135	55	335
110	170	60	415
120	205	65	485

* Posted speed, off-peak 85th-percentile speed prior to work starting, or the anticipated operating speed

CHAPTER 6F. TEMPORARY TRAFFIC CONTROL ZONE DEVICES

Section 6F.01 Types of Devices

Guidance:

The design and application of temporary traffic control devices used in temporary traffic control zones should consider the needs of all road users.

Support:

Crashworthiness and crash testing information on devices described in Part 6 are found in AASHTO's "Roadside Design Guide" (see Section 1A.11).

Standard:

Traffic control devices shall be defined as all signs, signals, markings, and other devices used to regulate, warn, or guide traffic, placed on, over, or adjacent to a street, highway, pedestrian facility, or bikeway by authority of a public body or official having jurisdiction.

All traffic control devices used on street and highway construction, maintenance, utility, or incident management operations shall conform to the applicable provisions of this Manual.

Option:

Where the color orange is required, fluorescent red-orange or fluorescent yellow-orange colors may also be used.

Support:

The fluorescent versions of orange provide higher conspicuity than standard orange, especially during twilight.

Section 6F.02 General Characteristics of Signs

Support:

Temporary traffic control zone signs convey both general and specific messages by means of words or symbols and have the same three categories as all road user signs: regulatory, warning, and guide.

Standard:

The colors for regulatory signs shall follow the Standards for regulatory signs in Table 2A-4 and Chapter 2B. Warning signs in temporary traffic control zones shall have a black legend on an orange background, except for the Railroad Advance Warning (W10-1) sign which shall have a black message and border on a yellow background, and except for signs that are permitted in Part 2 to have yellow or fluorescent yellow-green backgrounds. Colors for guide signs shall follow the Standards in Table 2A-4 and Chapter 2D, except for guide signs as noted in Section 6F.47.

Option:

Existing warning signs that are still applicable may remain in place.

In order to maintain the systematic use of yellow or fluorescent yellow-green background for pedestrian, bicycle, and school warning signs in a jurisdiction, the yellow or fluorescent yellow-green background for pedestrian, bicycle, and school warning signs may be used in temporary traffic control zones.

Standard orange flags or flashing warning lights may be used in conjunction with signs.

Standard:

When standard orange flags or flashing warning lights are used in conjunction with signs, they shall not block the sign face.

Option:

The dimensions of signs shown in Part 6 are for standard sizes, which may be increased wherever necessary for greater legibility or emphasis.

Standard:

Deviations from standard sizes as prescribed herein shall be in 150 mm (6 in) increments.

Support:

Sign design details are contained in the "Standard Highway Signs" book (see Section 1A.11).

Standard:

All signs used at night shall be either retroreflective with a material that has a smooth, sealed outer surface or illuminated to show the same shape and similar color both day and night.

Option:

Sign illumination may be either internal or external.

Support:

Street, highway, or strobe lighting does not constitute external sign illumination.

Option:

Signs may be made of rigid or flexible material.

Section 6F.03 Sign Placement**Guidance:**

Signs should be located on the right side of the roadway unless otherwise specified in this Manual.

Option:

Where special emphasis is needed, signs may be placed on both the left and right sides of the roadway. Signs mounted on portable supports may be placed within the roadway itself. Signs may also be mounted on or above barricades.

Support:

Guidelines for height and lateral clearance of temporary post-mounted signs are shown in Figure 6F-1.

Standard:

Post-mounted signs installed at the side of the road in rural areas shall be mounted at a height at least 1.5 m (5 ft), measured from the bottom of the sign to the near edge of the pavement. In business, commercial, and residential districts where parking and/or pedestrian movement is likely to occur, or where there are other obstructions to view, the distance between the bottom of the sign and the top of the near edge of the traveled way shall be at least 2.1 m (7 ft).

Signs mounted on barricades and barricade/sign combination shall be crashworthy.

Guidance:

Neither portable nor permanent sign supports should be located on sidewalks, bicycle lanes, or areas designated for pedestrian or bicycle traffic.

Figure 6F-1. Height and Lateral Location of Signs – Typical Installations

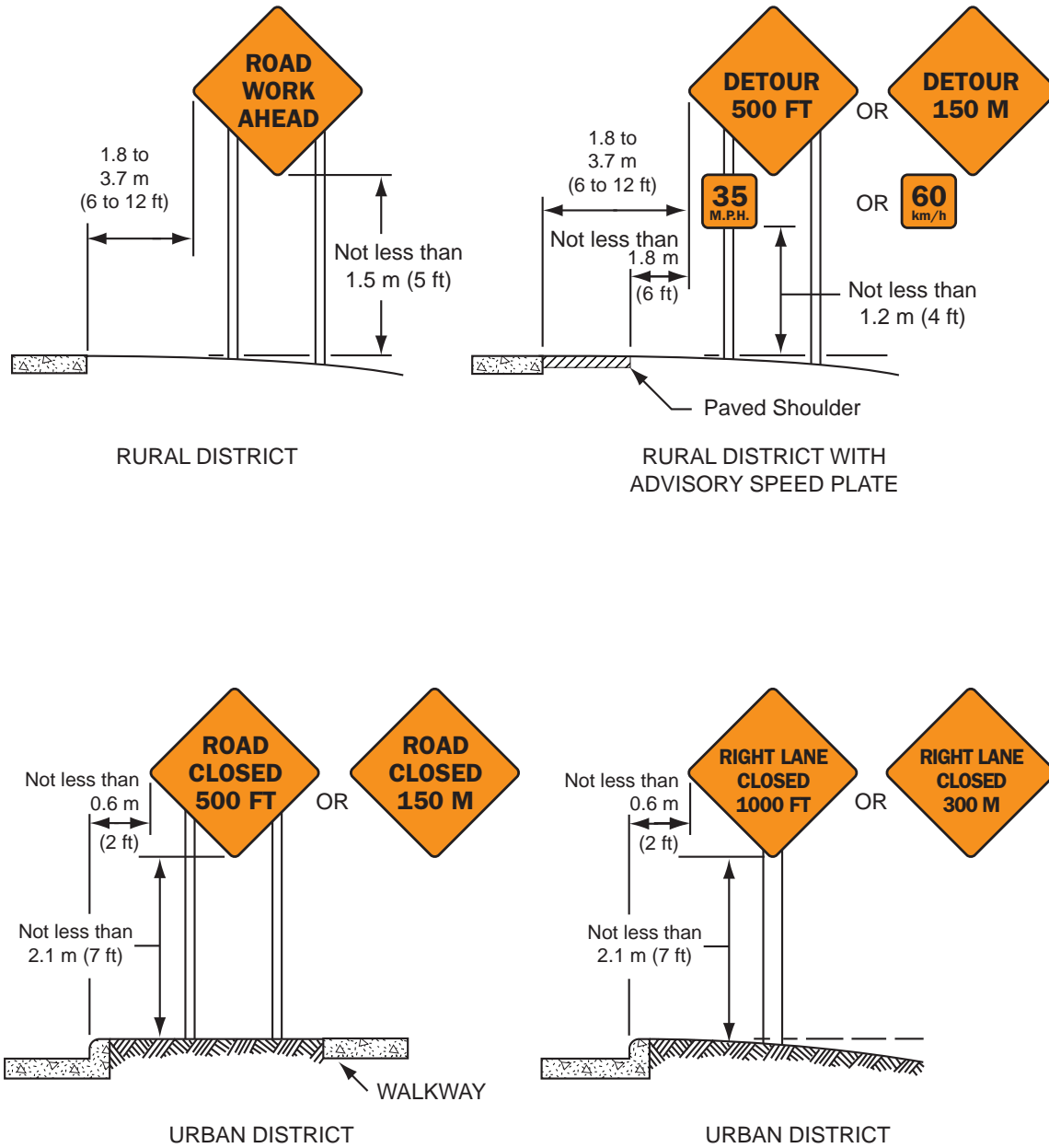

Option:

A 2.1 m (7 ft) mounting height may be used in rural areas for increased visibility.

The height to the bottom of a secondary sign mounted below another sign may be 0.3 m (1 ft) less than the appropriate height specified above.

Guidance:

Except as noted in the Option, signs mounted on portable supports should not be used for a duration of more than 3 days.

Option:

The R9-8 through R9-11a series, R11 series, W1-6 through W1-8 series, M4-10, E5-1, or other similar type signs may be used on portable supports for longer than 3 days.

Support:

Methods of mounting signs other than on posts are illustrated in Figure 6F-2.

Guidance:

Signs mounted on Type III barricades should not cover more than 50 percent of the top two rails or 33 percent of the total area of the three rails.

Standard:

Sign supports shall be crashworthy. Large signs having an area exceeding 5 square meters (50 square feet) that are installed on multiple breakaway posts shall be mounted a minimum of 2.1 m (7 ft) above the ground.

Signs mounted on barricades, or other (added by subteam to include barricade as a temporary support) portable supports, shall be no less than 0.3 m (1 ft) above the traveled way.

Option:

For mobile operations, a sign may be mounted on a work vehicle, a shadow vehicle, or a trailer stationed in advance of the temporary traffic control zone or moving along with it. The work vehicle, the shadow vehicle, or the trailer may or may not have an impact attenuator.

Figure 6F-2. Methods of Mounting Signs Other Than on Posts

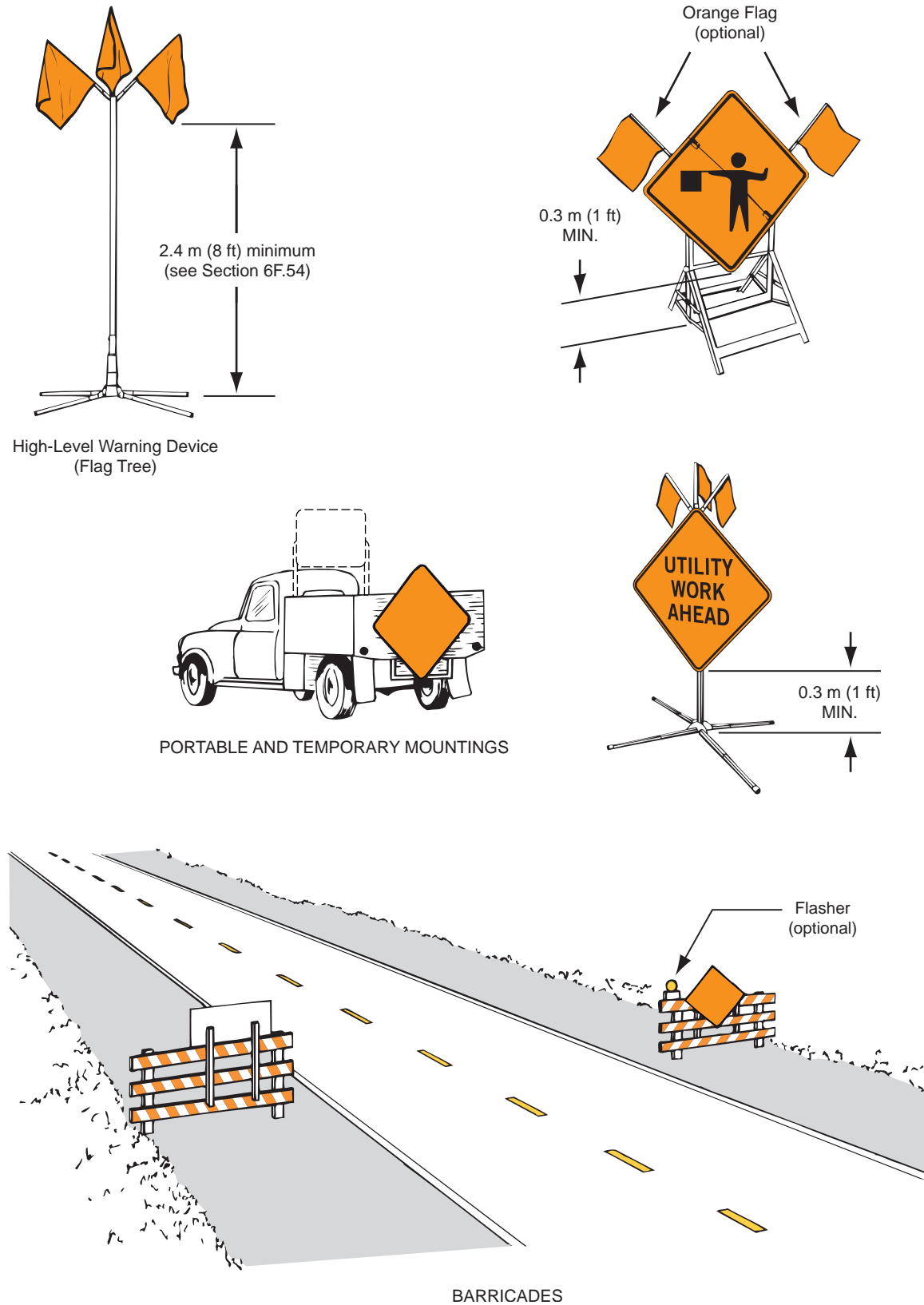

Section 6F.04 Sign Maintenance

Standard:

Signs shall be properly maintained for cleanliness, visibility, and correct positioning.

Signs that have lost significant legibility shall be promptly replaced.

Section 6F.05 Regulatory Sign Authority

Support:

Regulatory signs inform road users of traffic laws or regulations and indicate the applicability of legal requirements that would not otherwise be apparent.

Standard:

Regulatory signs shall be authorized by the public agency or official having jurisdiction and shall conform with Chapter 2B.

Section 6F.06 Regulatory Sign Design

Support:

Temporary traffic control regulatory signs shall conform to the Standards for regulatory signs presented in Part 2 and in FHWA's "Standard Highway Signs" book. Regulatory signs are generally rectangular with a black legend and border on a white background. Exceptions include the STOP, YIELD, DO NOT ENTER, WRONG WAY, and ONE WAY signs.

Option:

The ONE WAY sign may be either a horizontal or vertical rectangular sign.

Section 6F.07 Regulatory Sign Applications

Standard:

If a temporary traffic control zone requires regulatory measures different from those existing, the existing permanent regulatory devices shall be removed or covered and superseded by the appropriate temporary regulatory signs. This change shall be made in conformance with applicable ordinances or statutes of the jurisdiction.



R1-1
750 x 750 mm
(30 x 30 in)



R1-2
900 x 900 x 900 mm
(36 x 36 x 36 in)



R1-2a
1200 x 600 mm
(48 x 24 in)

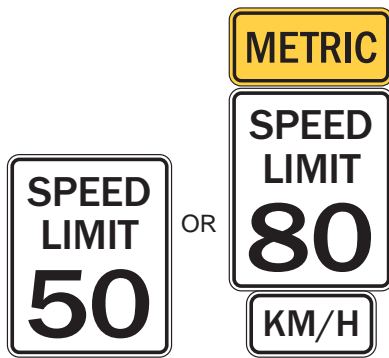

R2-1
600 x 750 mm
(24 x 30 in)

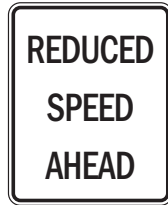

R2-5a
600 x 750 mm
(24 x 30 in)

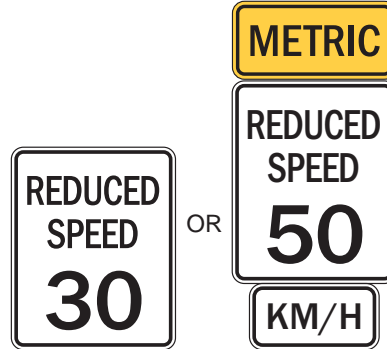

R2-5b
600 x 750 mm
(24 x 30 in)



R2-5c
600 x 750 mm
(24 x 30 in)



R3-1
600 x 600 mm
(24 x 24 in)



R3-2
600 x 600 mm
(24 x 24 in)



R3-3
600 x 600 mm
(24 x 24 in)



R3-4
600 x 600 mm
(24 x 24 in)



R3-5
750 x 900 mm
(30 x 36 in)

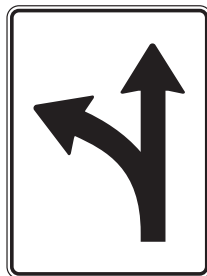

R3-6
750 x 900 mm
(30 x 36 in)



R3-7
750 x 750 mm
(30 x 30 in)

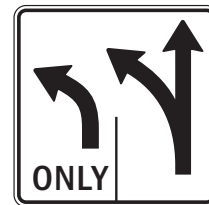

R3-8
750 x 750 mm
(30 x 30 in)



R4-1
600 x 750 mm
(24 x 30 in)



R4-2
600 x 750 mm
(24 x 30 in)

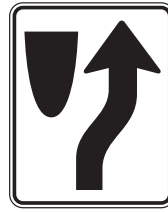

R4-7
600 x 750 mm
(24 x 30 in)



R4-9
600 x 750 mm
(24 x 30 in)



R5-1
750 x 750 mm
(30 x 30 in)



R5-1A
900 x 600 mm
(36 x 24 in)



R6-1
900 x 300 mm
(36 x 12 in)



R6-2
450 x 600 mm
(18 x 24 in)



R8-3
600 x 600 mm
(24 x 24 in)



R9-8
600 x 300 mm
(24 x 12 in)



R9-9
600 x 300 mm
(24 x 12 in)



R9-10
600 x 300 mm
(24 x 12 in)



R9-11
600 x 300 mm
(24 x 12 in)



R9-11a
600 x 300 mm
(24 x 12 in)



R11-2
1200 x 750 mm
(48 x 30 in)

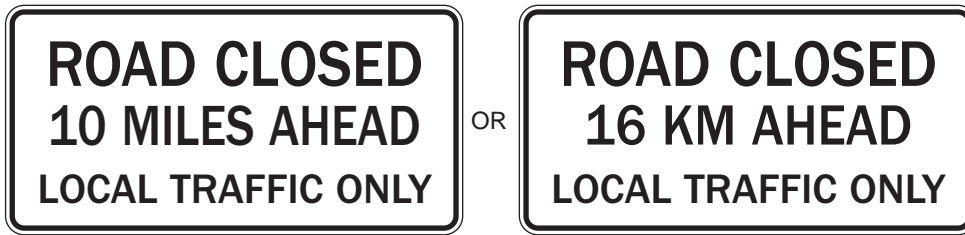

R11-3a
1500 x 750 mm
(60 x 30 in)



R11-4
1500 x 750 mm
(60 x 30 in)

R12-1
600 x 750 mm
(24 x 30 in)

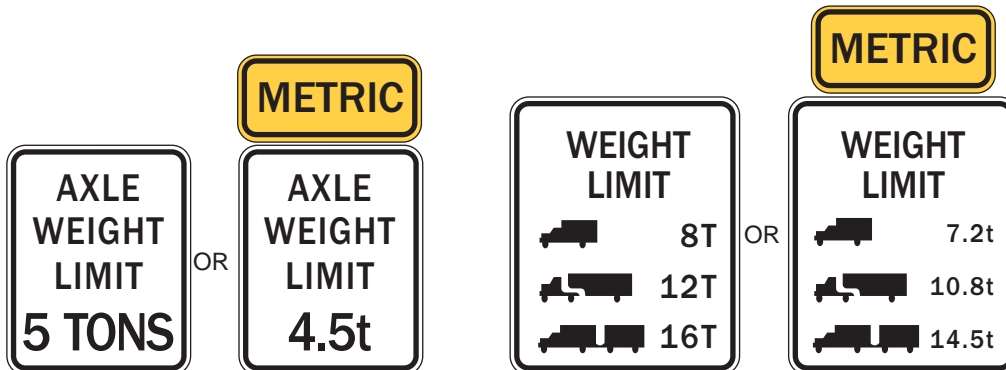

R12-2
600 x 750 mm
(24 x 30 in)

R12-5
750 x 900 mm
(30 x 36 in)

Section 6F.08 ROAD (STREET) CLOSED Sign (R11-2)**Guidance:**

The ROAD (STREET) CLOSED (R11-2) sign should be used when the roadway is closed to all road users except contractors' equipment or officially authorized vehicles. The R11-2 sign should be accompanied by appropriate warning and detour signing.

Option:

The words BRIDGE OUT (or BRIDGE CLOSED) may be substituted for ROAD (STREET) CLOSED where applicable.

Guidance:

The ROAD (STREET) CLOSED sign should be installed at or near the center of the roadway on or above a Type III barricade that closes the roadway (see Section 6F.60).

Standard:

The ROAD (STREET) CLOSED sign shall not be used where road user flow is maintained or where the actual closure is some distance beyond the sign.

Section 6F.09 Local Traffic Only Signs (R11-3a, R11-4)**Guidance:**

The Local Traffic Only signs should be used where road user flow detours to avoid a closure some distance beyond the sign, but where local road users can use the roadway to the point of closure. These signs should be accompanied by appropriate warning and detour signing.

In rural applications, the Local Traffic Only sign should have the legend ROAD CLOSED XX KM (MILES) AHEAD, LOCAL TRAFFIC ONLY (R11-3a).

Option:

In urban areas, the legend ROAD (STREET) CLOSED TO THRU TRAFFIC (R11-4) or ROAD CLOSED, LOCAL TRAFFIC ONLY may be used.

The words BRIDGE OUT (or BRIDGE CLOSED) may be substituted for the words ROAD (STREET) CLOSED on the R11-3a or R11-4 sign where applicable.

Section 6F.10 Weight Limit Signs (R12-1, R12-2, R12-5)**Standard:**

A Weight Limit sign, which shows the gross weight or axle weight that is permitted on the roadway or bridge, shall be consistent with State or local regulations and shall not be installed without the approval of the authority having jurisdiction over the highway.

When weight restrictions are imposed, a marked detour shall be provided for vehicles weighing more than the posted limit.

Section 6F.11 STAY IN LANE Sign (R4-9)**Option:**

A STAY IN LANE (R4-9) sign may be used where a multi-lane shift has been incorporated as part of the temporary traffic control on a highway to direct road users around road work that occupies part of the roadway on a multi-lane highway.

Section 6F.12 PEDESTRIAN CROSSWALK Sign (R9-8)**Option:**

The PEDESTRIAN CROSSWALK (R9-8) sign may be used to indicate where a temporary crosswalk has been established.

Section 6F.13 SIDEWALK CLOSED Signs (R9-9, R9-10, R9-11, R9-11a)**Guidance:**

SIDEWALK CLOSED signs should be used where pedestrian flow is restricted or rerouted by work activities.

The SIDEWALK CLOSED (R9-9) sign should be installed at the beginning of the closed sidewalk, at the intersections preceding the closed sidewalk, and elsewhere along the closed sidewalk as needed.

The SIDEWALK CLOSED, (ARROW) USE OTHER SIDE (R9-10) sign should be installed at the beginning of the restricted sidewalk when a parallel sidewalk exists on the other side of the roadway.

The SIDEWALK CLOSED AHEAD, (ARROW) CROSS HERE (R9-11) sign should be used to indicate to pedestrians that sidewalks beyond the sign are closed and to direct them to open crosswalks, sidewalks, or other travel paths.

The SIDEWALK CLOSED, (ARROW) CROSS HERE (R9-11a) sign should be installed just beyond the point to which pedestrians are being redirected.

Support:

These signs are typically mounted on a barricade to encourage compliance.

Section 6F.14 Special Regulatory Signs

Option:

Special regulatory signs may be used based on engineering judgment consistent with regulatory requirements.

Guidance:

Special regulatory signs should conform to the general requirements of color, shape, and alphabet size and series. The sign message should be brief, legible, and clear.

Section 6F.15 Warning Sign Function, Design, and Application

Support:

Temporary traffic control zone warning signs notify road users of specific situations or conditions on or adjacent to a roadway that might not otherwise be apparent.

Standard:

Temporary traffic control warning signs shall conform to the Standards for warning signs presented in Part 2 and in FHWA's "Standard Highway Signs" book. Except as noted in the Option below, temporary traffic control warning signs shall be diamond-shaped with a black symbol or message and border on an orange background, except for the W10-1 sign which shall have a black message and border on a yellow background, and except for signs that are permitted in Part 2 to have yellow or fluorescent yellow-green backgrounds.

Option:

Mounting or space considerations may justify a change from the standard diamond shape.

In emergencies, available warning signs having yellow backgrounds may be used if orange signs are not at hand.



W1-1
750 x 750 mm
(30 x 30 in)



W1-2
750 x 750 mm
(30 x 30 in)



W1-3
750 x 750 mm
(30 x 30 in)



W1-4
750 x 750 mm
(30 x 30 in)



W1-4b
900 x 900 mm
(36 x 36 in)



W1-4c
900 x 900 mm
(36 x 36 in)



W1-6
1200 x 600 mm
(48 x 24 in)



W1-8
450 x 600 mm
(18 x 24 in)



W3-1a
900 x 900 mm
(36 x 36 in)



W3-2a
900 x 900 mm
(36 x 36 in)



W3-3
900 x 900 mm
(36 x 36 in)



W4-1
750 x 750 mm
(30 x 30 in)



W4-1a
900 x 900 mm
(36 x 36 in)



W4-2
900 x 900 mm
(36 x 36 in)



W4-3
1200 x 1200 mm
(48 x 48 in)



W5-1
900 x 900 mm
(36 x 36 in)



W5-2
900 x 900 mm
(36 x 36 in)



W5-2a
900 x 900 mm
(36 x 36 in)



W5-3
900 x 900 mm
(36 x 36 in)



W5-4
900 x 900 mm
(36 x 36 in)



W6-1
900 x 900 mm
(36 x 36 in)



W6-2
900 x 900 mm
(36 x 36 in)



W6-3
750 x 750 mm
(30 x 30 in)



W6-4
300 x 450 mm
(12 x 18 in)



W7-1
750 x 750 mm
(30 x 30 in)



W8-1
750 x 750 mm
(30 x 30 in)



W8-2
750 x 750 mm
(30 x 30 in)



W8-3
750 x 750 mm
(30 x 30 in)



W8-4
750 x 750 mm
(30 x 30 in)



W8-5
750 x 750 mm
(30 x 30 in)



W8-6
750 x 750 mm
(30 x 30 in)



W8-7
750 x 750 mm
(30 x 30 in)



W8-8
750 x 750 mm
(30 x 30 in)



W8-9
750 x 750 mm
(30 x 30 in)



W8-9a
750 x 750 mm
(30 x 30 in)



W8-11
900 x 900 mm
(36 x 36 in)



W8-12
900 x 900 mm
(36 x 36 in)



W9-1
900 x 900 mm
(36 x 36 in)



W9-2
900 x 900 mm
(36 x 36 in)



W9-3
900 x 900 mm
(36 x 36 in)



W10-1
900 mm Diameter
(36 in)



W12-1
600 x 600 mm
(24 x 24 in)



W12-2
900 x 900 mm
(36 x 36 in)

OR



OR



W13-1
450 x 450 mm (18 x 18 in)
600 x 600 mm (24 x 24 in)



W13-4
600 x 750 mm
(24 x 30 in)



W14-3
900 x 1200 x 1200 mm
(36 x 48 x 48 in)



W20-1
1200 x 1200 mm
(48 x 48 in)

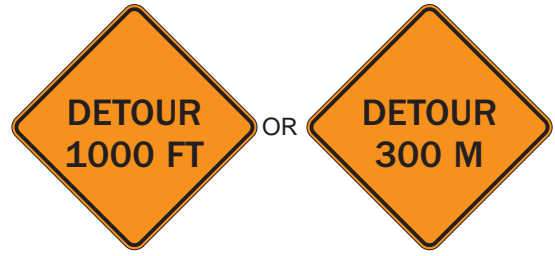

W20-2
1200 x 1200 mm
(48 x 48 in)

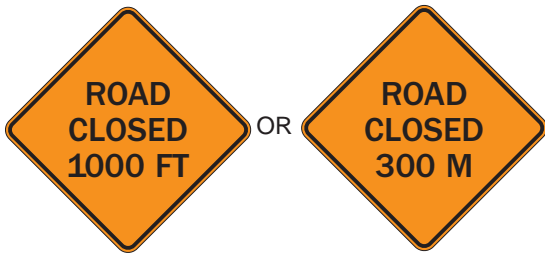

W20-3
1200 x 1200 mm
(48 x 48 in)



W20-4
1200 x 1200 mm
(48 x 48 in)



W20-5
1200 x 1200 mm
(48 x 48 in)

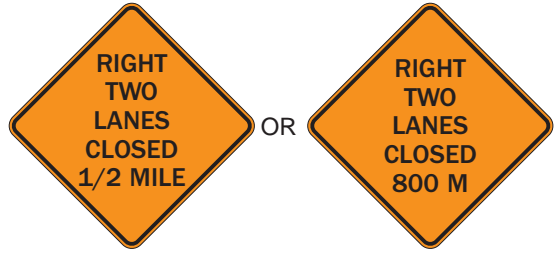

W20-5a
1200 x 1200 mm
(48 x 48 in)

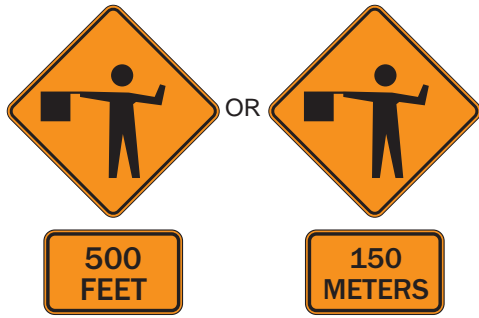

W20-7a
1200 x 1200 mm
(48 x 48 in)
SUPPLEMENTAL PLAQUE
600 x 450 mm
(24 x 18 in)



W20-7b
900 x 900 mm
(36 x 36 in)



W21-1a
900 x 900 mm
(36 x 36 in)



W21-2
750 x 750 mm
(30 x 30 in)



W21-3
900 x 900 mm
(36 x 36 in)



W21-5
750 x 750 mm
(30 x 30 in)



W21-5a
750 x 750 mm
(30 x 30 in)



W21-5b
1200 x 1200 mm
(48 x 48 in)

OR



W21-6
750 x 750 mm
(30 x 30 in)



W21-7
900 x 900 mm
(36 x 36 in)



W22-1
1200 x 1200 mm
(48 x 48 in)



W22-2
1050 x 900 mm
(42 x 36 in)



W22-3
1050 x 900 mm
(42 x 36 in)



W23-1
1200 x 600 mm
(48 x 24 in)



G20-1
900 x 450 mm
(36 x 18 in)

OR



G20-2a
900 x 450 mm
(36 x 18 in)



G20-4
900 x 450 mm
(36 x 18 in)



E5-2
1200 x 900 mm
(48 x 36 in)



E5-2a
1200 x 900 mm
(48 x 36 in)



M4-8
600 x 300 mm
(24 x 12 in)



M4-8a
600 x 450 mm
(24 x 18 in)



M4-8b
600 x 300 mm
(24 x 12 in)



M4-9
750 x 600 mm
(30 x 24 in)



M4-10
1200 x 450 mm
(48 x 18 in)

Guidance:

Where roadway or road user conditions require greater emphasis, larger than standard size warning signs should be used, with the symbol or legend enlarged approximately in proportion to the outside dimensions.

Where any part of the roadway is obstructed or closed by work activities or incidents, advance warning signs should be installed to alert road users well in advance of these obstructions or restrictions.

Option:

Advance warning signs may be used singly or in combination.

Standard:

Because of their importance, advance warning signs for higher-speed locations shall have a size of 1200 x 1200 mm (48 x 48 in) (see Part 2).

Option:

Where speeds and volumes are moderately low, a minimum size of 900 x 900 mm (36 x 36 in) may be used for advance warning signs.

On secondary roads or city streets where speeds are very low, signs smaller than the standard size, but not less than 600 x 600 mm (24 x 24 in), may be used for warning signs having short word messages or clear symbols.

Advance warning signs larger than the minimum standards may be used for additional emphasis of the temporary traffic control zone (see Part 2).

Where distances are not shown on warning signs as part of the message, a supplemental plaque with the distance legend may be mounted immediately below the sign on the same support.

Section 6F.16 Position of Advance Warning Signs**Guidance:**

Where highway conditions permit, warning signs should be placed in advance of the temporary traffic control zone at varying distances depending on roadway type, condition, and posted speed. Table 6C-1 contains information regarding the spacing of advance warning signs. Where a series of two or more advance warning signs is used, the closest sign to the temporary traffic control zone should be placed approximately 30 m (100 ft) for low-speed urban streets to 300 m (1,000 ft) or more for expressways and freeways.

Support:

Various conditions, such as limited sight distance or obstructions that might require a driver to reduce speed or stop, might require additional advance warning signs.

Option:

As an alternative to a specific distance on advance warning signs, the word AHEAD may be used.

Support:

At temporary traffic control zones on lightly-traveled roads, all of the advance warning signs prescribed for major construction might not be needed.

Option:

Utility work, maintenance, or minor construction can occur within the temporary traffic control zone limits of a major construction project, and additional warning signs may be needed.

Guidance:

Utility, maintenance, and minor construction signing and temporary traffic control should be coordinated with appropriate authorities so that road users are not confused or misled by the additional temporary traffic control devices.

Section 6F.17 ROAD (STREET) WORK Sign (W20-1)**Guidance:**

The ROAD (STREET) WORK (W20-1) sign, which serves as a general warning of obstructions or restrictions, should be located in advance of the work space or any detour, on the road where the work is taking place, and on all intersecting roadways.

Standard:

The ROAD (STREET) WORK (W20-1) sign shall have the legend ROAD (STREET) WORK, XX M (FT), XX KM (MILES), or AHEAD.

Section 6F.18 DETOUR Sign (W20-2)**Guidance:**

The DETOUR (W20-2) sign should be used in advance of a road user detour over a different roadway or route.

Standard:

The DETOUR sign shall have the legend DETOUR, XX M (FT), XX KM (MILES), or AHEAD.

Section 6F.19 ROAD (STREET) CLOSED Sign (W20-3)

Guidance:

The ROAD (STREET) CLOSED (W20-3) sign should be used in advance of the point where a highway is closed to all road users, or to all but local road users.

Standard:

The ROAD (STREET) CLOSED sign shall have the legend ROAD (STREET) CLOSED, XX M (FT), XX KM (MILES), or AHEAD.

Section 6F.20 ONE LANE ROAD Sign (W20-4)

Standard:

The ONE LANE ROAD (W20-4) sign shall be used only in advance of that point where motor vehicle traffic in both directions must use a common single lane (see Section 6C.10). It shall have the legend ONE LANE ROAD, XX M (FT), XX KM (MILES), or AHEAD.

Section 6F.21 LANE(S) CLOSED Signs (W20-5, W20-5a)

Standard:

The LANE(S) CLOSED sign shall be used in advance of that point where one or more through lanes of a multiple-lane roadway are closed.

For a single lane closure, the LANE CLOSED (W20-5) sign shall have the legend RIGHT (LEFT) LANE CLOSED, XX M (FT), XX KM (MILES), or AHEAD. Where two adjacent lanes are closed, the sign shall have the legend RIGHT (LEFT) TWO LANES CLOSED, XX M (FT), XX KM (MILES), or AHEAD.

Section 6F.22 CENTER LANE CLOSED AHEAD Signs (W9-3, W9-3a)

Guidance:

The CENTER LANE CLOSED AHEAD (W9-3) sign should be used in advance of that point where work occupies the center lane(s) and approaching motor vehicle traffic is directed to the right or left of the work zone in the center lane.

Option:

The Center Lane Closed Ahead (W9-3a) symbol sign may be substituted for the CENTER LANE CLOSED AHEAD (W9-3) word message sign.

Section 6F.23 THRU TRAFFIC MERGE RIGHT (LEFT) Sign (W4-1a)

Guidance:

The THRU TRAFFIC MERGE RIGHT (LEFT) (W4-1a) sign should be used in advance of an intersection where one or more lane closures on the far side of a multi-lane intersection require through motor vehicle traffic on the approach to the intersection to use the right (left) lane to proceed through the intersection.

Section 6F.24 Lane Reduction Sign (W4-2)

Option:

The Lane Reduction (W4-2) symbol sign may be used to warn drivers of the reduction in the number of motor vehicle traffic lanes in the direction of travel on a multi-lane roadway.

Section 6F.25 ON RAMP Plaque (W13-4)

Guidance:

When work is being done on a ramp, but the ramp remains open, the ON RAMP (W13-4) plaque should be used to supplement the advance ROAD WORK sign.

Section 6F.26 RAMP NARROWS Sign (W5-4)

Guidance:

The RAMP NARROWS (W5-4) sign should be used in advance of the point where work on a ramp reduces the normal width of the ramp along a part or all of the ramp.

Section 6F.27 SLOW TRAFFIC AHEAD Sign (W23-1)

Option:

The SLOW TRAFFIC AHEAD (W23-1) sign may be used on a shadow vehicle, usually mounted on the rear of the most upstream shadow vehicle, along with other appropriate signs for mobile operations to warn of slow moving work vehicles. A ROAD WORK (W20-1) sign may also be used with the SLOW TRAFFIC AHEAD sign.

Section 6F.28 EXIT OPEN, EXIT CLOSED Signs (E5-2, E5-2a)

Option:

An EXIT OPEN (E5-2) or EXIT CLOSED (E5-2a) sign may be used to supplement other warning signs where work is being conducted in the vicinity of an exit ramp and where the exit maneuver for motor vehicle traffic using the ramp is different from the normal condition.

Section 6F.29 Flagger Sign (W20-7, W20-7a)

Guidance:

The Flagger (W20-7a) symbol sign should be used in advance of any point where a flagger is stationed to control road users.

Option:

A distance legend may be displayed on a supplemental plaque below the Flagger sign. The sign may be used with appropriate legends or in conjunction with other warning signs, such as the BE PREPARED TO STOP (W20-7b) sign.

The FLAGGER (W20-7) word message sign with distance legends may be substituted for the Flagger (W20-7a) symbol sign.

Standard:

The Flagger sign shall be removed, covered, or turned away from road users when the flagging operations are not occurring.

Section 6F.30 Two-Way Traffic Sign (W6-3)

Guidance:

When one roadway of a normally divided highway is closed, with two-way motor vehicle traffic maintained on the other roadway, the Two-Way Traffic (W6-3) sign

should be used at the beginning of the two-way motor vehicle traffic section and at intervals to remind road users of opposing motor vehicle traffic.

Section 6F.31 Workers Sign (W21-1, W21-1a)

Option:

A Workers (W21-1a) symbol sign may be used to alert road users of workers in or near the roadway.

Guidance:

In the absence of other warning devices, a Workers symbol sign should be used when workers are in the roadway.

Option:

The WORKERS (W21-1) word message sign may be used as an alternate to the Workers (W21-1a) symbol sign.

Section 6F.32 FRESH OIL (TAR) Sign (W21-2)

Guidance:

The FRESH OIL (TAR) (W21-2) sign should be used to warn road users of the surface treatment.

Section 6F.33 ROAD MACHINERY AHEAD Sign (W21-3)

Option:

The ROAD MACHINERY AHEAD (W21-3) sign may be used to warn of machinery operating in or adjacent to the roadway.

Section 6F.34 SHOULDER WORK Signs (W21-5, W21-5a, W21-5b)

Support:

Shoulder Work signs warn of maintenance, reconstruction, or utility operations on the highway shoulder where the roadway is unobstructed.

Standard:

The Shoulder Work sign shall have the legend SHOULDER WORK (W21-5), RIGHT (LEFT) SHOULDER CLOSED (W21-5a), or RIGHT (LEFT) SHOULDER CLOSED XXX M (FT) (W21-5b).

Option:

The Shoulder Work sign may be used in advance of the point on a non-limited access highway where there is shoulder work. It may be used singly or in combination with a ROAD WORK NEXT X KM (MILES) or ROAD WORK AHEAD sign.

Guidance:

On expressways and freeways, the RIGHT (LEFT) SHOULDER CLOSED XXX M (FT) sign followed by RIGHT (LEFT) SHOULDER CLOSED sign should be used in advance of the point where the shoulder work occurs and should be preceded by a ROAD WORK AHEAD sign.

Section 6F.35 SURVEY CREW Sign (W21-6)**Guidance:**

The SURVEY CREW (W21-6) sign should be used to warn of surveying crews working in or adjacent to the roadway.

Section 6F.36 UTILITY WORK Sign (W21-7)**Option:**

The UTILITY WORK (W21-7) sign may be used as an alternate to the ROAD (STREET) WORK (W20-1) sign for utility operations on or adjacent to a highway.

Support:

Typical examples of where the UTILITY WORK sign is used appear in Figures 6H-4, 6H-6, 6H-10, 6H-15, 6H-18, 6H-21, 6H-22, 6H-26, and 6H-33.

Standard:

The UTILITY WORK sign shall carry the legend UTILITY WORK, XX M (FT), XX KM (MILES), or AHEAD.

Section 6F.37 Signs for Blasting Areas**Support:**

Radio-Frequency (RF) energy can cause the premature firing of electric detonators (blasting caps) used in work zones.

Standard:

Road users shall be warned to turn off mobile radio transmitters and cellular telephones where blasting operations occur. A sequence of signs shall be prominently displayed to direct operators of mobile radio equipment, including cellular telephones, to turn off transmitters in a blasting area. These signs shall be covered or removed when there are no explosives in the area or the area is otherwise secured.

Guidance:

A minimum safe distance of 300 m (1,000 ft) should be used for warning sign placement.

Section 6F.38 BLASTING ZONE AHEAD Sign (W22-1)**Standard:**

The BLASTING ZONE AHEAD (W22-1) sign shall be used in advance of any temporary traffic control zone where explosives are being used. The TURN OFF 2-WAY RADIO AND PHONE and END BLASTING ZONE signs shall be used in sequence with this sign.

Section 6F.39 TURN OFF 2-WAY RADIO AND PHONE Sign (W22-2)**Standard:**

The TURN OFF 2-WAY RADIO AND PHONE (W22-2) sign shall follow the BLASTING ZONE AHEAD sign and shall be placed at least 300 m (1,000 ft) before the beginning of the blasting zone.

Section 6F.40 END BLASTING ZONE Sign (W22-3)

Standard:

The END BLASTING ZONE (W22-3) sign shall be placed a minimum of 300 m (1,000 ft) past the blasting zone.

Option:

The END BLASTING ZONE sign may be placed either with or preceding the END ROAD WORK sign.

Section 6F.41 SHOULDER DROP-OFF Sign (W8-9a)

Standard:

The SHOULDER DROP-OFF (W8-9a) sign shall be used when a shoulder drop-off, adjacent to the travel lane, exceeds 75 mm (3 in) in depth and is not protected by portable barriers.

Section 6F.42 UNEVEN LANES Sign (W8-11)

Guidance:

The UNEVEN LANES (W8-11) sign should be used during operations that create a difference in elevation between adjacent lanes.

Section 6F.43 NO CENTER STRIPE Sign (W8-12)

Guidance:

The NO CENTER STRIPE (W8-12) sign should be used when the work obliterates the centerline pavement markings. This sign should be placed at the beginning of the temporary traffic control zone and repeated at 3.2 km (2 mi) intervals in long temporary traffic control zones.

Section 6F.44 Other Warning Signs

Option:

Advance warning signs may be used by themselves or with other advance warning signs.

Besides the warning signs specifically related to temporary traffic control zones, several other warning signs in Part 2 may apply in temporary traffic control zones.

Standard:

When used in temporary traffic control zones, these other warning signs shall have black legends and borders on an orange background, except for the Railroad Advance Warning (W10-1) sign, and school, pedestrian, and bicycle signs (see Section 6F.02).

Section 6F.45 Advisory Speed Plaque (W13-1)

Option:

In combination with a warning sign, an Advisory Speed (W13-1) plaque may be used to indicate a recommended safe speed through the temporary traffic control zone.

Standard:

The Advisory Speed plaque shall not be used in conjunction with any sign other than a warning sign, nor shall it be used alone. When used with orange temporary traffic control zone signs, this plaque shall have a black legend and border on an orange background. The sign shall be at least 600 x 600 mm (24 x 24 in) in size when used with a sign that is 900 x 900 mm (36 x 36 in) or larger. Except in emergencies, an Advisory Speed plaque shall not be mounted until the recommended speed is determined by the highway agency.

Section 6F.46 Supplementary Distance Plaque (W7-3a)

Option:

In combination with a warning sign, a Supplementary Distance (W7-3a) plaque with the legend NEXT XX KM (MILE) may be used to indicate the length of highway over which a work activity is being conducted, or over which a condition exists in the temporary traffic control zone.

In long temporary traffic control zones, Supplementary Distance plaques with the legend NEXT XX KM (MILES) may be placed in combination with warning signs at regular intervals within the zone to indicate the remaining length of highway over which the temporary traffic control work activity or condition exists.

Standard:

The Supplementary Distance plaque with the legend NEXT XX KM (MILES) shall not be used in conjunction with any sign other than a warning sign, nor shall it be used alone. When used with orange temporary traffic control zone signs, this plaque shall have a black legend and border on an orange background. The sign shall be at least 750 x 600 mm (30 x 24 in) in size when used with a sign that is 900 x 900 mm (36 x 36 in) or larger.

Guidance:

When used in temporary traffic control zones, the Supplementary Distance plaque with the legend NEXT XX KM (MILES) should be placed below the initial warning sign designating that, within the approaching zone, a temporary work activity or condition exists.

Section 6F.47 Guide Signs

Support:

Guide signs along highways provide road users with information to help them along their way through the temporary traffic control zone. The design of guide signs is presented in Part 2.

Guidance:

The following guide signs should be used in temporary traffic control zones as needed:

- A. Standard route markings, where temporary route changes are necessary.
- B. Directional signs and street name signs.
- C. Special guide signs relating to the condition or work being done.

Standard:

If additional guide signs are used in temporary traffic control zones, they shall have a black legend on an orange background.

Option:

When directional signs and street name signs are used in conjunction with detour routing, these signs may have a black legend on an orange background.

Section 6F.48 ROAD WORK NEXT XX KM (MILES) Sign (G20-1)**Guidance:**

The ROAD WORK NEXT XX KM (MILES) (G20-1) sign should be installed in advance of temporary traffic control zones that are more than 3.2 km (2 mi) in length.

Option:

The ROAD WORK NEXT XX KM (MILES) sign may be mounted on a Type III barricade. The sign may also be used for work zones of shorter length.

Standard:

The distance shown on the ROAD WORK NEXT XX KM (MILES) sign shall be stated to the nearest whole kilometer (or mile).

Section 6F.49 END ROAD WORK Sign (G20-2a)**Guidance:**

The END ROAD WORK (G20-2a) sign should be placed about 150 m (500 ft) beyond the temporary traffic control zone.

Option:

The END ROAD WORK sign may be installed on the back of a warning sign facing the opposite direction of road users or on the back of a Type III barricade.

Section 6F.50 Detour Signs and Markers (M4-8, M4-8a, M4-8b, M4-9, and M4-10)**Standard:**

Each detour shall be adequately marked with standard temporary route markers and destination signs.

Option:

The Detour Arrow (M4-10) sign may be used where a detour route has been established.

The DETOUR (M4-8) marker may be mounted at the top of a route marker assembly to mark a temporary route that detours from a highway, bypasses a section closed by a temporary traffic control zone, and rejoins the highway beyond the temporary traffic control zone.

Guidance:

The Detour Arrow (M4-10) sign should normally be mounted just below the ROAD CLOSED (R11-2, R11-3a, or R11-4) sign. The Detour Arrow sign should include a horizontal arrow pointed to the right or left as required.

The DETOUR (M4-9) sign should be used for unnumbered highways, for emergency situations, for periods of short durations, or where, over relatively short distances, road users are guided along the detour and back to the desired highway without route markers.

A Street Name sign should be placed above, or the street name should be incorporated into, a DETOUR (M4-9) sign to indicate the name of the street being detoured.

Option:

The END DETOUR (M4-8a or M4-8b) sign may be used to indicate that the detour has ended.

Guidance:

When the END DETOUR sign is used on a numbered highway, the sign should be mounted above a marker after the end of the detour.

Section 6F.51 PILOT CAR FOLLOW ME Sign (G20-4)**Standard:**

The PILOT CAR FOLLOW ME (G20-4) sign shall be mounted in a conspicuous position on the rear of a vehicle used for guiding one-way motor vehicle traffic through or around a temporary traffic control zone. A flagger shall be stationed on the approach to the activity area to stop motor vehicle traffic until the pilot vehicle is available.

Section 6F.52 Portable Changeable Message Signs**Support:**

Portable Changeable Message signs are temporary traffic control devices with the flexibility to display a variety of messages. Each message consists of either one or two phases. Typically, a phase consists of up to three lines of eight characters per line.

Portable Changeable Message signs are used most frequently on high-density urban freeways, but have applications on all types of highways where highway alignment, road user routing problems, or other pertinent conditions require advance warning and information.

Guidance:

The components of a Portable Changeable Message sign should include: a message sign panel, control systems, a power source, and mounting and transporting equipment.

Portable Changeable Message signs should subscribe to the principles established in this Manual and, to the extent practical, with the design (that is, color, letter size and shape, and borders) and applications prescribed in this Manual, except that the reverse colors for the letters and the background are considered acceptable.

The front face of the sign should be covered with a protective material. The color of the elements should be yellow or orange on a black background.

Portable Changeable Message signs should be visible from 0.8 km (0.5 mi) under both day and night conditions. The message should be legible from a minimum distance of 200 m (650 ft). The message panel should have adjustable display rates, so that the entire message can be read at least twice at the posted speed, the off-peak 85th-percentile speed prior to work starting, or the anticipated operating speed.

Option:

The message sign panel may vary in size.

Standard:

Portable Changeable Message signs shall automatically adjust their brightness under varying light conditions, to maintain legibility.

The control system shall include a display screen upon which messages can be reviewed before being displayed on the message sign. The control system shall be capable of maintaining memory when power is unavailable.

Portable Changeable Message signs shall be equipped with a power source and a battery back-up to provide continuous operation when failure of the primary power source occurs.

The mounting of Portable Changeable Message signs shall be such that the bottom of the message sign panel shall be a minimum of 2.1 m (7 ft) above the roadway when it is in the operating mode.

The text of the messages shall not scroll or travel horizontally or vertically across the face of the sign.

Support:

Portable Changeable Message signs have a wide variety of applications in temporary traffic control zones including: roadway, lane, or ramp closures, crash or emergency incident management, width restriction information, speed reductions, advisories on work scheduling, road user management and diversion, warning of adverse conditions, and operation control.

Guidance:

Portable Changeable Message signs should be used as a supplement to and not as a substitute for conventional signs and pavement markings.

Support:

The primary purpose of Portable Changeable Message signs in temporary traffic control zones is to advise the road user of unexpected situations. Some typical applications include the following:

- A. Where the speed of motor vehicle traffic is expected to drop substantially
- B. Where significant queuing and delays are expected
- C. Where adverse environmental conditions are present
- D. Where there are changes in alignment or surface conditions
- E. To provide advance notice of ramp, lane, or roadway closures
- F. For crash or incident management
- G. Changes in the road user pattern

Guidance:

When Portable Changeable Message signs are used for route diversion, they should be placed far enough in advance of the diversion to allow road users ample opportunity to exit the affected highway. The Portable Changeable Message signs should be sited and aligned to ensure legibility. Multiple Portable Changeable Message signs should be placed on the same side of the roadway, separated from each other at distances based on Table 6C-1.

Portable Changeable Message signs should be placed on the shoulder of the roadway or, if practical, further from the traveled lane. They should be delineated with retroreflective temporary traffic control devices or when within the clear zone, shielded with a barrier or crash cushion. When Portable Changeable Message signs are not being used, they should be removed; if not removed, they should be shielded; or if the

previous two options are not feasible, they should be delineated with retroreflective temporary traffic control devices.

Portable Changeable Message sign trailers should be delineated on a permanent basis by affixing retroreflective material, known as conspicuity material, in a continuous line on the face of the trailer as seen by oncoming road users.

Messages should be designed taking into account the following factors:

- A. Each phase should convey a single thought.
- B. If the message can be displayed in one phase, the top line should present the problem, the center line should present the location or distance ahead, and the bottom line should present the recommended driver action.
- C. The message should be as brief as possible.
- D. When a message is longer than two phases, additional Portable Changeable Message signs should be used.
- E. When abbreviations are used, they should be easily understood (see Section 1A.14).

Section 6F.53 Arrow Panels

Support:

An arrow panel is a sign with a matrix of elements capable of either flashing or sequential displays. This sign is intended to provide additional warning and directional information to assist in merging and controlling road users through or around a temporary traffic control zone.

Guidance:

An arrow panel should be used in combination with appropriate signs, channelizing devices, or other temporary traffic control devices.

An arrow panel should be placed on the shoulder of the roadway or, if practical, further from the traveled lane. It should be delineated with retroreflective temporary traffic control devices, or when within the clear zone, shielded with a barrier or crash cushion. When an arrow panel is not being used, it should be removed; if not removed, it should be shielded; or if the previous two options are not feasible, it should be delineated with retroreflective temporary traffic control devices.

Standard:

Arrow panels shall meet the minimum size, legibility distance, number of elements, and other specifications shown on Figure 6F-3.

Support:

Type A arrow panels are appropriate for use on low-speed urban streets. Type B arrow panels are appropriate for intermediate-speed facilities and for maintenance or mobile operations on high-speed roadways. Type C arrow panels are intended to be used on high-speed, high-volume motor vehicle traffic control projects. Type D arrow panels are intended for use on authorized vehicles.

Standard:

Type A, B, and C arrow panels shall have solid rectangular appearances. A Type D arrow panel shall conform to the shape of the arrow.

All arrow panels shall be finished in non-reflective black. The arrow panel shall be mounted on a vehicle, a trailer, or other suitable support.

Guidance:

The minimum mounting height of an arrow panel should be 2.1 m (7 ft) from the roadway to the bottom of the panel, except on vehicle-mounted panels, which should be as high as practical.

A vehicle-mounted arrow panel should be provided with remote controls.

Standard:

Arrow panel elements shall be capable of at least a 50 percent dimming from full brilliance. The dimmed mode shall be used for nighttime operation of arrow panels.

Guidance:

Full brilliance should be used for daytime operation of arrow panels.

Standard:

The arrow panel shall have suitable elements capable of the various operating modes. The color presented by the elements shall be yellow.

Figure 6F-3. Advance Warning Arrow Display Specifications

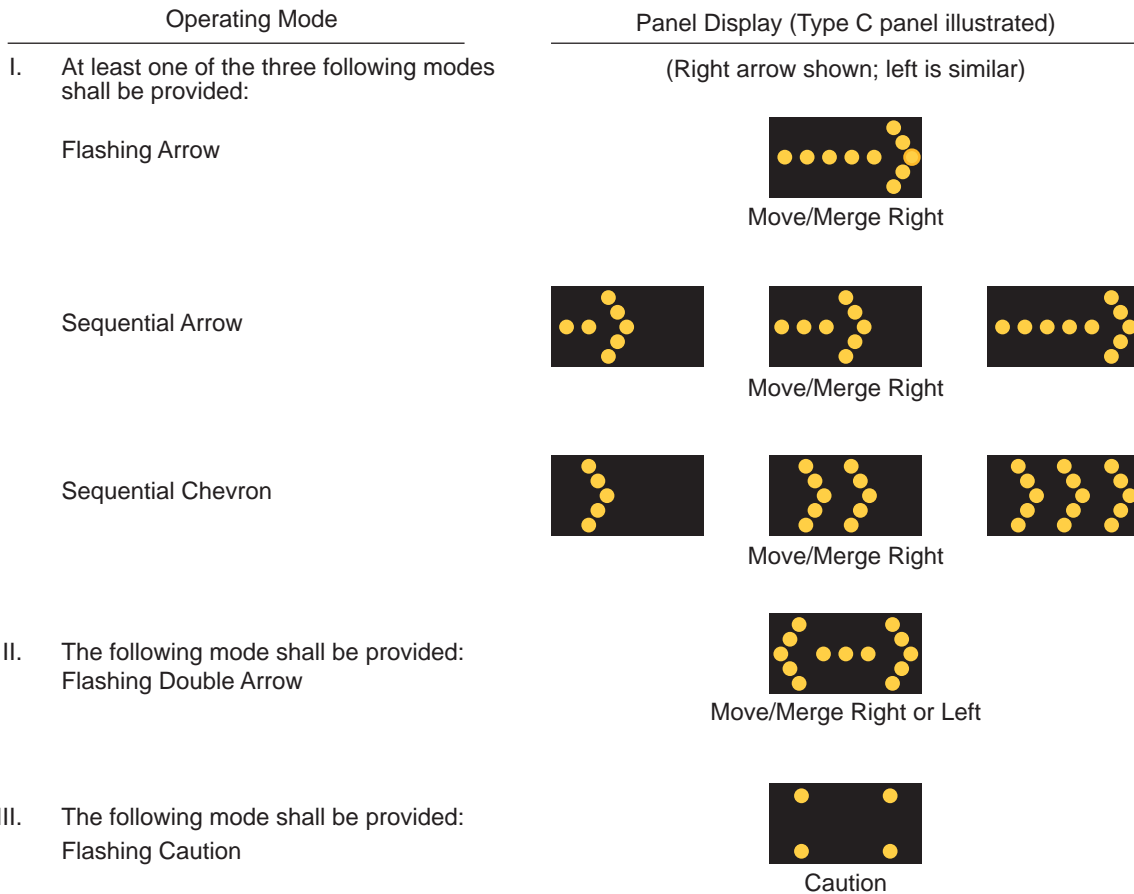

Panel Type	Minimum Size	Minimum Legibility Distance	Minimum Number of Elements
A	1,200 x 600 mm (48 x 24 in)	0.8 km (1/2 mi)	12
B	1,500 x 750 mm (60 x 30 in)	1.2 km (3/4 mi)	13
C	2,400 x 1,200 mm (96 x 48 in)	1.6 km (1 mi)	15
D	None*	0.8 km (1/2 mi)	12

*Length of arrow equals 1,200 mm (48 in), width of arrowhead equals 600 mm (24 in)

Guidance:

If an arrow panel consisting of a bulb matrix is used, the elements should be recess-mounted or equipped with an upper hood of not less than 180 degrees.

Standard:

The minimum element on-time shall be 50 percent for the flashing mode, with equal intervals of 25 percent for each sequential phase. The flashing rate shall be not less than 25 nor more than 40 flashes per minute.

An arrow panel shall have the following three mode selections:

- A. Either a Flashing Arrow, Sequential Arrow, or Sequential Chevron mode, and**
- B. A flashing Double Arrow mode, and**
- C. A flashing Caution mode.**

An arrow panel in the arrow or chevron mode shall be used only for stationary or moving lane closures on multi-lane roadways.

An arrow panel shall be used only in the caution mode for shoulder work, blocking the shoulder, for roadside work near the shoulder, or for temporarily closing one lane on a two-lane, two-way roadway.

Guidance:

For a stationary lane closure, the arrow panel should be located on the shoulder at the beginning of the shifting or merging taper.

Where the shoulder is narrow, the arrow panel should be located in the closed lane.

Standard:

When arrow panels are used to close multiple lanes, a separate arrow panel shall be used for each closed lane.

Guidance:

When arrow panels are used to close multiple lanes, if the first arrow panel is placed on the shoulder, the second arrow panel should be placed in the first closed lane at the beginning of the second merging taper (see Figure 6H-37). When the first arrow panel is

placed in the first closed lane, the second arrow panel should be placed in the second closed lane at the downstream end of the second merging taper.

For mobile operations where a lane is closed, the arrow panel should be located to provide adequate separation from the work operation to allow for appropriate reaction by approaching drivers.

Standard:

A vehicle displaying an arrow panel shall be equipped with rotating lights or strobe lights.

A single arrow panel shall not be used to shift traffic laterally more than one lane.

Section 6F.54 High-Level Warning Devices (Flag Trees)

Option:

A high-level warning device (flag tree) may supplement other temporary traffic control devices in temporary traffic control zones.

Support:

A high-level warning device is designed to be seen over the top of typical passenger cars. A typical high-level warning device is shown in Figure 6F-2.

Standard:

A high-level warning device shall consist of a minimum of two flags with or without a Type B high-intensity flashing warning light. The distance from the roadway to the bottom of the lens of the light and to the lowest point of the flag material shall be not less than 2.4 m (8 ft). The flag shall be 400 mm (16 in) square or larger and shall be orange or fluorescent red-orange in color.

Option:

An appropriate warning sign may be mounted below the flags.

Support:

High-level warning devices are most commonly used in high-density road user situations to warn road users of short-term operations.

Section 6F.55 Channelizing Devices

Support:

Designs of various channelizing devices are shown in Figure 6F-4.

The function of channelizing devices is to warn road users of conditions created by work activities in or near the roadway and to guide road users. Channelizing devices include cones, tubular markers, vertical panels, drums, barricades, and temporary raised islands.

Channelizing devices provide for smooth and gradual motor vehicle traffic flow from one lane to another, onto a bypass or detour, or into a narrower traveled way. They are also used to separate motor vehicle traffic from the work space, pavement drop-offs, pedestrian or bicycle paths, or opposing directions of motor vehicle traffic.

Guidance:

Channelizing devices should be constructed and ballasted to perform in a predictable manner when inadvertently struck by a vehicle. Channelizing devices should be crashworthy. Fragments or other debris from the device or the ballast should not pose a significant hazard to road users or workers in the immediate area.

The spacing of channelizing devices should not exceed a distance in meters (feet) equal to 0.2 times the speed limit in km/h (1.0 times the speed limit in mph) when used for taper channelization, and a distance in meters (feet) equal to 0.4 times the speed limit in km/h (2.0 times the speed limit in mph) when used for tangent channelization.

When channelizing devices have the potential of leading motor vehicle traffic out of the intended motor vehicle traffic space as shown in Figure 6H-39, the channelizing devices should be extended a distance in meters (feet) of 0.4 times the speed limit in km/h (2.0 times the speed limit in mph) beyond the end of the transition area.

Option:

Warning lights may be added to channelizing devices in areas with frequent fog, snow, or severe roadway curvature, or where visual distractions are present.

Standard:

Warning lights shall flash when placed on channelizing devices used alone or in a cluster to warn of a condition. Warning lights placed on channelizing devices used in a series to channelize road users shall be steady-burn.

The retroreflective material used on channelizing devices shall have a smooth, sealed outer surface that will display approximately the same color day or night.

Figure 6F-4. Channelizing Devices (Sheet 1 of 2)

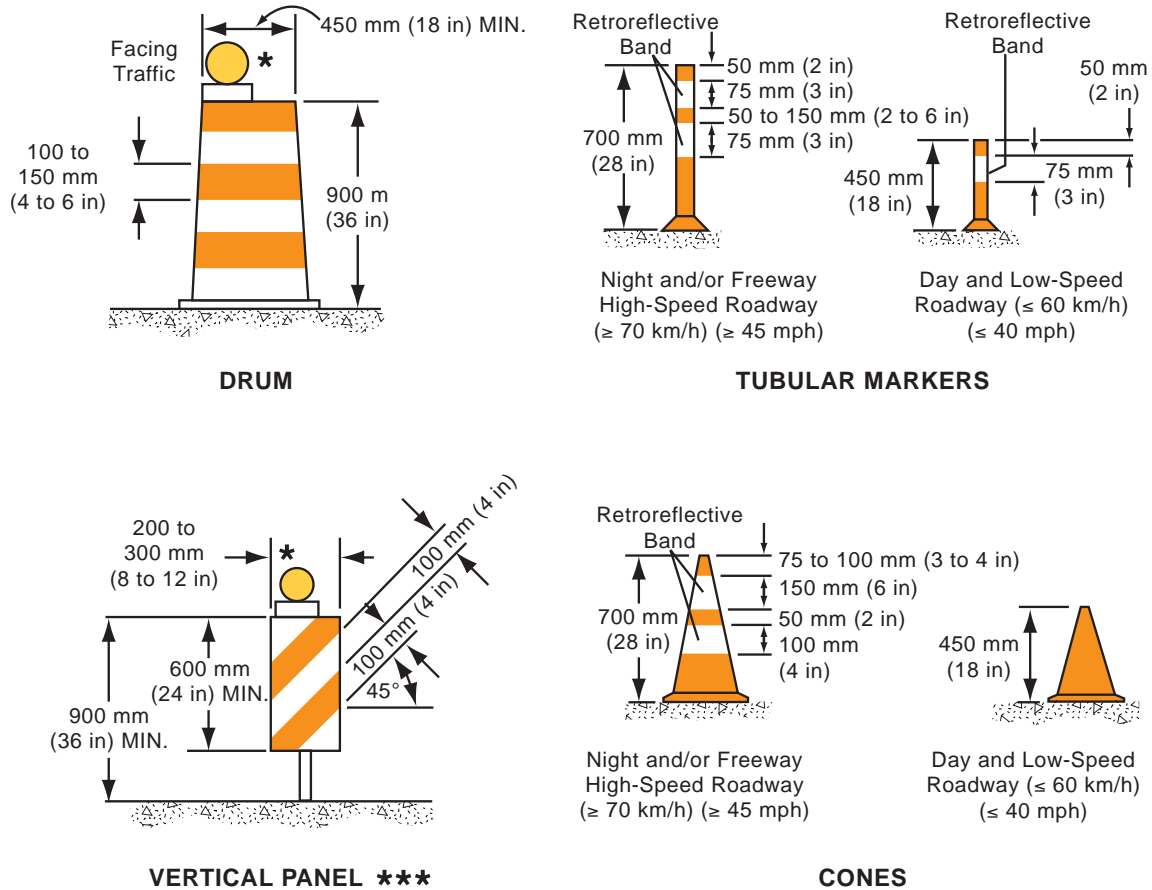

- * Warning lights (optional)
- ** Nominal lumber dimensions are satisfactory for barricade rail width dimensions.
- *** Rail stripe widths shall be 150 mm (6 in), except that 100 mm (4 in) wide stripes may be used if rail lengths are less than 900 mm (36 in).
The sides of barricades facing traffic shall have retroreflective rail faces.

Figure 6F-4. Channelizing Devices (Sheet 2 of 2)

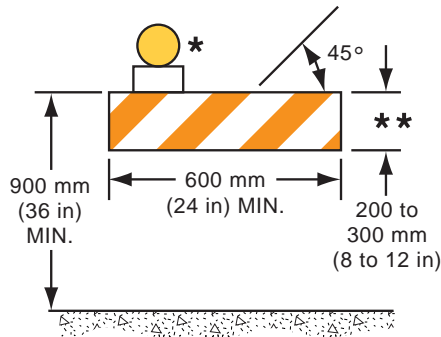

TYPE I BARRICADE ***

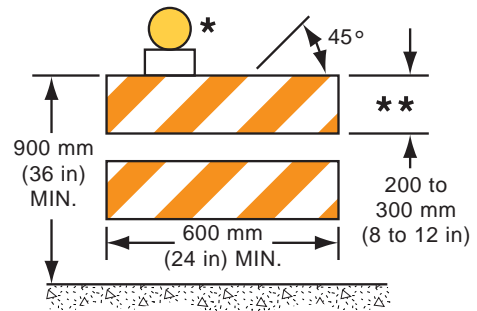

TYPE II BARRICADE ***

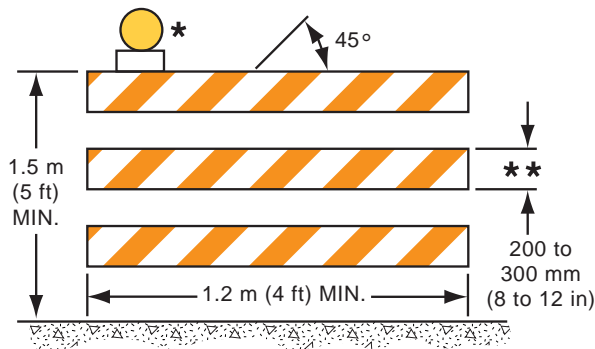

TYPE III BARRICADE ***

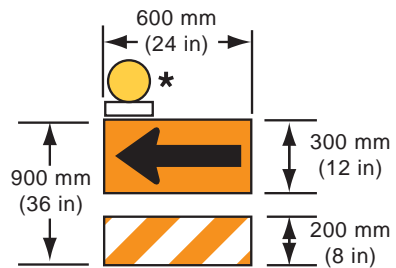

DIRECTION INDICATOR BARRICADE

- * Warning lights (optional)
- ** Nominal lumber dimensions are satisfactory for barricade rail width dimensions.
- *** Rail stripe widths shall be 150 mm (6 in), except that 100 mm (4 in) wide stripes may be used if rail lengths are less than 900 mm (36 in).
The sides of barricades facing traffic shall have retroreflective rail faces.

Option:

The name and telephone number of the highway agency, contractor, or supplier may be shown on the non-retroreflective surface of all types of channelizing devices.

Standard:

The letters and numbers of the name and telephone number shall be non-retroreflective and not over 50 mm (2 in) in height.

Guidance:

Particular attention should be given to maintaining the channelizing devices to keep them clean, visible, and properly positioned at all times.

Standard:

Devices that are damaged or have lost a significant amount of their retroreflectivity and effectiveness shall be replaced.

Section 6F.56 Cones**Standard:**

Cones (see Figure 6F-4) shall be predominantly orange and shall be made of a material that can be struck without causing damage to the impacting vehicle. For daytime and low-speed roadways, cones shall be not less than 450 mm (18 in) in height. When cones are used on freeways and other high-speed highways or at night on all highways, or when more conspicuous guidance is needed, cones shall be a minimum of 700 mm (28 in) in height.

For nighttime use, cones shall be retroreflectorized or equipped with lighting devices for maximum visibility. Retroreflectorization of 700 mm (28 in) or larger cones shall be provided by a white band 150 mm (6 in) wide located 75 to 100 mm (3 to 4 in) from the top of the cone and an additional 100 mm (4 in) wide white band approximately 50 mm (2 in) below the 150 mm (6 in) band.

Option:

Traffic cones may be used to channelize road users, divide opposing motor vehicle traffic lanes, divide lanes when two or more lanes are kept open in the same direction, and delineate short duration maintenance and utility work.

Guidance:

Steps should be taken to ensure that cones will not be blown over or displaced by wind or moving motor vehicle traffic.

Option:

Cones may be doubled up to increase their weight.

Support:

Some cones are constructed with bases that can be filled with ballast. Others have specially weighted bases, or weight such as sandbag rings that can be dropped over the cones and onto the base to provide added stability.

Guidance:

Ballast should be kept to the minimum amount needed.

Section 6F.57 Tubular Markers**Standard:**

Tubular markers (see Figure 6F-4) shall be predominantly orange, and shall be not less than 450 mm (18 in) high and 50 mm (2 in) wide facing road users. They shall be made of a material that can be struck without causing damage to the impacting vehicle.

Tubular markers shall be a minimum of 700 mm (28 in) in height when they are used on freeways and other high-speed highways, on all highways during nighttime, or whenever more conspicuous guidance is needed.

For nighttime use, tubular markers shall be retroreflectorized. Retroreflectorization of 700 mm (28 in) or larger tubular markers shall be provided by two 75 mm (3 in) wide white bands placed a maximum of 50 mm (2 in) from the top with a maximum of 150 mm (6 in) between the bands.

Guidance:

Tubular markers have less visible area than other devices and should be used only where space restrictions do not allow for the use of other more visible devices.

Tubular markers should be stabilized by affixing them to the pavement, by using weighted bases, or weights such as sandbag rings that can be dropped over the tubular

markers and onto the base to provide added stability. Ballast should be kept to the minimum amount needed.

Option:

Tubular markers may be used effectively to divide opposing lanes of road users, divide motor vehicle traffic lanes when two or more lanes are kept open in the same direction, and to delineate the edge of a pavement drop off where space limitations do not allow the use of larger devices.

Standard:

When a non-cylindrical tubular marker is used, it shall be attached to the pavement to ensure that the width facing road users meets the minimum requirements.

A tubular marker shall be attached to the pavement to display the minimum 50 mm (2 in) width to the approaching road users.

Section 6F.58 Vertical Panels

Standard:

Vertical panels (see Figure 6F-4) shall be 200 to 300 mm (8 to 12 in) in width and at least 600 mm (24 in) in height. They shall have orange and white diagonal stripes and be retroreflectorized.

Vertical panels shall be mounted with the top a minimum of 900 mm (36 in) above the roadway.

Where the height of the vertical panel itself is 900 mm (36 in) or greater, a panel stripe width of 150 (6 in) shall be used.

Option:

Where the height of the vertical panel itself is less than 900 mm (36 in), a panel stripe width of 100 mm (4 in) may be used.

Standard:

Markings for vertical panels shall be alternating orange and white retroreflective stripes, sloping downward at an angle of 45 degrees in the direction motor vehicle traffic is to pass. Vertical panels used on expressways, freeways, and other high-speed roadways shall have a minimum of 174,000 mm² (270 in²) retroreflective area facing motor vehicle traffic.

Option:

Where space is limited, vertical panels may be used to channelize motor vehicle traffic, divide opposing lanes, or replace barricades.

Section 6F.59 Drums**Standard:**

Drums (see Figure 6F-4) used for road user warning or channelization shall be constructed of lightweight, deformable materials. They shall be a minimum of 900 mm (36 in) in height and have at least a 450 mm (18 in) minimum width regardless of orientation. Metal drums shall not be used. The markings on drums shall be horizontal, circumferential, alternating orange and white retroreflective stripes 100 to 150 mm (4 to 6 in) wide. Each drum shall have a minimum of two orange and two white stripes with the top stripe being orange. Any non-retroreflectorized spaces between the horizontal orange and white stripes, shall not exceed 75 mm (3 in) wide. Drums shall have closed tops that will not allow collection of construction debris or other debris.

Support:

Drums are highly visible, have good target value, give the appearance of being formidable obstacles and, therefore, command the respect of road users. They are portable enough to be shifted from place to place within a temporary traffic control zone in order to accommodate changing conditions, but are generally used in situations where they will remain in place for a prolonged period of time.

Option:

Although drums are most commonly used to channelize or delineate road user flow, they may also be used alone or in groups to mark specific locations.

Guidance:

Drums should not be weighted with sand, water, or any material to the extent that would make them hazardous to road users or workers when struck. Drums used in regions susceptible to freezing should have drain holes in the bottom so that water will not accumulate and freeze causing a hazard if struck by a road user.

Standard:

Ballast shall not be placed on the top of a drum.

Section 6F.60 Type I, II, or III Barricades**Support:**

A barricade is a portable or fixed device having from one to three rails with appropriate markings and is used to control road users by closing, restricting, or delineating all or a portion of the right-of-way.

As shown in Figure 6F-4, barricades are classified as either Type I, Type II, or Type III.

Standard:

Stripes on barricade rails shall be alternating orange and white retroreflective stripes sloping downward at an angle of 45 degrees in the direction road users are to pass. Except as noted in the Option, the stripes shall be 150 mm (6 in) wide.

Option:

When rail lengths are less than 900 mm (36 in), 100 mm (4 in) wide stripes may be used.

Standard:

The minimum length for Type I and Type II Barricades shall be 600 mm (24 in), and the minimum length for Type III Barricades shall be 1,200 mm (48 in). Each barricade rail shall be 200 to 300 mm (8 to 12 in) wide. Barricades used on expressways, freeways and other high-speed roadways shall have a minimum of 174,000 mm² (270 in²) of retroreflective area facing road users.

Guidance:

Where barricades extend entirely across a roadway, the stripes should slope downward in the direction toward which road users must turn.

Where both right and left turns are provided, the barricade stripes should slope downward in both directions from the center of the barricade or barricades.

Where no turns are intended, the stripes should be positioned to slope downward toward the center of the barricade or barricades.

Barricade rails should be supported in a manner that will allow them to be seen by the road user, and in a manner that provides a stable support that is not easily blown over or displaced.

Option:

For Type I Barricades, the support may include other unstriped horizontal panels necessary to provide stability.

Guidance:

Barricades should be crashworthy as they are located adjacent to motor vehicle traffic flow and are subject to impact by errant vehicles.

On high-speed expressways or in other situations where barricades may be susceptible to overturning in the wind, ballasting should be used.

Option:

Sandbags may be placed on the lower parts of the frame or the stays of barricades to provide the required ballast.

Standard:

Ballast shall not be placed on top of any striped rail. Barricades shall not be ballasted by non-deformable objects such as rocks or chunks of concrete.

Support:

Type I or Type II Barricades are intended for use in situations where road user flow is maintained through the temporary traffic control zone.

Option:

Barricades may be used alone or in groups to mark a specific condition or they may be used in a series for channelizing road users.

Type I Barricades may be used on conventional roads or urban streets.

Guidance:

Type II or Type III Barricades should be used on expressways and freeways or other high-speed roadways. Type III Barricades should be used to close or partially close a road.

Option:

Type III Barricades used at a road closure may be placed completely across a roadway or from curb to curb.

Guidance:

Where provision is made for access of authorized equipment and vehicles, the responsibility for Type III Barricades should be assigned to a person to ensure proper closure at the end of each work day.

Support:

When a highway is legally closed but access must still be allowed for local road users, barricades usually are not extended completely across the roadway.

Standard:

A sign (see Section 6F.09) shall be installed with the appropriate legend concerning permissible use by local road users. Adequate visibility of the barricades from both directions shall be provided.

Option:

Signs may be installed on barricades (see Section 6F.03).

Section 6F.61 Direction Indicator Barricades**Standard:**

The Direction Indicator Barricade (see Figure 6F-4) shall consist of a retroreflective horizontal arrow top panel and a striped retroreflective bottom panel, both mounted horizontally to the ground.

The arrow panel shall be black on an orange background. The stripes on the bottom panel shall be alternating orange and white retroreflective stripes sloping downward at an angle of 45 degrees in the direction road users are to pass. The stripes shall 100 mm (4 in) wide. The arrow panel shall be 600 x 300 mm (24 x 12 in). The bottom panel shall have a length of 600 mm (24 in) and a height of 200 mm (8 in).

Guidance:

The Direction Indicator Barricade should be crashworthy.

Option:

The Direction Indicator Barricade may be used in tapers, transitions, and other areas where specific directional guidance to drivers is necessary.

Guidance:

If used, Direction Indicator Barricades should be used in series to direct the driver through the transition and into the intended travel lane.

Section 6F.62 Temporary Traffic Barriers as Channelizing Devices**Standard:**

Temporary traffic barriers shall not be used solely to channelize road users, but also to protect the work space. For nighttime use, the temporary traffic barrier shall be supplemented with delineation.

Guidance:

Temporary traffic barriers should not be used for a merging taper except in low-speed urban areas. Temporary traffic barriers should not be used for a constricted/restricted temporary traffic control zone.

When it is necessary to use a temporary traffic barrier for a merging taper in low-speed urban areas or for a constricted/restricted temporary traffic control zone, the taper shall be delineated and the taper length should be designed to optimize road user operations considering the available geometric conditions.

When used for channelization, temporary traffic barriers should be of a light color for increased visibility.

Section 6F.63 Temporary Raised Islands**Standard:**

Temporary raised islands shall be used only in combination with pavement striping and other suitable channelizing devices.

Option:

A temporary raised island may be used to separate motor vehicle traffic flows in two-lane, two-way operations on roadways having a motor vehicle traffic volume range of 4,000 to 15,000 average daily traffic (ADT) and on freeways having a motor vehicle traffic volume range of 22,000 ADT to 60,000 ADT.

Temporary raised islands also may be used in other than two-lane, two-way operations where physical separation of motor vehicle traffic from the temporary traffic control zone is not required.

Guidance:

Temporary raised islands should have the basic dimensions of 100 mm (4 in) high by 450 mm (18 in) wide and have rounded or chamfered corners.

The temporary raised islands should not be designed in such a manner that they would cause a driver to lose control of the vehicle if the vehicle inadvertently strikes the temporary raised island. If struck, pieces of the island should not be dislodged to the extent that they could penetrate the occupant compartment or involve other vehicles.

Section 6F.64 Opposing Traffic Lane Divider**Support:**

Opposing traffic lane dividers are delineation devices used as center lane dividers to separate opposing motor vehicle traffic on a two-lane, two-way operation.

Standard:

The Opposing Traffic Lane Divider (W6-4) sign is an upright, retroreflective orange-colored sign placed on a flexible support and sized at least 300 mm (12 in) wide by 450 mm (18 in) high.

Section 6F.65 Pavement Markings**Standard:**

The provisions of this Section shall not be considered applicable for short-term, mobile, or incident management temporary traffic control zones.

Pavement markings shall be maintained along paved streets and highways in all long- and intermediate-term stationary (see Section 6G.02) temporary traffic control zones. All pavement markings shall be in accordance with Chapters 3A and 3B, except as indicated in Section 6F.66. Pavement markings shall match the markings in place at both ends of the temporary traffic control zone. Pavement markings shall be placed along the entire length of any surfaced detour or temporary roadway prior to the detour or roadway being opened to road users.

Warning signs, channelizing devices, and delineation shall be used to indicate required road user paths in temporary traffic control zones where it is not possible to provide a clear path by pavement markings. All pavement markings and devices used to delineate road user paths shall be carefully reviewed during daytime and nighttime periods.

For long-term stationary operations, pavement markings in the temporary traveled way that are no longer applicable shall be removed or obliterated as soon as practical. Pavement marking obliteration shall leave a minimum of pavement scars and shall remove old marking material. Painting over existing pavement markings with black paint or spraying with asphalt shall not be accepted as a substitute for removal or obliteration.

Guidance:

Road users should be provided pavement markings within a temporary traffic control zone comparable to the pavement markings normally maintained along such roadways, particularly at either end of the temporary traffic control zone.

The intended vehicle path should be defined in day, night, and twilight periods under both wet and dry pavement conditions.

The work should be planned and staged to provide for the placement and removal of the pavement markings.

Markings should be provided in intermediate-term, stationary work zones.

Option:

Removable, nonreflective, preformed tape may be used where markings need to be covered temporarily.

Section 6F.66 Temporary Pavement Markings

Support:

Temporary pavement markings are those that are allowed to remain in place until the earliest date when it is practical and possible to install pavement markings that meet the Part 3 standards for pavement markings.

Guidance:

Temporary pavement markings should not be in place for more than 2 weeks unless justified by an engineering study.

Standard:

All temporary pavement markings, including pavement markings for no-passing zones, shall conform to the requirements of Chapters 3A and 3B. All temporary broken-line pavement markings shall use the same cycle length as permanent markings and be at least 0.6 m (2 ft) long.

Option:

Half-cycle lengths with a minimum of 0.6 m (2 ft) stripes may be used for on roadways with severe curvature (see Section 3A.06). This applies to centerlines in passing zones and lane lines.

For temporary situations of 3 calendar days or less, for a two- or three-lane road, no-passing zones may be identified by using NO PASSING ZONE (W14-3) signs (see Section 2C.32) rather than pavement markings. Also, NO PASSING ZONE signs may be used instead of pavement markings on low-volume roads (as defined in Section 5A.01) for longer periods in accordance with the State's or highway agency's policy.

Guidance:

The NO PASSING ZONE signs should be placed in accordance with Sections 2B.24, 2B.25, and 2C.32.

The temporary use of edge lines, channelizing lines, lane reduction transitions, gore markings, and other longitudinal markings, and the various non-longitudinal markings (such as stop lines, railroad crossings, crosswalks, words or symbols) should be in accordance with the State's or highway agency's policy.

Section 6F.67 Raised Pavement Markers**Standard:**

If raised pavement markers are used to substitute for broken line segments, at least two retroreflective markers shall be placed, one at each end of a segment of 0.6 m (2 ft) to 1.5 m (5 ft). For segments over 1.5 m (5 ft), a group of at least three retroreflective markers shall be equally spaced at no greater than $N/8$. The value of N for a broken or dotted line shall equal the length of one line segment plus one gap. The value of N referenced for solid lines shall equal the N for the broken or dotted lines that may be adjacent to or may extend the solid lines (see Chapter 3B).

Guidance:

Raised pavement markers should be considered for use along surfaced detours or temporary roadways, and other changed or new travel-lane alignments.

Option:

Retroreflective or internally-illuminated raised pavement markers, or non-retroreflective raised pavement markers supplemented by retroreflective or internally-illuminated markers, may replace or supplement markings prescribed in Chapters 3A and 3B.

Section 6F.68 Delineators**Standard:**

When used, delineators shall combine with or supplement other temporary traffic control devices. They shall be mounted on crashworthy supports so that the reflecting unit is approximately 1.2 m (4 ft) above the near roadway edge. The standard color for delineators used along both sides of two-way streets and highways and the right side of one-way roadways shall be white. Delineators used along the left side of one-way roadways shall be yellow.

Guidance:

Spacing along roadway curves should be as set forth in Section 3D.04 and should be such that several delineators are always visible to the driver.

Option:

Delineators may be used in temporary traffic control zones to indicate the alignment of the roadway and to outline the required vehicle path through the temporary traffic control zone.

Section 6F.69 Lighting Devices**Guidance:**

Lighting devices should be provided in temporary traffic control zones based on engineering judgment.

Support:

Four types of lighting devices are commonly used in temporary traffic control zones. They are floodlights, flashing warning beacons, warning lights, and steady-burn electric lamps.

Option:

Lighting devices may be used to supplement retroreflectorized signs, barriers, and channelizing devices.

Support:

During normal daytime maintenance operations, the functions of flashing warning beacons are adequately provided by rotating lights or strobe lights on a maintenance vehicle.

Standard:

Although vehicle hazard warning lights are permitted to be used to supplement rotating or strobe lights, they shall not be used instead of rotating or strobe lights.

Section 6F.70 Floodlights

Support:

Utility, maintenance, or construction activities on highways are frequently conducted during nighttime periods when motor vehicle traffic volumes are lower. Large construction projects are sometimes operated on a double-shift basis requiring night work.

Guidance:

When nighttime work is being performed, floodlights should be used to illuminate the work area, flagger stations, equipment crossings, and other areas.

Standard:

Floodlighting shall not produce a disabling glare condition for approaching road users.

Guidance:

The adequacy of the floodlight placement and elimination of potential glare should be determined by driving through and observing the floodlighted area from each direction on all approaching roadways after the initial floodlight setup, at night, and periodically.

Section 6F.71 Flashing Warning Beacons

Support:

Flashing warning beacons are often used to supplement a temporary control device.

Standard:

Flashing warning beacons shall comply with the provisions of Chapter 4K. A flashing warning beacon shall be a flashing yellow light with a minimum nominal diameter of 200 mm (8 in).

Guidance:

Flashing warning beacons should be operated 24 hours per day.

Support:

The temporary terminus of a freeway is an example of a location where flashing warning beacons alert drivers to the changing roadway conditions and the need to reduce speed in transitioning from the freeway to another roadway type.

Section 6F.72 Warning Lights

Standard:

Type A, Type B, and Type C warning lights are portable, powered, yellow, lens-directed, enclosed lights.

Warning lights shall be in accordance with the current ITE "Purchase Specification for Flashing and Steady-Burn Warning Lights" (see Section 1A.11).

When warning lights are used, they shall be mounted on signs or channelizing devices in a manner that, if hit by an errant vehicle, they will not be likely to penetrate the windshield.

Guidance:

The maximum spacing for warning lights should be identical to the channelizing device spacing requirements.

Support:

The light weight and portability of warning lights are advantages that make these devices useful as supplements to the retroreflectorization on signs and channelizing devices. The flashing lights are effective in attracting road users' attention.

Option:

Warning lights may be used in either a steady-burn or flashing mode.

Standard:

Flashing warning lights shall not be used for delineation, as a series of flashers fails to identify the desired vehicle path.

Type A Low-Intensity Flashing warning lights and Type C Steady-Burn warning lights shall be maintained so as to be capable of being visible on a clear night from a distance of 900 m (3,000 ft). Type B High-Intensity Flashing warning lights shall be maintained so as to be capable of being visible on a sunny day when viewed without the sun directly on or behind the device from a distance of 300 m (1,000 ft).

Warning lights shall have a minimum mounting height of 750 mm (30 in) to the bottom of the lens.

Support:

Type A Low-Intensity Flashing warning lights are used to warn road users during nighttime hours that they are approaching or proceeding in a potentially hazardous area.

Option:

Type A warning lights may be mounted on channelizing devices.

Support:

Type B High-Intensity Flashing warning lights are used to warn road users during both daylight and nighttime hours that they are approaching a potentially hazardous area.

Option:

Type B warning lights are designed to operate 24 hours per day and may be mounted on advance warning signs or on independent supports.

Type C Steady-Burn warning lights may be used during nighttime hours to delineate the edge of the traveled way.

Guidance:

When used to delineate a curve, Type C warning lights should only be used on devices on the outside of the curve, and not on the inside of the curve.

Section 6F.73 Steady-Burn Electric Lamps

Support:

Steady-Burn electric lamps are a series of low-wattage, yellow, electric lamps, generally hard-wired to a 110-volt external power source.

Option:

Steady-Burn electric lamps may be used in place of Type C Steady-Burn warning lights (see Section 6F.72).

Section 6F.74 Temporary Traffic Control Signals**Standard:**

Temporary traffic control signals (see Section 4D.20) used to control road user movements through temporary traffic control zones and in other temporary traffic control situations shall meet the applicable provisions of Part 4.

Support:

Temporary traffic control signals are typically used in work zones such as temporary haul road crossings; temporary one-way operations along a one-lane, two-way highway; temporary one-way operations on bridges, reversible lanes, and intersections.

Standard:

One-lane, two-way motor vehicle traffic flow (see Chapter 4G) requires an all-red interval of sufficient duration for road users to clear the portion of the temporary traffic control zone controlled by the traffic control signals. Safeguards shall be incorporated to avoid the possibility of conflicting signal indications at each end of the temporary traffic control zone.

Guidance:

When temporary traffic control signals are used, conflict monitors typical of traditional traffic control signal operations should be used.

Option:

Temporary traffic control signals may be portable or temporarily mounted on fixed supports.

Guidance:

Temporary traffic control signals should only be used in situations where temporary traffic control signals are preferable to other means of traffic control, such as changing the work staging or work zone size to eliminate one-way motor vehicle traffic movements, using flaggers to control one-way or crossing movements, using STOP or YIELD signs, and using warning devices alone.

Support:

Factors related to the design and application of temporary traffic control signals include the following:

- A. Safety and road user needs

- B. Work staging and operations
- C. The feasibility of using other temporary traffic control strategies (for example, flaggers, providing space for two lanes, or detouring road users)
- D. Sight distance restrictions
- E. Human factors considerations (for example, lack of driver familiarity with temporary traffic control signals)
- F. Road user volumes including roadway and intersection capacity
- G. Affected side streets and driveways
- H. Vehicle speeds
- I. The placement of other temporary traffic control devices
- J. Parking
- K. Turning restrictions
- L. Pedestrians
- M. Legal authority
- N. Signal phasing and timing requirements
- O. Full-time or part-time operation
- P. Actuated, fixed-time, or manual operation
- Q. Power failures or other emergencies
- R. Inspection and maintenance needs
- S. Need for detailed placement, timing, and operation records
- T. Operation by contractors or by others

Although temporary traffic control signals can be mounted on trailers or lightweight portable supports, fixed supports offer superior resistance to displacement or damage by severe weather, vehicle impact, and vandalism.

Guidance:

Other temporary traffic control devices should be used to supplement temporary traffic control signals, including warning and regulatory signs, pavement markings, and channelizing devices.

The design and placement of temporary traffic control signals should include interconnection to other traffic control signals along the subject roadway.

Temporary traffic control signals not in use should be covered or removed.

Section 6F.75 Temporary Traffic Barriers

Support:

Temporary traffic barriers are devices designed to help prevent penetration by vehicles while minimizing injuries to vehicle occupants, and designed to protect workers, bicyclists, and pedestrians. A typical use is where one side of a bridge is closed for deck repair. They are also used for certain special events or in other temporary traffic control contexts where separation and channelization of vehicle and pedestrian movements are needed.

Option:

Temporary traffic barriers, including shifting portable or movable barrier installations to accommodate varying directional motor vehicle traffic demands, may be used to separate two-way motor vehicle traffic.

Guidance:

Because the protective requirements of a temporary traffic control situation have priority in determining the need for temporary traffic barriers, their use should be based on an engineering study. When serving the additional function of channelizing motor vehicle traffic, temporary traffic barriers should be a light color for increased visibility.

Standard:

Temporary traffic barriers shall be supplemented with standard delineation, pavement markings, or channelizing devices for improved daytime and nighttime visibility if they are used to channelize motor vehicle traffic. The delineation or pavement marking color shall match the applicable pavement marking color.

In order to mitigate the effect of striking the end of a temporary traffic barrier, the end shall be installed in accordance with AASHTO's "Roadside Design Guide" (see Section 1A.11) by flaring until the end is outside the acceptable clear zone or by providing crashworthy end treatments.

Option:

Warning lights or steady-burn electric lamps may be mounted on temporary traffic barrier installations.

Support:

A movable barrier is a linear system of connected barrier segments that can rapidly be shifted laterally by using a specially designed transfer vehicle. The transfer is accomplished in a manner that does not interfere with motor vehicle traffic in adjacent lanes. Applications of movable barriers include the following:

- A. Closing an additional lane during work periods while maintaining the advantage of having the travel way separated from the work space by a barrier.
- B. Closing an additional lane during off-peak periods to provide extra space for work activities without adversely impacting motor vehicle traffic flow.
- C. Creating a temporary reversible lane, thus providing unbalanced capacity favoring the major direction of motor vehicle traffic flow.

More specific information on the use of temporary traffic barriers is contained in Chapters 8 and 9 of AASHTO's "Roadside Design Guide" (see Section 1A.11).

Section 6F.76 Crash Cushions

Support:

Crash cushions are systems that mitigate the effects of errant vehicles that strike obstacles, either by smoothly decelerating the vehicle to a stop when hit head-on, or by redirecting the errant vehicle. The two types of crash cushions that are used in temporary traffic control zones are stationary crash cushions and truck-mounted attenuators. Crash cushions in temporary traffic control zones help protect the drivers from the exposed ends of barriers, fixed objects, shadow vehicles, and other obstacles. Specific information on the use of crash cushions can be found in AASHTO's "Roadside Design Guide" (see Section 1A.11).

Standard:

Crash cushions shall be crashworthy. They shall also be designed for each application to stop or redirect errant vehicles under prescribed conditions. Crash cushions shall be periodically inspected to verify that they have not been hit or damaged. Damaged crash cushions shall be promptly repaired or replaced.

Support:

Stationary crash cushions are used in the same manner as permanent highway installations to protect drivers from the exposed ends of barriers, fixed objects, and other obstacles.

Standard:

Stationary crash cushions shall be designed for the specific application intended.

Support:

Truck-mounted attenuators are energy-absorbing devices attached to the rear of shadow trailers or trucks. They are located in advance of the work area, workers, or equipment to reduce the severity of rear-end crashes from errant vehicles.

Trucks or trailers are often used as shadow vehicles to protect workers or work equipment from errant vehicles. These shadow vehicles are normally equipped with flashing arrows, changeable message signs, and/or rotating/strobe lights located properly in advance of the workers and/or equipment that they are protecting. However, these shadow vehicles might themselves cause injuries to occupants of the errant vehicles if they are not equipped with truck-mounted attenuators.

Standard:

The shadow truck shall be positioned a sufficient distance in advance of the workers or equipment being protected so that there will be sufficient distance, but not so much so that errant vehicles will travel around the shadow truck and strike the protected workers and/or equipment.

Support:

Chapter 9 of AASHTO's "Roadside Design Guide" (see Section 1A.11) contains additional information regarding the use of shadow vehicles.

Guidance:

The truck-mounted attenuator should be used in accordance with the manufacturer's specifications.

Section 6F.77 Vehicle-Arresting Systems

Support:

Vehicle-arresting systems are designed to prevent penetration into activity areas while providing for smooth, safe deceleration for the errant vehicles. They can consist of portable netting, cables, and energy-absorbing anchors.

Guidance:

When used, a vehicle-arresting system should be used in accordance with the manufacturer's specifications, and should be located so that vehicles are not likely to penetrate the location that the system is designed to protect.

Section 6F.78 Rumble Strips**Support:**

Rumble strips consist of intermittent narrow, transverse areas of rough-textured or slightly raised or depressed road surface that alert drivers to unusual motor vehicle traffic conditions. Through noise and vibration they attract the driver's attention to such features as unexpected changes in alignment and to conditions requiring a stop.

Option:

Intervals between rumble strips may be reduced as the distance to the approached conditions is diminished in order to convey an impression that a closure speed is too fast and/or that an action is imminent. A sign warning drivers of the onset of rumble strips may be placed in advance of any rumble strip installation.

Guidance:

Rumble strips should be placed transverse to motor vehicle traffic movement. They should not adversely affect overall pavement skid resistance under wet or dry conditions.

In urban areas, even though a closer spacing might be warranted, care should be taken not to promote panic braking or erratic steering maneuvers by drivers.

Rumble strips should not be placed on sharp horizontal or vertical curves.

Sections 6F.79 Screens**Support:**

Screens are used to block the road users' view of activities that can be distracting. Screens might improve safety and motor vehicle traffic flow where volumes approach the roadway capacity because they discourage gawking and reduce headlight glare from oncoming motor vehicle traffic.

Guidance:

Screens should not be mounted where they could adversely restrict motorist visibility and sight distance and adversely affect the safe operation of vehicles.

Option:

Screens may be mounted on the top of temporary traffic barriers that separate two-way motor vehicle traffic.

Guidance:

Design of screens should be in accordance with Chapter 9 of AASHTO's "Roadside Design Guide" (see Section 1A.11).

Section 6F.80 Future and Experimental Devices**Support:**

The States, FHWA, AASHTO, the Transportation Research Board, and other organizations conduct research and experimentation on new traffic control and safety devices. Users of this Manual are encouraged to stay abreast of these current efforts and to use such devices with care so as to avoid presenting road users with unusual or confusing situations that might be abnormal or unexpected.

Standard:

New traffic control devices shall conform to the provisions for design, use, and application set forth in this Manual. New traffic control devices that do not conform with the provisions in this Manual shall be subject to experimentation, documentation, and adoption following the provisions of Section 1A.10.

CHAPTER 6G. TYPE OF TEMPORARY TRAFFIC CONTROL ZONE ACTIVITIES

Section 6G.01 Typical Applications

Support:

Each temporary traffic control zone is different. Many variables, such as location of work, road type, geometrics, vertical and horizontal alignment, intersections, interchanges, road user volumes, road vehicle mix (buses, trucks, and cars), and road user speeds affect the needs of each zone. The goal of temporary traffic control in work zones is safety with minimum disruption to road users. The key factor in promoting temporary traffic control zone safety is proper judgment.

Typical applications (TAs) of temporary traffic control zones are organized according to duration, location, type of work, and highway type. Table 6H-1 is an index of these typical applications. These typical applications include the use of various temporary traffic control methods, but do not include a layout for every conceivable work situation.

Guidance:

Typical applications should be altered, when necessary, to fit the conditions of a particular temporary traffic control zone.

Option:

Other devices may be added to supplement the devices shown in the typical applications, while others may be deleted. The sign spacings and taper lengths may be increased to provide additional time or space for driver response.

Support:

Decisions regarding the selection of the most appropriate typical application to use as a guide for a specific temporary traffic control zone require an understanding of each situation. Although there are many ways of categorizing work zone applications, the four factors mentioned earlier (work duration, work location, work type, and highway type) are used to characterize the typical applications illustrated in Chapter 6H.

Section 6G.02 Work Duration

Support:

Work duration is a major factor in determining the number and types of devices used in temporary traffic control zones. The duration of a temporary traffic control zone is defined relative to the length of time a work operation occupies a spot location.

Standard:

The five categories of work duration and their time at a location shall be:

- A. Long-term stationary is work that occupies a location more than 3 days.**
- B. Intermediate-term stationary is work that occupies a location more than one daylight period up to 3 days, or nighttime work lasting more than 1 hour.**
- C. Short-term stationary is daytime work that occupies a location for more than 1 hour, but less than 12 hours.**
- D. Short duration is work that occupies a location up to 1 hour.**
- E. Mobile is work that moves intermittently or continuously.**

Support:

At long-term stationary temporary traffic control zones, there is ample time to install and realize benefits from the full range of temporary traffic control procedures and devices that are available for use. Generally, larger channelizing devices, temporary roadways, and temporary traffic barriers are used.

Standard:

Since long-term operations extend into nighttime, retroreflective and/or illuminated devices shall be used in long-term stationary temporary traffic control zones.

Guidance:

Inappropriate markings in long-term stationary temporary traffic control zones should be removed and replaced with temporary markings.

Support:

In intermediate-term stationary temporary traffic control zones, it may not be feasible or practical to use procedures or devices that would be desirable for long-term stationary temporary traffic control zones, such as altered pavement markings, temporary traffic barriers, and temporary roadways. The increased time to place and remove these devices in some cases could significantly lengthen the project, thus increasing exposure time. In other instances, there might be insufficient pay-back time to economically justify more elaborate temporary traffic control measures.

Standard:

Since intermediate-term operations extend into nighttime, retroreflective and/or illuminated devices shall be used in intermediate-term stationary temporary traffic control zones.

Support:

Most maintenance and utility operations are short-term stationary work.

As compared to stationary operations, mobile and short-duration operations are activities that might involve different treatments. Devices having greater mobility might be necessary such as signs mounted on trucks. Devices that are larger, more imposing, or more visible can be used effectively and economically. The mobility of the temporary traffic control zone is important.

Maintaining safe work and road user conditions is a paramount goal in carrying out mobile operations.

Guidance:

Safety in short-duration or mobile operations should not be compromised by using fewer devices simply because the operation will frequently change its location.

Option:

Appropriately colored or marked vehicles with rotating/strobe lights, perhaps augmented with signs or arrow panels, may be used in place of signs and channelizing devices for short-duration or mobile operations.

Support:

During short-duration work, it often takes longer to set up and remove the traffic control it often takes longer to set up and remove the temporary traffic control zone than to perform the work. Workers face hazards in setting up and taking down the temporary traffic control zone. Also, since the work time is short, delays affecting road users are significantly increased when additional devices are installed and removed.

Option:

Considering these factors, simplified control procedures may be warranted for short-duration work. A reduction in the number of devices may be offset by the use of other more dominant devices such as rotating lights or strobe lights on work vehicles.

Support:

Mobile operations often involve frequent short stops for activities such as litter cleanup, pothole patching, or utility operations, and are similar to short-duration operations.

Guidance:

Warning signs, rotating/strobe lights on a vehicle, flags, and/or channelizing devices should be used and moved periodically to keep them near the mobile work area.

Option:

Flaggers may be used for mobile operations.

Support:

Mobile operations also include work activities where workers and equipment move along the road without stopping, usually at slow speeds. The advance warning area moves with the work area.

Guidance:

When mobile operations are being performed, a shadow vehicle equipped with an arrow panel or a sign should follow the work vehicle, especially when motor vehicle traffic speeds or volumes are high. Where feasible, warning signs should be placed along the roadway and moved periodically as work progresses.

Under high-volume conditions, consideration should be given to scheduling mobile operations work during off-peak hours.

If there are mobile operations on a high-speed travel lane of a multi-lane divided highway, arrow panels should be used.

Option:

For mobile operations that move at speeds less than 4 km/h (3 mph), mobile signs or stationary signing that is periodically retrieved and repositioned in the advance warning area may be used.

At higher speeds, vehicles may be used as components of the temporary traffic control zones for mobile operations. Appropriately colored and marked vehicles with signs, flags, rotating/strobe lights, truck-mounted attenuators, and arrow panels or portable changeable message signs may follow a train of moving work vehicles.

For some continuously moving operations, such as street sweeping and snow removal, a single work vehicle with appropriate warning devices on the vehicle may be used to provide warning to approaching road users.

Standard:

Mobile operations that move at speeds greater than 30 km/h (20 mph), such as pavement marking operations, shall have appropriate devices on the equipment (that is, rotating lights, signs, or special lighting), or shall use a separate vehicle with appropriate warning devices.

Section 6G.03 Location of Work

Support:

The choice of temporary traffic control needed for a temporary traffic control zone depends upon where the work is located. As a general rule, the closer the work is to road users, the greater the number of temporary traffic control devices that are needed. Procedures are described later in this Chapter for establishing temporary traffic control zones in the following locations:

- A. Outside the shoulder
- B. On the shoulder with no encroachment
- C. On the shoulder with minor encroachment
- D. Within the median
- E. Within the traveled way

Standard:

When the work space is within the traveled way, except for short-duration and mobile operations, advance warning shall provide a general message that work is taking place, shall supply information about highway conditions, and shall indicate how motor vehicle traffic can move through the temporary traffic control zone.

Section 6G.04 Modifications to Fulfill Special Needs

Support:

The typical applications in Chapter 6H illustrate commonly encountered situations in which temporary traffic control devices are employed.

Option:

Other devices may be added to supplement the devices indicated in the typical applications, and device spacing may be adjusted to provide additional reaction time. When conditions are less complex than those depicted in the typical applications, fewer devices may be needed.

Guidance:

When conditions are more complex, typical applications should be modified by incorporating appropriate devices and practices from the following list:

A. Additional devices:

1. Signs
2. Arrow panels
3. More channelizing devices at closer spacing
4. Temporary raised pavement markers
5. High-level warning devices
6. Portable changeable message signs
7. Temporary traffic signals
8. Temporary traffic barriers
9. Crash cushions
10. Screens
11. Rumble strips
12. More delineation

B. Upgrading of devices:

1. A full complement of standard pavement markings
2. Brighter and/or wider pavement markings
3. Larger and/or brighter signs
4. Channelizing devices with greater conspicuity
5. Temporary traffic barriers in place of channelizing devices

C. Improved geometrics at detours or crossovers, giving particular attention to the provisions set forth in Chapter 6B.**D. Increased distances:**

1. Longer advance warning area
2. Longer tapers

E. Lighting:

1. Temporary roadway lighting
2. Steady-burn lights used with channelizing devices
3. Flashing lights for isolated hazards
4. Illuminated signs
5. Floodlights

Support:

Uniformity of devices and their application is always of paramount importance.

As noted earlier, temporary traffic barriers are not temporary traffic control devices in themselves; however, when placed in a position identical to a line of channelizing devices and marked and/or equipped with appropriate channelization features to provide guidance and warning both day and night, they serve as temporary traffic control devices.

Standard:

Temporary traffic barriers serving as temporary traffic control devices shall conform to requirements for such devices as set forth throughout Part 6.

Section 6G.05 Work Outside of Shoulder**Support:**

When work is being performed off the roadway (beyond the shoulders, but within the right-of-way), little or no temporary traffic control may be needed. Temporary traffic control generally is not needed where work is confined to an area 4.5 m (15 ft) or more from the edge of the traveled way. However, temporary traffic control is appropriate where distracting situations exist, such as vehicles parked on the shoulder, vehicles accessing the work site via the highway, and equipment traveling on or crossing the roadway to perform the work operations (for example, mowing). For work beyond the shoulder, see Figure 6H-1.

Guidance:

Where the above situations exist, a single warning sign, such as ROAD WORK AHEAD, should be used. If the equipment travels on the roadway, the equipment should be equipped with appropriate flags, rotating/strobe lights, and/or a SLOW MOVING VEHICLE symbol.

Option:

If work vehicles are on the shoulder, a SHOULDER WORK sign may be used. For mowing operations, the sign MOWING AHEAD may be used.

Guidance:

Where the activity is spread out over a distance of more than 3.2 km (2 mi), the SHOULDER WORK sign should be repeated every 1.6 km (1 mi).

Option:

A supplementary plaque with the message NEXT X KM (MILES) may be used.

Guidance:

A general warning sign like ROAD MACHINERY AHEAD should be used if workers and equipment must occasionally move closer to the traveled way.

Section 6G.06 Work on the Shoulder with No Encroachment**Support:**

The provisions of this Section apply to short-term through long-term stationary operations.

Standard:

When paved shoulders having a width of 2.4 m (8 ft) or more are closed, at least one advance warning sign shall be used. In addition, channelizing devices shall be used to close the shoulder in advance to delineate the beginning of the work space and direct motor vehicle traffic to remain within the traveled way.

Guidance:

When a highway shoulder is occupied, a SHOULDER WORK sign, except for short duration and mobile operations, should be placed in advance of the activity area. When work is performed on a paved shoulder 2.4 m (8 ft) or more in width, channelizing devices should be placed on a taper having a length that conforms to the requirements of a shoulder taper.

When paved shoulders having a width of 2.4 m (8 ft) or more are closed on expressways and freeways, road users should be warned about potential disabled vehicles that cannot get off the traveled way. An initial general warning sign (such as ROAD WORK AHEAD) should be used, followed by a RIGHT or LEFT SHOULDER CLOSED sign. Where the end of the shoulder closure extends beyond the distance which can be perceived by road users, a supplementary plaque bearing the message NEXT X METERS (FEET) or KM (MILES) should be placed below the SHOULDER CLOSED sign. On multi-lane, divided highways, signs advising of shoulder work or the condition of the shoulder should be placed only on the side of the affected shoulder.

When an improved shoulder is closed on a high-speed roadway, it should be treated as a closure of a portion of the road system because road users expect to be able to use it in emergencies. Road users should be given ample advance warning that shoulders are closed for use as refuge areas throughout a specified length of the approaching temporary traffic control zone. The sign(s) should read SHOULDER CLOSED with distances indicated. The work space on the shoulder should be closed off by a taper or channelizing devices with a length of $0.33 L$ using the formulas in Table 6C-2.

When the shoulder is not occupied but work has adversely affected its condition, the LOW SHOULDER or SOFT SHOULDER sign should be used, as appropriate.

Where the condition extends over a distance in excess of 1.6 km (1 mi), the sign should be repeated at 1.6 km (1 mi) intervals.

Option:

In addition, a supplementary plaque bearing the message NEXT X KM (MILES) may be used. Temporary traffic barriers may be needed to inhibit encroachment of errant vehicles into the work space and to protect workers.

Standard:

When used for shoulder work, arrow panels shall operate only in the caution mode.

Support:

A typical application for stationary work operations on shoulders is shown in Figure 6H-3. Short duration or mobile work on shoulders is shown in Figure 6H-4. Work on freeway shoulders is shown in Figure 6H-5.

Section 6G.07 Work on the Shoulder with Minor Encroachment

Guidance:

When work takes up part of a lane, motor vehicle traffic volumes, vehicle mix (buses, trucks, and cars), speed, and capacity, should be analyzed to determine whether the affected lane should be closed. Unless the lane encroachment permits a remaining lane width of 3 m (10 ft), the lane should be closed.

Truck off-tracking should be considered when determining whether the minimum lane width of 3 m (10 ft) is adequate.

Option:

A lane width of 2.7 m (9 ft) may be used for short-term stationary work on low-volume, low-speed roadways when motor vehicle traffic does not include longer and wider heavy commercial vehicles.

Support:

Figure 6H-6 illustrates a method for handling motor vehicle traffic where the stationary or short duration work space encroaches slightly into the traveled way.

Section 6G.08 Work Within the Median**Guidance:**

If work in the median of a divided highway is within 4.5 m (15 ft) from the edge of the traveled way for either direction of travel, temporary traffic control should be used through the use of advance warning signs and channelizing devices.

Section 6G.09 Work Within the Traveled Way of Two-Lane Highways**Support:**

Detour signs are used to direct road users onto another roadway. At diversions, road users are directed onto a temporary roadway or alignment placed within or adjacent to the right-of-way. Typical applications for detouring or diverting road users on two-lane highways are shown in Figures 6H-7, 6H-8, and 6H-9. Figure 6H-7 illustrates the controls around an area where a section of roadway has been closed and a diversion has been constructed. Channelizing devices and pavement markings are used to indicate the transition to the temporary roadway.

Guidance:

When a detour is long, Detour Marker (M4-8) or Detour (M4-9) signs should be installed to remind and reassure road users periodically that they are still successfully following the detour.

When an entire roadway is closed, as illustrated in Figure 6H-8, a detour should be provided and road users should be warned in advance of the closure, which in this example is a closure 16 km (10 mi) from the intersection. If local road users are allowed to use the roadway up to the closure, the ROAD CLOSED TO THRU TRAFFIC sign should be used. The portion of the road open to local road users should have adequate signing, marking, and delineation.

Detours should be signed so that road users will be able to traverse the entire detour route and back to the original roadway as shown in Figure 6H-9.

Support:

Techniques for controlling motor vehicle traffic under one-lane, two-way conditions are described in Section 6C.10.

Option:

Flaggers may be used as shown in Figure 6H-10.

STOP/YIELD sign control may be used on low-volume roads as shown in Figure 6H-11.

A temporary traffic control signal may be used as shown in Figure 6H-12.

Section 6G.10 Work Within the Traveled Way of Urban Streets

Support:

In urban temporary traffic control zones, decisions are needed on how to control motor vehicle traffic, such as how many lanes are required, whether any turns should be prohibited at intersections, and how to maintain access to business, industrial, and residential areas.

Pedestrian traffic needs separate attention. Chapter 6D contains information regarding controlling pedestrian movements near work zones.

Standard:

If the temporary traffic control zone affects the movement of pedestrians, adequate pedestrian access and walkways shall be provided.

If the temporary traffic control zone affects the movement of bicyclists, adequate access to the roadway, bicycle paths, or shared-use paths shall be provided (see Part 9).

Guidance:

If a designated bicycle route is closed because of the work being done, a signed alternate route should be provided. Bicyclists should not be directed onto the path used by pedestrians.

Support:

Utility work takes place both within and outside the roadway to construct and maintain services such as power, gas, light, water, or telecommunications. Operations often involve intersections, since that is where many of the network junctions occur. The work force is usually small, only a few vehicles are involved, and the number and types of temporary traffic control devices placed in the temporary traffic control zone is usually minimal.

Standard:

All temporary traffic control devices shall be retroreflective or illuminated if utility work is performed during nighttime hours.

Guidance:

As discussed under short-duration projects, however, the reduced number of devices in utility work zones should be offset by the use of high-visibility devices, such as rotating lights or strobe lights on work vehicles.

Support:

Figures 6H-6, 6H-10, 6H-15, 6H-18, 6H-21, 6H-22, 6H-23, 6H-26, and 6H-33 are examples of typical applications for utility operations. Other typical applications might apply as well.

Section 6G.11 Work Within the Traveled Way of Multi-Lane, Non-Access Controlled Highways**Support:**

Work on multi-lane (two or more lanes in one direction) highways is divided into right-lane closures, left-lane closures, interior-lane closures, multiple-lane closures, and closures on five-lane roadways.

Standard:

When a lane is closed on a multi-lane road, a transition area containing a merging taper shall be used.

Guidance:

When justified by an engineering study, temporary traffic barriers should be used to prevent incursions of errant vehicles into hazardous areas or work space.

Standard:

When temporary traffic barriers are placed immediately adjacent to the traveled way, they shall be equipped with appropriate channelizing devices, delineation, and/or other temporary traffic control devices. For lane closures, the merging taper shall use channelizing devices and the temporary traffic barrier shall be placed beyond the transition area.

Support:

It must be recognized that although temporary traffic barriers are shown in several of the typical applications of Chapter 6H, they are not considered to be temporary traffic control devices in themselves.

Figure 6H-34 illustrates a lane closure in which temporary traffic barriers are used.

There are four primary functions of temporary traffic barriers:

- A. To keep motor vehicle traffic from entering work areas, such as excavations or material storage sites;
- B. To separate workers, bicyclists, and pedestrians from motor vehicle traffic;
- C. To separate opposing directions of motor vehicle traffic; and,
- D. To separate motor vehicle traffic, bicyclists, and pedestrians from the work area such as false work for bridges and other exposed objects.

Option:

When the right lane is closed, temporary traffic control similar to that shown in Figure 6H-33 may be used for undivided or divided four-lane roads.

Guidance:

If morning and evening peak hourly motor vehicle traffic volumes in the two directions are uneven and the greater volume is on the side where the work is being done in the right lane, consideration should be given to closing the inside lane for opposing motor vehicle traffic and making the lane available to the side with heavier motor vehicle traffic, as shown in Figure 6H-31.

If the larger motor vehicle traffic volume changes to the opposite direction at a different time of the day, the temporary traffic control should be changed to allow two lanes for opposing motor vehicle traffic by moving the devices from the opposing lane back to the centerline. When it is necessary to create a temporary centerline that is not consistent with the pavement markings, channelizing devices should be used and closely spaced.

Option:

When closing a left lane on a multi-lane undivided road, as motor vehicle traffic flow permits, the two interior lanes may be closed, as shown in Figure 6H-30, to provide drivers and workers additional lateral clearance and to provide access to the work space.

Standard:

When only the left lane is closed on undivided roads, channelizing devices shall be placed along the centerline as well as along the adjacent lane.

Guidance:

When an interior lane is closed, an adjacent lane should also be considered for

closure to provide additional space for vehicles and materials and to facilitate the movement of equipment within the work space.

When multiple lanes in one direction are closed, a capacity analysis should be made to determine the number of lanes needed to accommodate motor vehicle traffic needs. Motor vehicle traffic should be moved over one lane at a time. As shown in Figure 6H-37, the tapers should be separated by a distance of $2L$, with L being determined by the formulas in Table 6C-2.

Standard:

When a directional roadway is closed, inapplicable WRONG WAY signs and markings, and other existing traffic control devices at intersections within the temporary two-lane, two-way operations section shall be covered, removed, or obliterated.

Option:

When half the road is closed on an undivided highway, both directions of motor vehicle traffic may be accommodated as shown in Figure 6H-32. When both interior lanes are closed, temporary traffic controls may be used as indicated in Figure 6H-30. When a roadway must be closed on a divided highway, a median crossover may be used (see Section 6G.15).

Support:

Temporary traffic control for lane closures on five-lane roads is similar to other multi-lane undivided roads. Figure 6H-32 can be adapted for use on five-lane roads. Figure 6H-35 can be used on a five-lane road for short duration and mobile operations.

Section 6G.12 Work Within the Traveled Way at an Intersection

Support:

The typical applications for intersections are classified according to the location of the work space with respect to the intersection area (as defined by the extension of the curb or edge lines). The three classifications are near side, far side, and in-the-intersection. Work spaces often extend into more than one portion of the intersection. For example, work in one quadrant often creates a near-side work space on one street and a far-side work space on the cross street. In such instances, an appropriate temporary traffic control plan is obtained by combining features shown in two or more of the intersection and pedestrian typical applications.

Temporary traffic control zones in the vicinity of intersections might block movements and interfere with normal road user flows. Such conflicts frequently occur at more complex signalized intersections having such features as traffic signal heads over particular lanes, lanes allocated to specific movements, multiple signal phases, and signal detectors for actuated control.

Guidance:

The effect of the work upon signal operation should be considered, such as signal phasing for ensuring adequate capacity, maintaining or adjusting signal detectors, and ensuring the appropriate visibility of signal heads.

Standard:

When work will occur near signalized intersections where operational and capacity problems are anticipated, the highway agency having jurisdiction shall be contacted.

Guidance:

When work will occur near non-signalized intersections where operational and capacity problems are anticipated, the highway agency having jurisdiction should be contacted.

For work at an intersection, advance warning signs, devices, and markings should be used on all cross streets, as appropriate. The typical applications depict urban intersections on arterial streets. Where the posted speed limit, the off-peak 85th-percentile speed prior to the work starting, or the anticipated speed exceeds 60 km/h (40 mph), additional warning signs should be used in the advance warning area.

Support:

Near-side work spaces, as depicted in Figure 6H-21, are simply handled as a midblock lane closure. A problem that might occur with near-side lane closure is a reduction in capacity, which during certain hours of operation could result in congestion and backups.

Option:

When near-side work spaces are used, an exclusive turn lane may be used for through motor vehicle traffic.

Where space is restricted in advance of near-side work spaces, as with short block spacings, two warning signs may be used in the advance warning area, and a third action-type warning or a regulatory sign (such as Keep Left) may be placed within the transition area.

Support:

Far-side work spaces, as depicted in Figures 6H-22 through 6H-25, involve additional treatment because road users typically enter the activity area by straight-through and left- or right-turning movements.

Guidance:

When a lane through an intersection must be closed on the far side, it should also be closed on the near-side approach to preclude merging movements within the intersection.

Option:

If, however, there are a significant number of vehicles turning from a near-side lane that is closed on the far side, the near-side lane may be converted to an exclusive turn lane.

Support:

Figures 6H-26 and 6H-27 provide guidance on applicable procedures for work performed within the intersection.

Option:

If the work is within the intersection, any of the following strategies may be used:

- A. A small work space so that road users can move around it, as shown in Figure 6H-26.
- B. Flaggers to assign the right-of-way, as shown in Figure 6H-27.
- C. Work in stages so the work space is kept small.
- D. Reduce road user volumes by road closing or upstream diversions.

Guidance:

Depending on road user conditions, a flagger(s) and/or a uniformed law enforcement officer(s) should be used to control road users.

Section 6G.13 Work Within the Traveled Way of Expressways and Freeways**Support:**

Problems of temporary traffic control might occur under the special conditions encountered where motor vehicle traffic must be moved through or around temporary traffic control zones on high-speed, high-volume roadways. Although the general principles outlined in the previous Sections of this Manual are applicable to all types of highways, high-speed, access-controlled highways need special attention in order to safely and efficiently accommodate motor vehicle traffic while also protecting work forces. The road user volumes, road vehicle mix (buses, trucks, and cars), and speed of vehicles on these facilities require that careful temporary traffic control procedures be implemented, for example, to induce critical merging maneuvers well in advance of work spaces and in a manner that creates minimum turbulence and delay in the motor vehicle traffic stream. These situations often require more conspicuous devices than specified for normal rural highway or urban street use. However, the same important basic considerations of uniformity and standardization of general principles apply for all roadways.

Work under high-speed, high-volume motor vehicle traffic on a controlled access highway is complicated by the roadway design and operational features. The presence of a median that establishes separate roadways for directional motor vehicle traffic flow might prohibit the closing of one of the roadways or the diverting of motor vehicle traffic to the other roadway. Lack of access to and from adjacent roadways prohibits rerouting of motor vehicle traffic away from the work space in many cases. Other conditions exist where work must be limited to night hours, thereby necessitating increased use of warning lights, illumination of work spaces, and advance warning systems.

Temporary traffic control for a typical lane closure on a divided highway is shown in Figure 6H-33. Temporary traffic controls for short duration and mobile operations on freeways are shown in Figure 6H-35. A typical application for shifting motor vehicle traffic lanes around a work space is shown in Figure 6H-36. Temporary traffic control for multiple and interior lane closures on a freeway is shown in Figures 6H-37 and 6H-38.

Guidance:

The method for closing an interior lane when the open lanes have the capacity to carry motor vehicle traffic should be as shown in Figure 6H-37. When the capacity of the other lanes is needed, the method shown in Figure 6H-38 should be used.

Section 6G.14 Two-Lane, Two-Way Traffic on One Roadway of a Normally Divided Highway

Support:

Two-lane two-way operation on one roadway of a normally divided highway is a typical procedure that requires special consideration in the planning, design, and work phases, because unique operational problems (for example, increasing the risk of head-on crashes) can arise with the two-lane, two-way operation.

Standard:

When two-lane, two-way traffic control must be maintained on one roadway of a normally divided highway, opposing motor vehicle traffic shall be separated with either temporary traffic barriers (concrete safety-shape or approved alternate) or with channelizing devices throughout the length of the two-way operation. The use of markings and complementary signing, by themselves, shall not be used.

Support:

Figure 6H-39 shows the procedure for two-lane, two-way operation. Treatments for entrance and exit ramps within the two-way roadway segment of this type of work are shown in Figures 6H-40 and 6H-41.

Section 6G.15 Crossovers**Guidance:**

The following are considered good guiding principles for the design of crossovers:

- A. Tapers for lane drops should be separated from the crossovers, as shown in Figure 6H-39.
- B. Crossovers should be designed for speeds no lower than 15 km/h (10 mph) below the posted speed, the off-peak 85th-percentile speed prior to the work starting, or the anticipated operating speed of the roadway, unless unusual site conditions require that a lower design speed be used.
- C. A good array of channelizing devices, delineators, and full-length, properly-placed pavement markings should be used to provide drivers with a clearly-defined travel path.
- D. The design of the crossover should accommodate all motor vehicle traffic, including trucks and buses.

Support:

Temporary traffic barriers and the excessive use of temporary traffic control devices cannot compensate for poor geometric and roadway cross-section design of crossovers.

Section 6G.16 Interchanges**Guidance:**

Access to interchange ramps on limited-access highways should be maintained even if the work space is in the lane adjacent to the ramps. Access to exit ramps should be clearly marked and delineated with channelizing devices. For long-term projects, conflicting pavement markings should be removed and new ones placed. Early coordination with officials having jurisdiction over the affected cross streets and providing emergency services should occur before ramp closings.

Option:

If access is not possible, ramps may be closed by using signs and Type III barricades. As the work space changes, the access area may be changed, as shown in Figure 6H-42. A temporary traffic control zone in the exit ramp may be handled as shown in Figure 6H-43.

When a work space interferes with an entrance ramp, a lane may need to be closed on the freeway. A temporary traffic control zone in the entrance ramp may require shifting ramp motor vehicle traffic. Temporary traffic control for both operations is shown in Figure 6H-44.

Section 6G.17 Movable Barriers

Support:

Figure 6H-45 shows a temporary reversible lane using movable barriers.

Option:

If the work activity in Figure 6H-34 permits, a movable barrier may be used and relocated to the shoulder during non-work periods or peak-period motor vehicle traffic conditions.

Section 6G.18 Work in the Vicinity of Highway-Rail Grade Crossings

Standard:

When highway-rail grade crossings exist either within or in the vicinity of a temporary traffic control zone, lane restrictions, flagging, or other operations shall not create conditions where vehicles can be stopped on the railroad tracks with no means of escape.

If the queuing of vehicles across the tracks cannot be avoided, a law enforcement officer or flagger shall be provided at the crossing to prevent vehicles from stopping on the tracks, even if automatic warning devices are in place.

Support:

Figure 6H-46 shows work in the vicinity of a highway-rail grade crossing.

Guidance:

Early coordination with the railroad company should occur before work starts.

Section 6G.19 Control of Traffic Through Incident Areas

Support:

An incident is an emergency road user occurrence, a natural disaster, or a special event.

The primary functions of temporary traffic control at an incident area are to move road users safely and expeditiously through or around the incident, and to reduce the likelihood of secondary crashes. Examples include a stalled vehicle blocking a lane, a road user crash blocking the traveled way, a chemical spill along a highway, floods and severe storm damage, a planned visit by a dignitary, or a major sporting event.

Guidance:

In order to reduce response time for incident management, highway agencies should pre-plan for occurrences of incidents along the major and heavily traveled highway and street system. Special events should be planned for and coordinated in advance.

Support:

While some incidents might be anticipated and planned for, emergencies and disasters might pose more severe and unpredictable problems. The ability to install proper temporary traffic control might greatly reduce the effects of an emergency. An essential part of fire, rescue, spill clean-up, and enforcement activities is the proper control of road users through the incident area. These operations need corroborating legislative authority for the implementation and enforcement of appropriate road user regulations, parking controls, and speed zoning. It is desirable for these statutes to provide sufficient flexibility in the authority for and implementation of temporary traffic control to respond to the needs of changing conditions found in incident areas.

Option:

For unexpected incidents, particularly those of an emergency nature, temporary traffic control devices on hand may be used for the initial response as long as they do not themselves create unnecessary additional hazards.

Standard:

If the incident is anticipated to last more than 3 days, applicable procedures and devices set forth in Part 6 shall be used.

Support:

A short-term road closure can be caused by an incident such as a road user crash that blocks the traveled way. Road users are usually detoured around the incident and back to the original roadway. A combination of traffic engineering and enforcement preparations is needed to determine the detour route and install the necessary devices. Large trucks are a significant concern in such a detour.

During incidents, large trucks might need to follow a route separate from that of automobiles because of bridge, weight, clearance, or geometric restrictions. Also, vehicles carrying hazardous cargo might need to follow a different route from other vehicles.

Some incidents such as hazardous spills might require closure of an entire highway. Through road users must have adequate guidance around the incident.

Maintaining good public relations is desirable. The cooperation of the news media in publicizing the existence of and reasons for incident areas and their temporary traffic control can be of great assistance in keeping road users and the general public well informed.

Guidance:

The channelizing devices discussed in Section 6F.55 should be used whenever possible.

When flares are used to initiate temporary traffic control at incidents or for short-term temporary traffic control, they should be replaced by more permanent devices as soon as practical.

CHAPTER 6H. TYPICAL APPLICATIONS

Section 6H.01 Typical Applications

Support:

Chapter 6G contains discussions of typical temporary traffic control activities. Chapter 6H presents typical applications for a variety of situations commonly encountered. While not every situation is addressed, the information illustrated can generally be adapted to a broad range of conditions. In many instances, an appropriate temporary traffic control plan is achieved by combining features from various typical applications. For example, work at an intersection might present a near-side work zone for one street and a far-side work zone for the other street. These treatments are found in two different typical applications, while a third typical application shows how to handle pedestrian crosswalk closures.

Procedures for establishing temporary traffic control zones vary with such conditions as road configuration, location of the work, work activity, duration of work, road user volumes, road vehicle mix (buses, trucks, and cars), and road user speeds. Examples presented in this Chapter are guides showing how to apply principles and standards. Applying these guidelines to actual situations and adjusting to field conditions requires judgment. In general, the procedures illustrated represent minimum solutions for the situations depicted.

Option:

Other devices may be added to supplement the devices and device spacing may be adjusted to provide additional reaction time or delineation. Fewer devices may be used based on field conditions.

Support:

Figures and tables found throughout Part 6 provide information for the development of temporary traffic control plans. Table 6C-2 is used for the determination of taper lengths, while Table 6C-1 can be used for sign spacing for various area and roadway types.

Table 6H-1 is an index of the 46 typical applications. Typical applications are shown on the right page with notes on the facing page to the left. The legend for the symbols used in the typical applications is provided in Table 6H-2. In many of the typical applications, sign spacings and other dimensions are indicated by letters using the criteria provided in Table 6H-3.

Most of the typical applications show temporary traffic control devices for only one direction.



















Table 6H-1. Index to Typical Applications (Sheet 1 of 2)

Typical Application Description	Typical Application Number
Work Outside of Shoulder (see Section 6G.05)	
Work Beyond the Shoulder	TA-1
Blasting Zone	TA-2
Work on the Shoulder (see Sections 6G.06 and 6G.07)	
Work on Shoulders	TA-3
Short Duration or Mobile Operation on Shoulder	TA-4
Shoulder Closure on Freeway	TA-5
Shoulder Work with Minor Encroachment	TA-6
Work Within the Traveled Way of Two-Lane Highways (see Section 6G.09)	
Road Closed with Diversion	TA-7
Roads Closed with Off-Site Detour	TA-8
Overlapping Routes with Detour	TA-9
Lane Closure on Two-Lane Road Using Flaggers	TA-10
Lane Closure on Low-Volume, Two-Lane Road	TA-11
Lane Closure on Two-Lane Road Using Traffic Control Signals	TA-12
Temporary Road Closure	TA-13
Haul Road Crossing	TA-14
Work in Center of Low-Volume Road	TA-15
Surveying Along Centerline of Low-Volume Road	TA-16
Mobile Operations on Two-Lane Road	TA-17
Work Within the Traveled Way of Urban Streets (see Section 6G.10)	
Lane Closure on Minor Street	TA-18
Detour for One Travel Direction	TA-19
Detour for Closed Street	TA-20
Work Within the Traveled Way at an Intersection and Sidewalks (see Section 6G.12)	
Lane Closure on Near Side of Intersection	TA-21
Right Lane Closure on Far Side of Intersection	TA-22
Left Lane Closure on Far Side of Intersection	TA-23
Half Road Closure on Far Side of Intersection	TA-24
Multiple Lane Closures at Intersection	TA-25
Closure in Center of Intersection	TA-26
Closure at Side of Intersection	TA-27
Sidewalk Closures and Bypass Sidewalks	TA-28
Crosswalk Closures and Pedestrian Detours	TA-29

Table 6H-1. Index to Typical Applications (Sheet 2 of 2)

Typical Application Description	Typical Application Number
Work Within the Traveled Way of Multi-Lane Undivided Highways (see Section 6G.11)	
Interior Lane Closure on Multi-Lane Street	TA-30
Lane Closure on Street with Uneven Directional Volumes	TA-31
Half Road Closure on Multi-Lane, High-Speed Highway	TA-32
Work Within the Traveled Way of Multi-Lane Divided Highways (see Section 6G.11)	
Lane Closure on Divided Highway	TA-33
Lane Closure with Temporary Traffic Barrier	TA-34
Mobile Operation on Multi-Lane Road	TA-35
Work Within the Traveled Way of Expressways and Freeways (see Section 6G.13)	
Lane Shift on Freeway	TA-36
Double Lane Closure on Freeway	TA-37
Interior Lane Closure on Freeway	TA-38
Median Crossover on Freeway	TA-39
Median Crossover for Entrance Ramp	TA-40
Median Crossover for Exit Ramp	TA-41
Work in Vicinity of Exit Ramp	TA-42
Partial Exit Ramp Closure	TA-43
Work in Vicinity of Entrance Ramp	TA-44
Temporary Reversible Lane Using Movable Barriers	TA-45
Work in the Vicinity of Highway-Rail Grade Crossings (see Section 6G.18)	
Work in Vicinity of Highway-Rail Grade Crossing	TA-46

Table 6H-2. Meaning of Symbols on Typical Application Diagrams

	Arrow panel
	Arrow panel support or trailer
	Channelizing device
	Direction of traffic
	Direction of temporary traffic detour
	Flagger
	High level warning device (Flag tree)
	Luminaire
	Pavement markings that should be removed for a long term project
	Sign (Shown facing left)
	Temporary barrier
	Temporary barrier with warning lights
	Surveyor
	Traffic or Pedestrian signal
	Truck mounted attenuator
	Type III Barricade
	Crash Cushion
	Changeable message sign or support trailer
	Warning lights
	Work space
	Work vehicle

**Table 6H-3. Meaning of Letter Codes on
Typical Application Diagrams**

Road Type	Distance Between Signs**		
	A	B	C
Urban (low speed)*	30 (100)	30 (100)	30 (100)
Urban (high speed)*	100 (350)	100 (350)	100 (350)
Rural	150 (500)	150 (500)	150 (500)
Expressway / Freeway	300 (1,000)	450 (1,500)	800 (2,640)

* Speed category to be determined by highway agency

** Distances are shown in meters (feet). The column headings A, B, and C are the dimensions shown in Figures 6H-1 through 6H-46. The A dimension is the distance from the transition or point of restriction to the first sign. The B dimension is the distance between the first and second signs. The C dimension is the distance between the second and third signs. (The third sign is the first one in a three-sign series encountered by a driver approaching a temporary traffic control zone.)

Formulas for L are as follows:

For speed limits of 60 km/h (40 mph) or less:

$$L = \frac{WS^2}{150} \quad (L = \frac{WS^2}{60})$$

For speed limits of 70 km/h (45 mph) or greater:

$$L = \frac{WS}{1.6} \quad (L = WS)$$

Where: L = taper length in meters (feet)

W = width of offset in meters (feet)

S = posted speed limit, or off-peak

85th-percentile speed prior to work starting,
or the anticipated operating speed in km/h (mph)

Notes for Figure 6H-1 – Typical Application 1

Work Beyond the Shoulder

Guidance:

1. If the work space is in the median of a divided highway, an advance warning sign should also be placed on the left side of the directional roadway.

Option:

2. The ROAD WORK AHEAD sign may be replaced with other appropriate signs such as the SHOULDER WORK sign. The SHOULDER WORK sign may be used for work adjacent to the shoulder.
3. The ROAD WORK AHEAD sign may be omitted where the work space is behind a barrier, more than 600 mm (24 in) behind the curb, or 4.5 m (15 ft) or more from the edge of any roadway.
4. For short-term, short-duration or mobile operation, all signs and channelizing devices may be eliminated if a vehicle with activated rotating lights or strobe lights is used.

Standard:

- 5. Although vehicle hazard warning signals can be used to supplement the rotating lights or strobe lights, they shall not be used instead of rotating lights or strobe lights.**

Figure 6H-1. Work Beyond the Shoulder (TA-1)

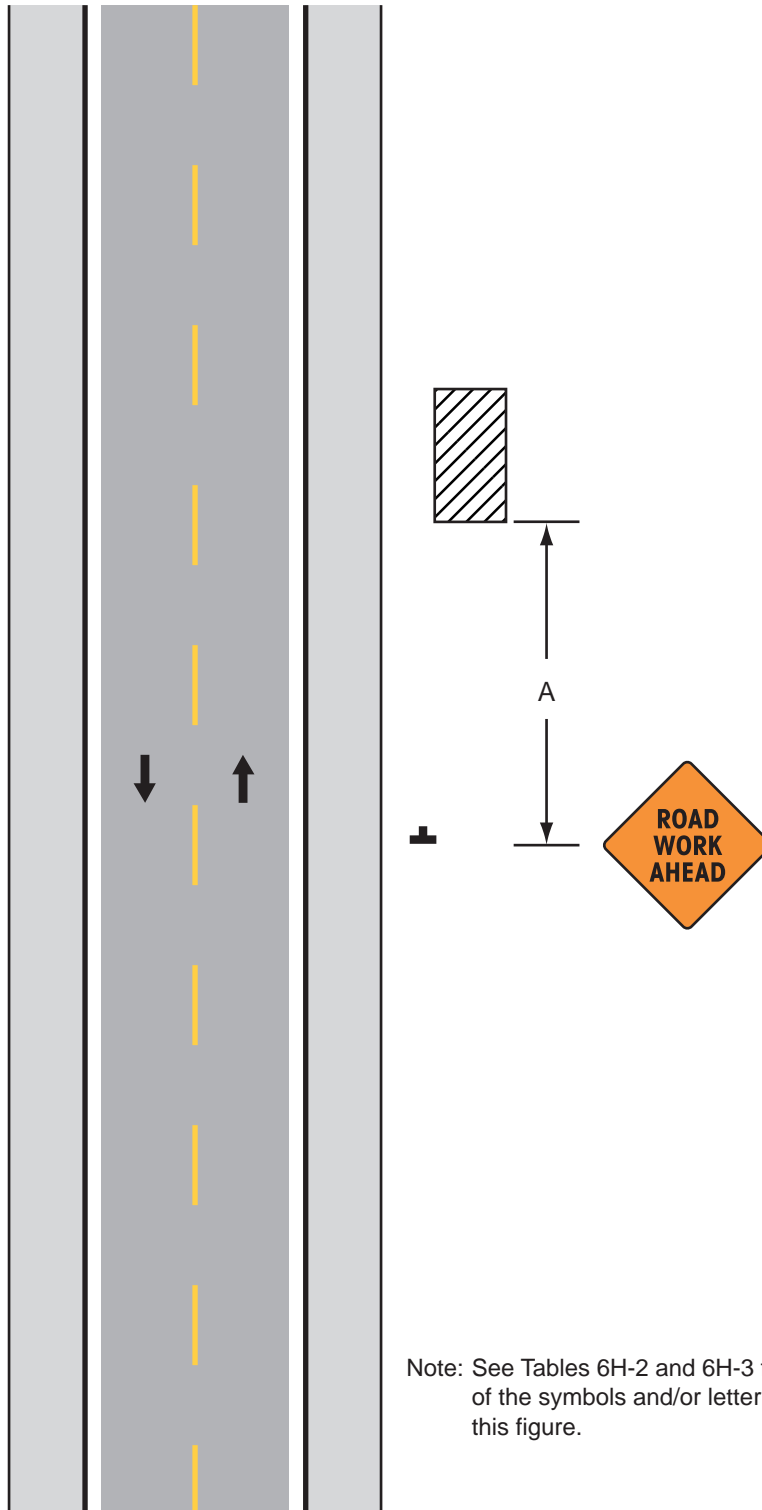

Typical Application 1

Note: See Tables 6H-2 and 6H-3 for the meaning of the symbols and/or letter codes used in this figure.

Notes for Figure 6H-2 – Typical Application 2

Blasting Zone

Standard:

1. Whenever blasting caps are used within 300 m (1,000 ft) of a roadway, the signing shown shall be used.
2. The signs shall be covered or removed when there are no explosives in the area or the area is otherwise secure.
3. Whenever a side road intersects the roadway between the **BLASTING ZONE AHEAD** sign and the **END BLASTING ZONE** sign, or a side road is within 300 m (1,000 ft) of any blasting cap, similar signing, as on the mainline, shall be installed on the side road.
4. Prior to blasting, the blaster in charge shall determine whether road users in the blasting zone will be endangered by the blasting operation. If there is danger, road users shall not be permitted to pass through the blasting zone during blasting operations.

Guidance:

5. On a divided highway, the signs should be mounted on both sides of the directional roadways.

Figure 6H-2. Blasting Zone (TA-2)

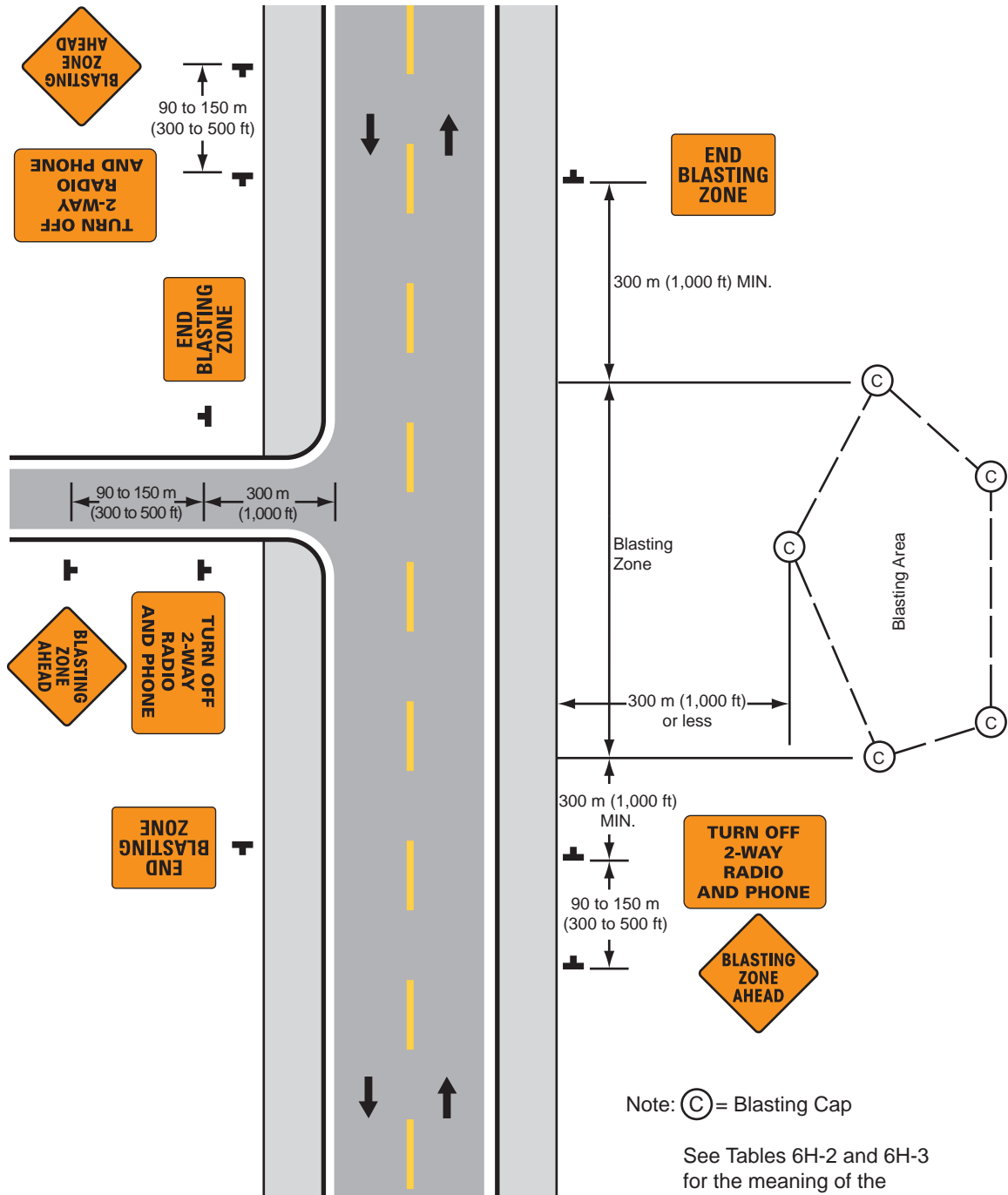

Note: (C) = Blasting Cap

See Tables 6H-2 and 6H-3 for the meaning of the symbols and/or letter codes used in this figure.

Notes for Figure 6H-3 – Typical Application 3

Work on Shoulders

Guidance:

1. A SHOULDER WORK sign should be placed on the left side of the roadway for a divided or one-way street only if the left shoulder is affected.

Option:

2. The Workers symbol signs may be used instead of SHOULDER WORK signs.
3. The SHOULDER WORK AHEAD sign on an intersecting roadway may be omitted where drivers emerging from that roadway will encounter another advance warning sign prior to this activity area.
4. For short-duration operations of 60 minutes or less, all signs and channelizing devices may be eliminated if a vehicle with activated rotating lights or strobe lights is used.

Standard:

- 5. Although vehicle hazard warning signals can be used to supplement the rotating lights or strobe lights, they shall not be used instead of rotating lights or strobe lights.**

Notes for Figure 6H-4 – Typical Application 4

Short-Duration or Mobile Operation on Shoulder

Guidance:

1. In those situations where multiple work locations within a limited distance make it practical to place stationary signs, the distance between the advance warning sign and the work should not exceed 8 km (5 mi).
2. In those situations where the distance between the advance signs and the work is 3.2 km (2 mi) to 8 km (5 mi), a Supplemental Distance plaque should be used with the ROAD WORK AHEAD sign.

Option:

3. The ROAD WORK NEXT XX KM (MILES) sign may be used instead of the ROAD WORK AHEAD sign if the work locations occur over a distance of more than 3.2 km (2 mi).
4. Warning signs may be omitted when the work vehicle displays rotating lights or strobe lights if the distance between work locations is 1.6 km (1 mile) or more, and if the work vehicle travels at motor vehicle traffic speeds between locations.

Standard:

5. **Although vehicle hazard warning signals can be used to supplement the rotating lights or strobe lights, they shall not be used instead of rotating lights or strobe lights.**
6. **If an arrow panel is used for an operation on the shoulder, the caution mode shall be used.**

Figure 6H-4. Short Duration or Mobile Operation on Shoulder (TA-4)

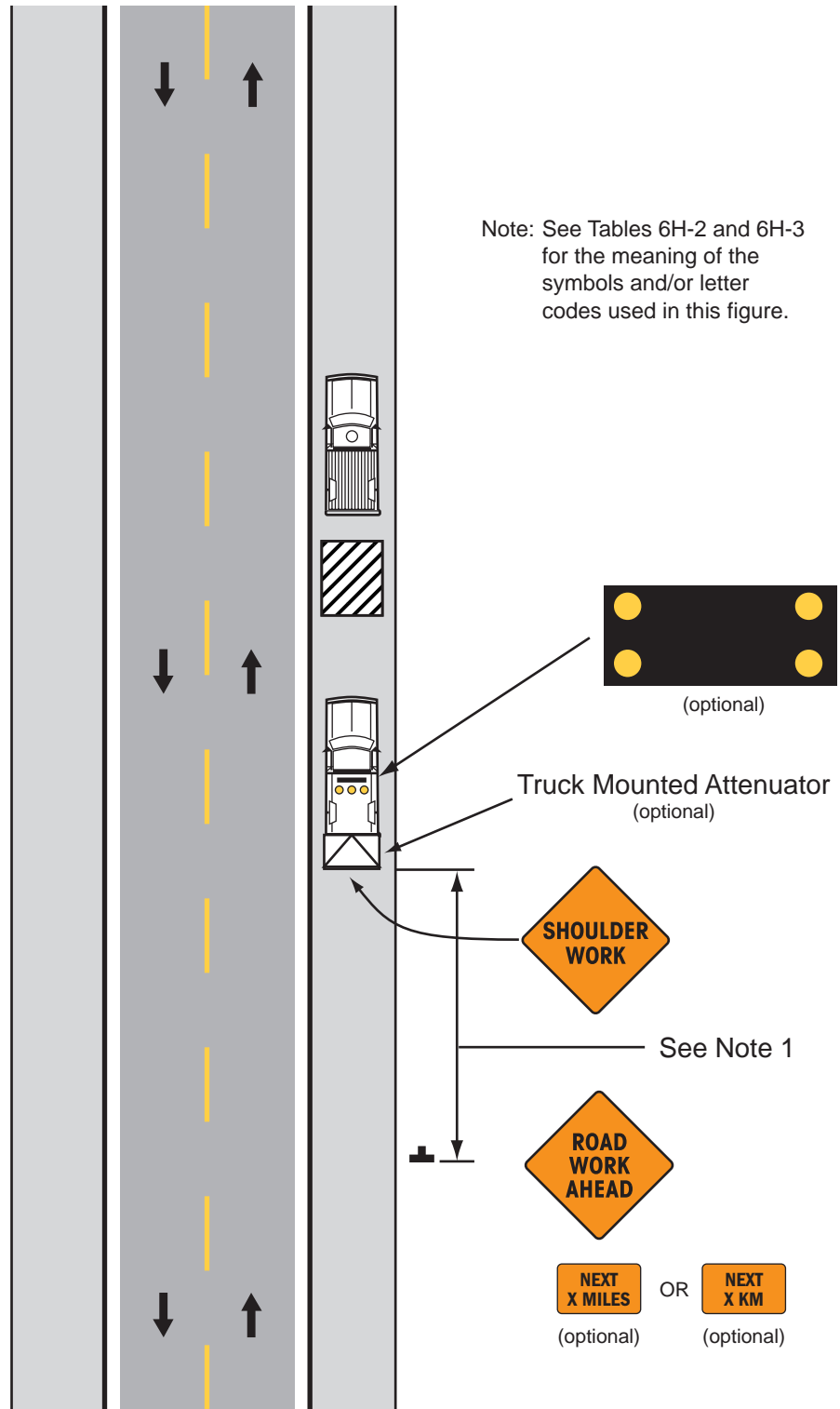

Typical Application 4

Notes for Figure 6H-5 – Typical Application 5

Shoulder Closure on Freeway

Guidance:

1. SHOULDER CLOSED signs should be used on limited-access highways where there is no opportunity for disabled vehicles to pull off the roadway.
2. If drivers cannot see a pull-off area beyond the closed shoulder, information regarding the length of the shoulder closure should be provided in meters or kilometers (feet or miles), as appropriate.
3. The use of a temporary traffic barrier should be based on engineering judgment.
4. Where temporary traffic barriers are installed, protection should be provided for the beginning of the barrier (see Section 6F.75).

Option:

5. The barrier shown in this typical application is an example of one method that may be used to close a shoulder of a long-term project.
6. The warning lights shown on the barrier may be used.

Figure 6H-5. Shoulder Closure on Freeway (TA-5)

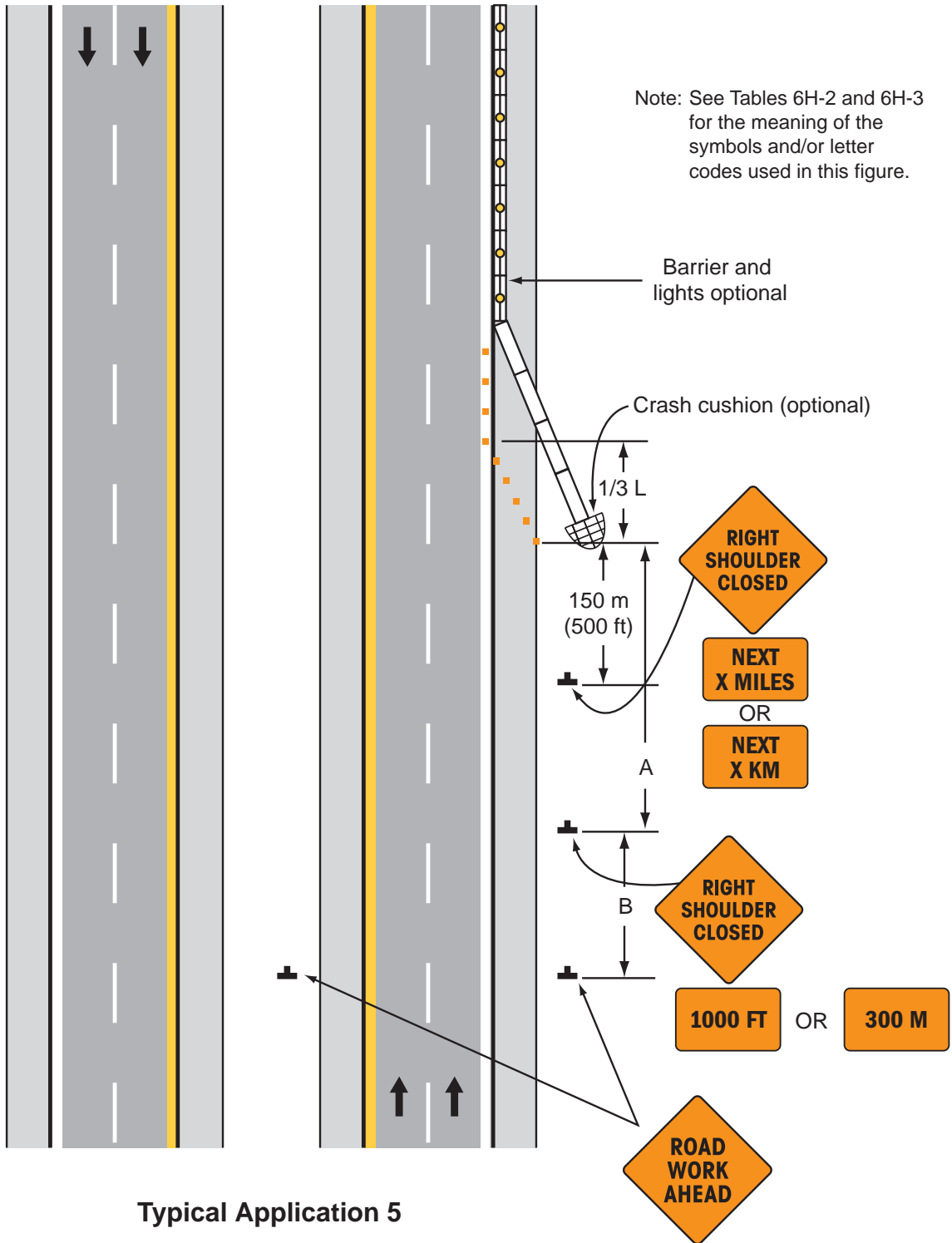

Notes for Figure 6H-6 – Typical Application 6

Shoulder Work with Minor Encroachment

Guidance:

1. All lanes should be a minimum of 3 m (10 ft) in width as measured to the near face of the channelizing devices.
2. The treatment shown should be used on a minor road having low speeds. For higher-speed traffic conditions, a lane closure should be used.

Option:

3. For short-term use on low-volume, low-speed roadways with motor vehicle traffic that does not include longer and wider heavy commercial vehicles, a minimum lane width of 2.7 m (9 ft) may be used.
4. Where the opposite shoulder is suitable for carrying motor vehicle traffic and of adequate width, lanes may be shifted by use of closely-spaced channelizing devices, provided that the minimum lane width of 3 m (10 ft) is maintained.
5. Additional advance warning may be appropriate, such as a ROAD NARROWS sign.
6. Temporary traffic barriers may be used along the work space.
7. The shadow vehicle may be omitted if a taper and channelizing devices are used.
8. A truck-mounted attenuator may be used on the shadow vehicle.
9. For short-duration work, the taper and channelizing devices may be omitted if a shadow vehicle with activated rotating lights or strobe lights is used.

Standard:

- 10. Although vehicle hazard warning signals can be used to supplement the rotating lights or strobe lights, they shall not be used instead of rotating lights or strobe lights.**

Figure 6H-6. Shoulder Work with Minor Encroachment (TA-6)

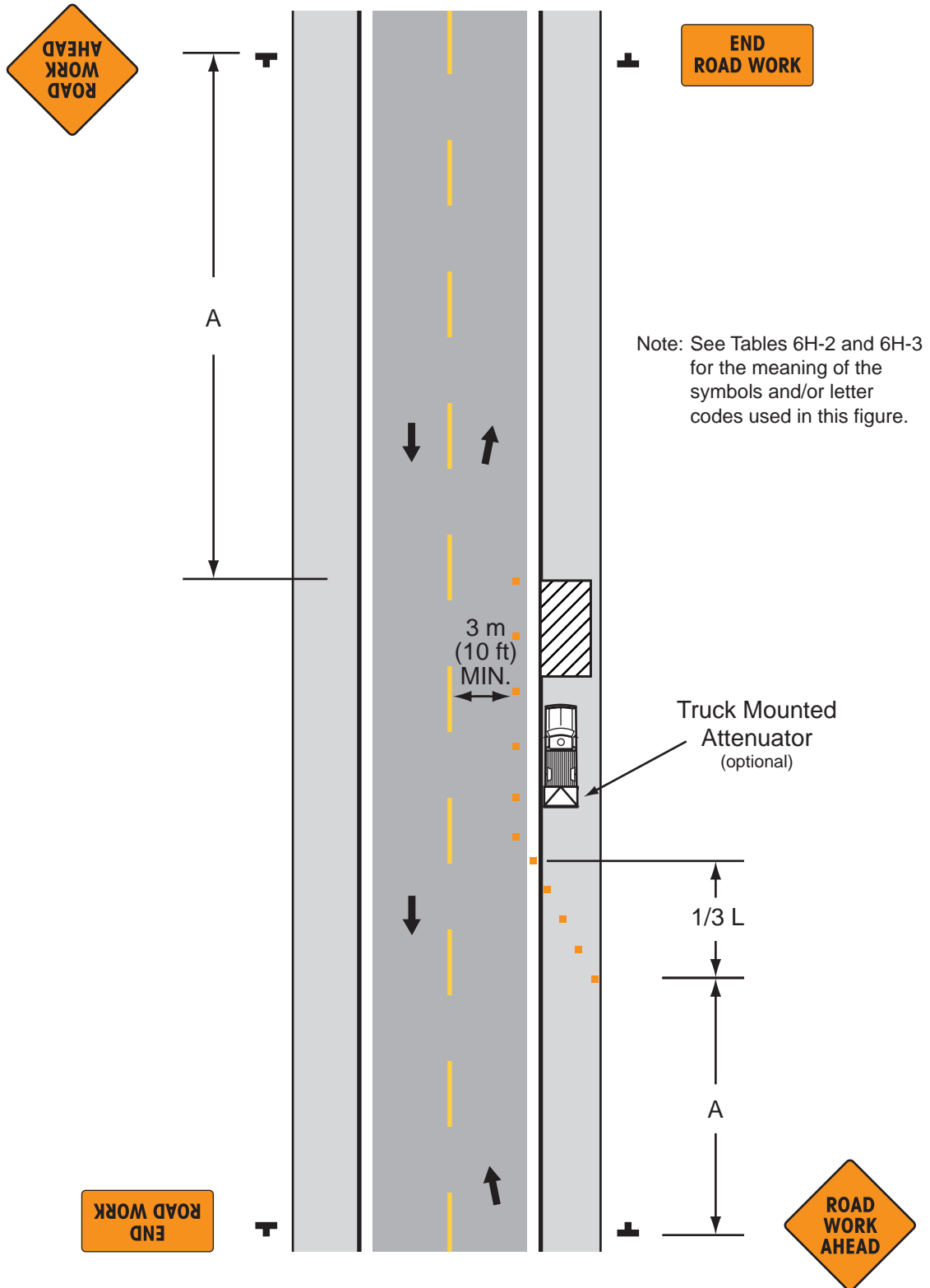

Typical Application 6

Notes for Figure 6H-7 – Typical Application 7

Road Closure with Diversion

Standard:

- 1. Signs and object markers are shown for one direction of travel only. Devices similar to those depicted shall be placed for the opposite direction of travel.**
- 2. Pavement markings no longer applicable shall be removed or obliterated as soon as practicable.**
- 3. Roadside barriers and end treatment shall be crashworthy.**

Guidance:

4. If the tangent distance along the temporary diversion is less than 180 m (600 ft), the Winding Road sign should be used at the location of the first Reverse Curve sign. The second Reverse Curve sign should be omitted.
5. Where the temporary pavement and old pavement are different colors, the temporary pavement should start on the tangent of the existing pavement and end on the tangent of the existing pavement.
6. If the diversion has sharp curves with recommended speeds of 50 km/h (30 mph) or less, Reverse Turn signs should be used.

Option:

7. Flashing warning lights and/or flags may be used to call attention to the warning signs.
8. On sharp curves, large arrow signs may be used in addition to other advance warning signs.
9. Delineators or channelizing devices may be used along the diversion.

Figure 6H-7. Road Closure with Diversion (TA-7)

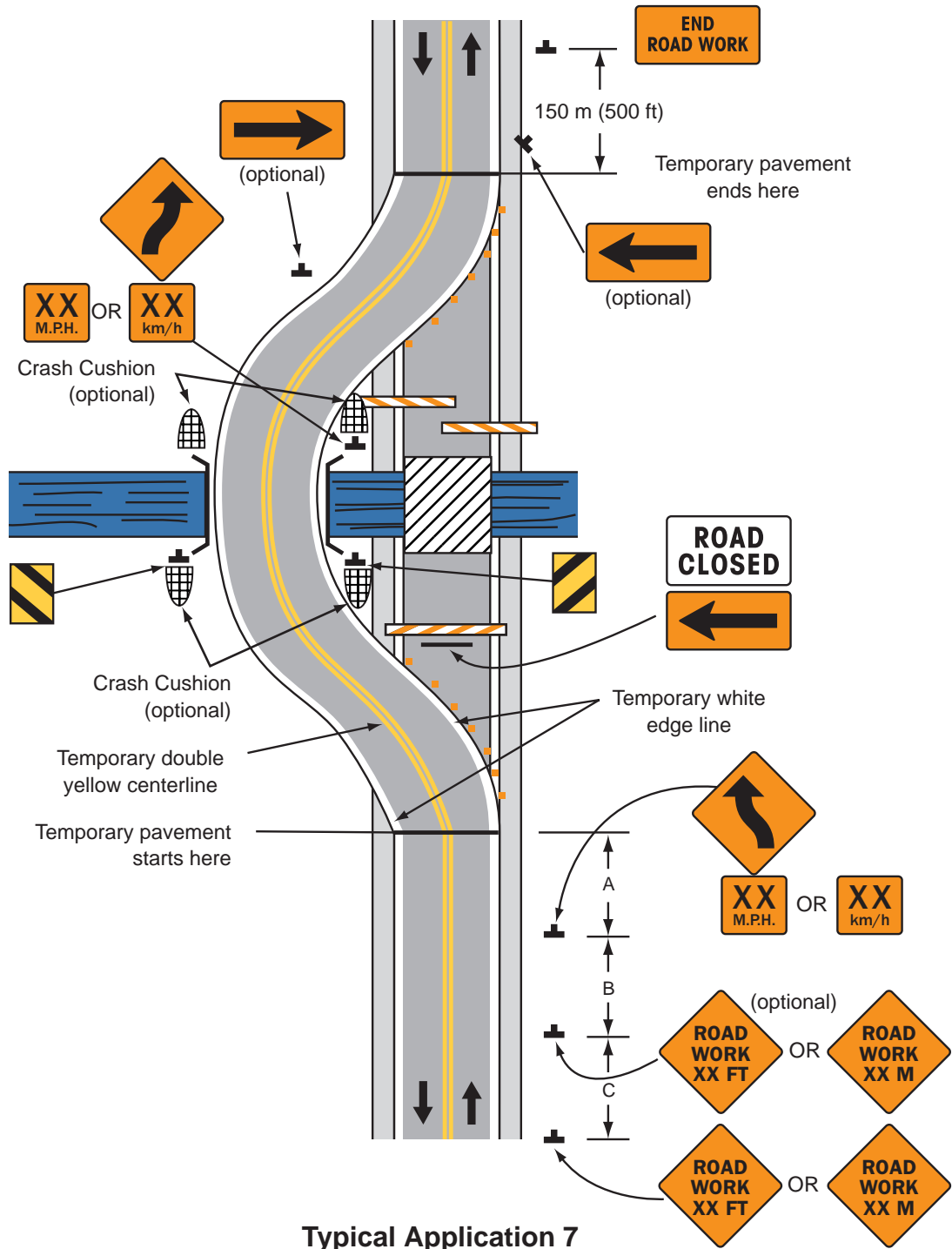

Note: See Tables 6H-2 and 6H-3 for the meaning of the symbols and/or letter codes used in this figure.

Notes for Figure 6H-8 – Typical Application 8

Road Closure with Off-Site Detour

Guidance:

1. Regulatory traffic control devices should be modified as needed for the duration of the detour.
2. If the road is opened for some distance beyond the intersection and/or there are significant origin/destination points beyond the intersection, the ROAD CLOSED and DETOUR signs on Type III Barricades should be located at the edge of the traveled way.

Option:

3. If the road is closed a short distance beyond the intersection and there are few origin/destination points beyond (for example, a few residences), the ROAD CLOSED and DETOUR sign may be placed on a Type III Barricade placed in the center of the roadway.
4. A Route Marker Directional assembly may be placed on the far left corner of the intersection to augment or replace the one shown on the near right corner.
5. Flashing warning lights and/or flags may be used to call attention to the advance warning signs.

Figure 6H-8. Road Closure with Off-Site Detour (TA-8)

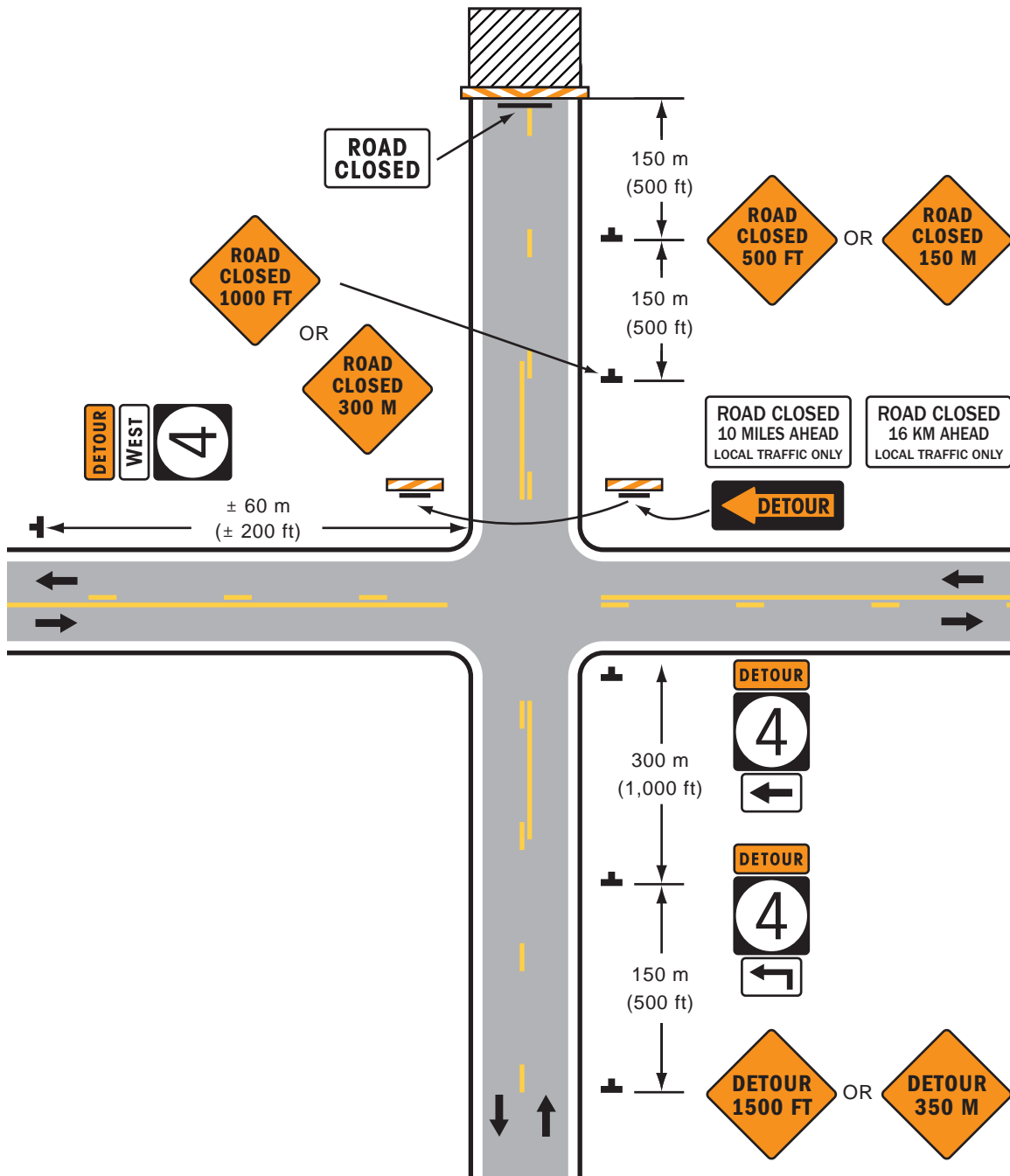

Typical Application 8

Note: See Tables 6H-2 and 6H-3 for the meaning of the symbols and/or letter codes used in this figure.

Notes for Figure 6H-9 – Typical Application 9

Overlapping Routes with Detour

Support:

1. Temporary traffic control devices are shown for one direction of travel only.

Standard:

2. **Devices similar to those depicted shall be placed for the opposite direction of travel.**

Guidance:

3. STOP signs displayed to side roads should be installed as needed along the temporary route.

Option:

4. Flashing warning lights and/or flags may be used to call attention to the advance warning signs.
5. Flashing warning lights may be used on the Type III Barricades.
6. Cardinal direction plaques may be used with route markers.

Figure 6H-9. Overlapping Routes with Detour (TA-9)

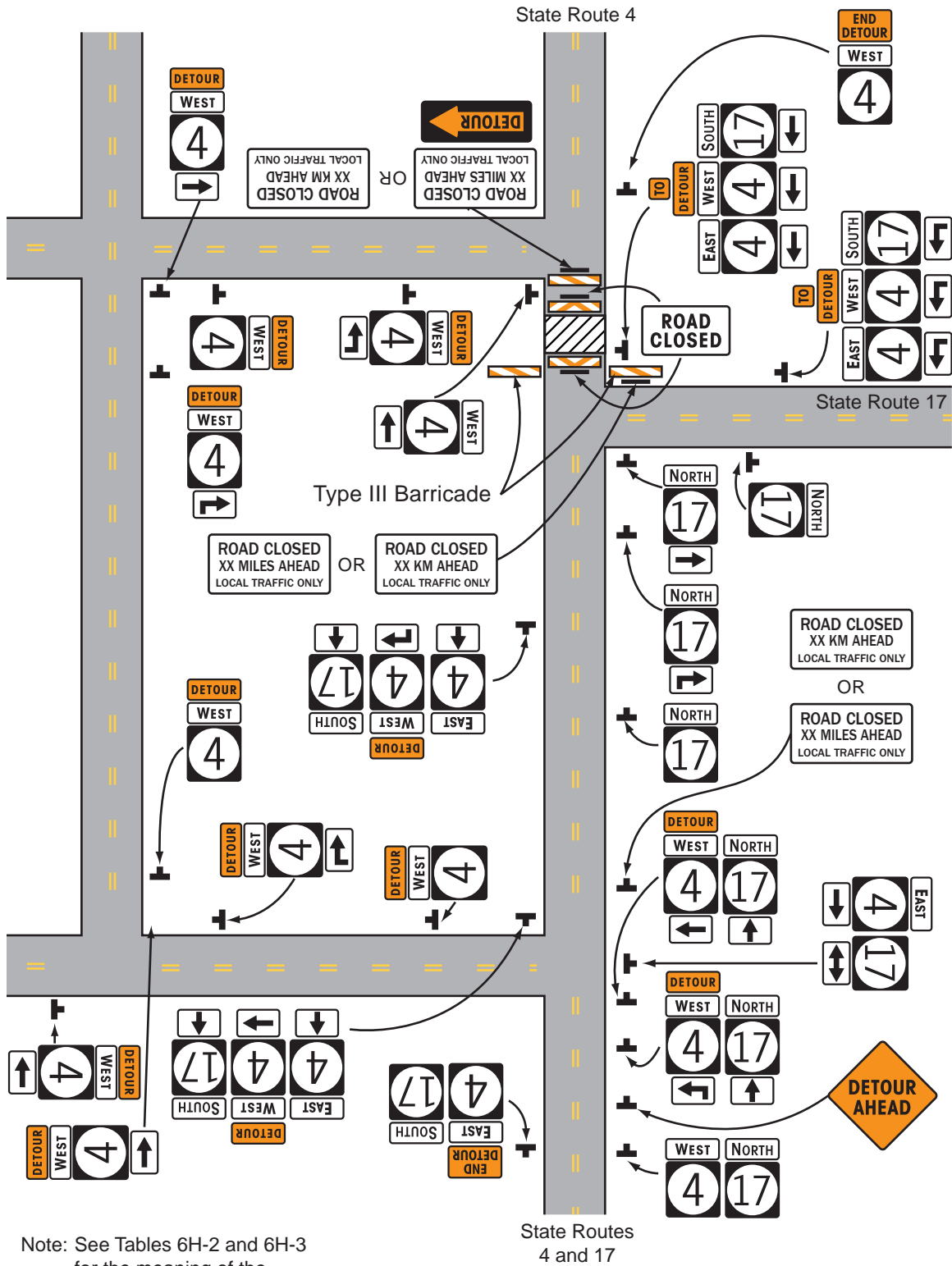

Note: See Tables 6H-2 and 6H-3 for the meaning of the symbols and/or letter codes used in this figure.

Typical Application 9

Notes for Figure 6H-10 – Typical Application 10

Lane Closure on Two-Lane Road Using Flaggers

Option:

1. For low-volume situations with short work zones on straight roadways where the flagger is visible to road users approaching from both directions, a single flagger, positioned to be visible to road users approaching from both directions, may be used (see Chapter 6E).
2. The ROAD WORK AHEAD and the END ROAD WORK signs may be omitted for short-duration operations.
3. Flashing warning lights and/or flags may be used to call attention to the advance warning signs. A BE PREPARED TO STOP sign may be added to the sign series.
4. A flagger or a law enforcement officer may be used at the highway-rail grade crossing to minimize the probability that vehicles are stopped within 4.5 m (15 ft) of the highway-rail grade crossing, measured from both sides of the outside rails.

Guidance:

5. Channelizing devices should be extended to a point where they are visible to approaching road users.
6. Floodlights should be provided as needed to mark flagger stations at night.
7. When used, the BE PREPARED TO STOP sign should be located between the Advance Flagger sign and the ONE LANE ROAD sign.
8. When a highway-rail grade crossing exists within or upstream of the transition area and it is anticipated that backups resulting from the lane closure might extend through the highway-rail grade crossing, the temporary traffic control zone should be extended so that the transition area precedes the highway-rail grade crossing.
9. When a highway-rail grade crossing equipped with active warning devices exists within the activity area, provisions should be made for keeping flaggers informed as to the activation status of these warning devices.
10. When a highway-rail grade crossing exists within the activity area, drivers operating on the left side of the normal centerline should be provided with comparable warning devices as for drivers operating on the right side of the normal centerline.
11. Early coordination with the railroad company should occur before work starts.

Figure 6H-10. Lane Closure on Two-Lane Road Using Flaggers (TA-10)

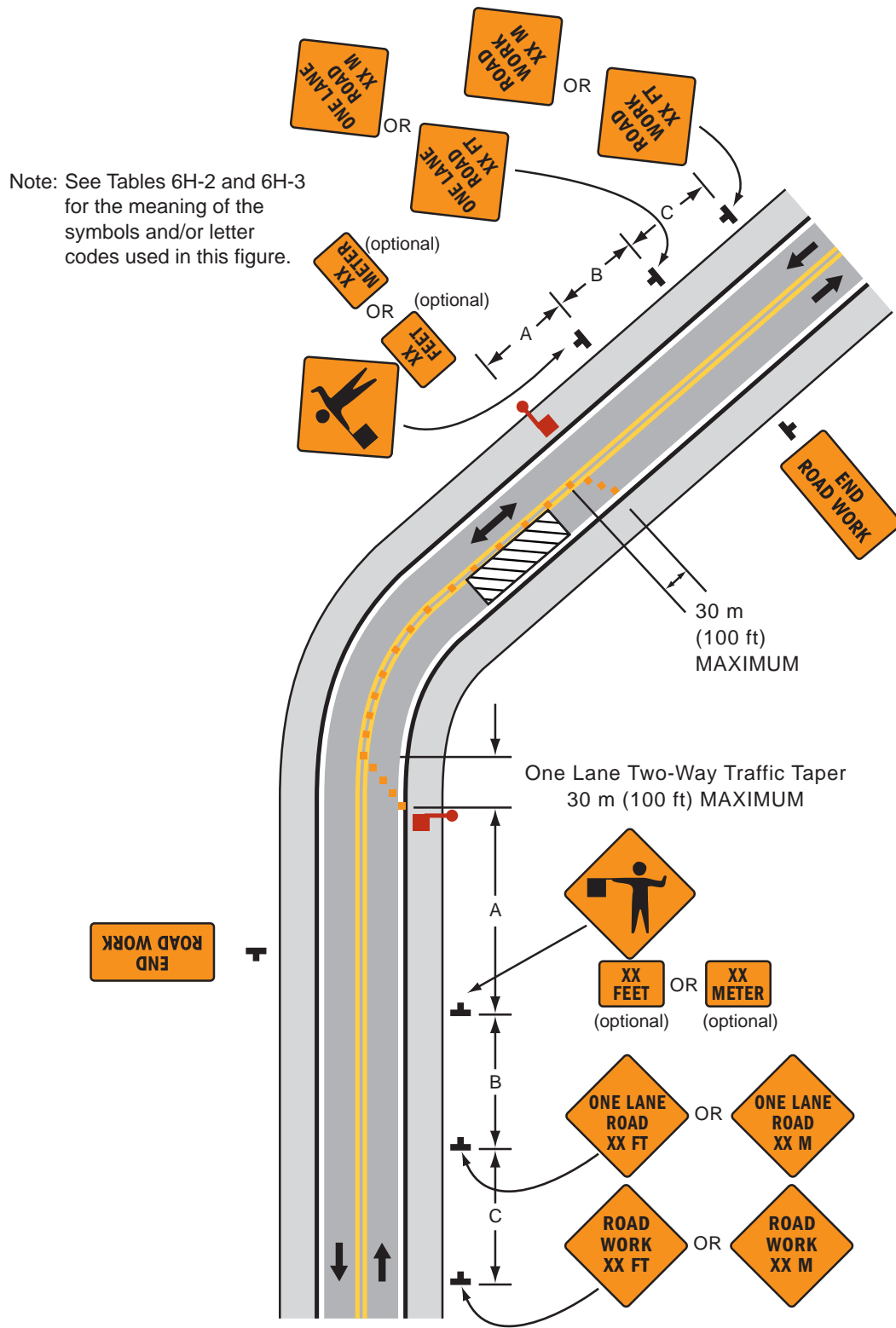

Typical Application 10

Notes for Figure 6H-11 – Typical Application 11

Lane Closure on Low-Volume Two-Lane Road

Option:

1. This temporary traffic control zone application may be used as an alternate temporary traffic control plan to the lane closure with flaggers (Figure 6H-10), when the following conditions exist:
 - a. Motor vehicle traffic volume is such that sufficient gaps exist for motor vehicle traffic that must yield.
 - b. Drivers from both directions are able to see approaching motor vehicle traffic through and beyond the work site.

Standard:

- 2. When flaggers are used, the Flagger symbol sign shall be used in place of the YIELD AHEAD sign.**

Option:

3. The Type B flashing warning lights may be placed on the ROAD WORK AHEAD and the ONE LANE ROAD AHEAD signs whenever a night lane closure is necessary.

Figure 6H-11. Lane Closure on Low-Volume Two-Lane Road (TA-11)

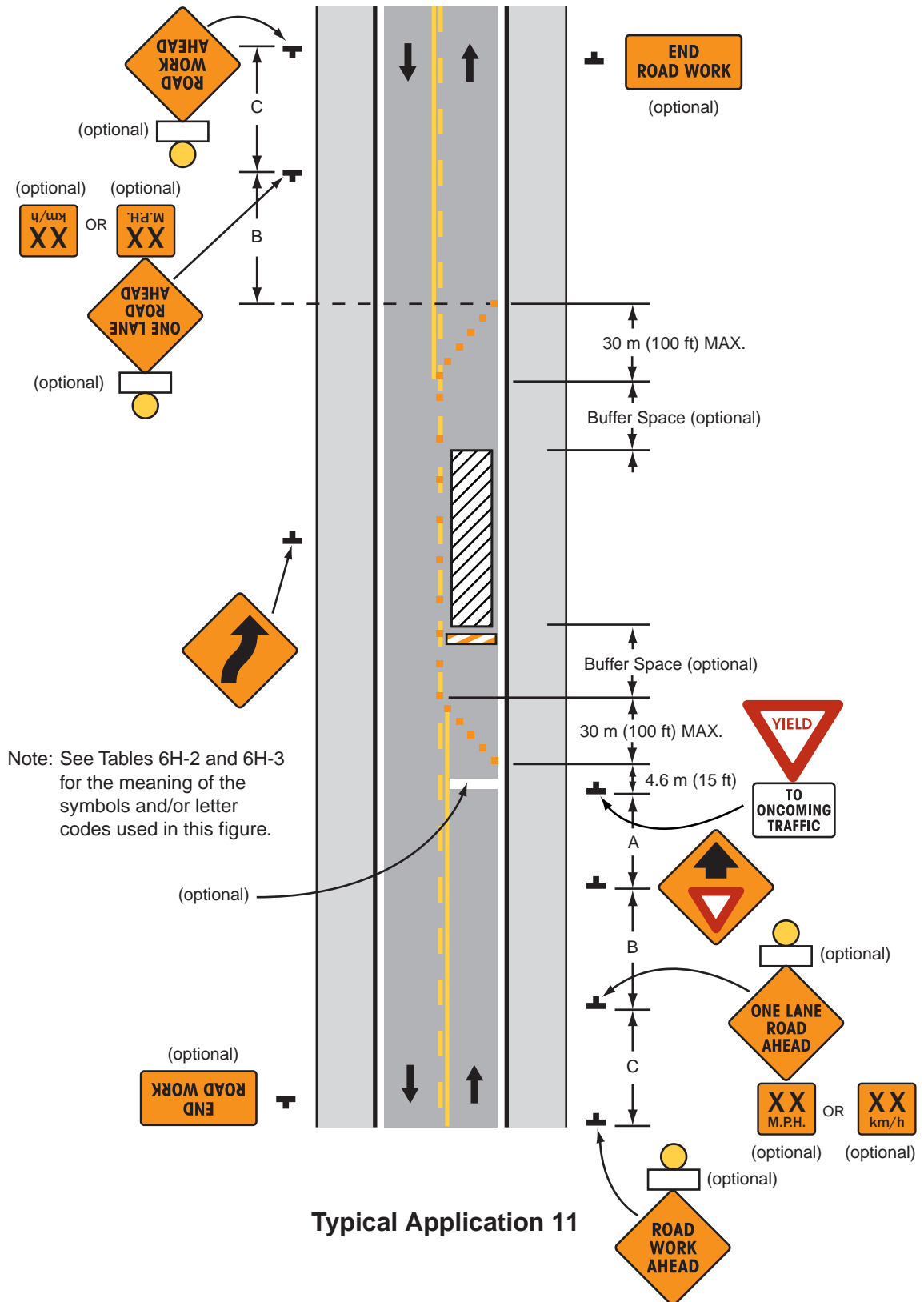

Notes for Figure 6H-12 – Typical Application 12

Lane Closure on Two-Lane Road Using Traffic Control Signals

Standard:

1. **Temporary traffic control signals shall be installed and operated in accordance with the provisions of Part 4. Temporary traffic control signals shall meet the physical display and operational requirements of conventional traffic control signals.**
2. **Temporary traffic control signal timing shall be established by qualified officials.**
3. **When the temporary traffic control signal is changed to the flashing mode, either manually or automatically, red signal indications shall be flashed to both approaches.**
4. **Stop lines shall be installed with temporary traffic control signals. Existing conflicting pavement markings and raised pavement marker reflectors between the activity area and the stop line shall be removed. After the temporary traffic control signal is removed, the stop lines and other temporary pavement markings shall be removed and the permanent pavement markings restored.**

Guidance:

5. Where no-passing lines are not already in place, they should be added.
6. Adjustments in the location of the advance warning signs should be made as needed to accommodate the horizontal or vertical alignment of the roadway recognizing that the distances shown for sign spacings are minimums. Adjustments in the height of the signal heads should be made as needed to conform to the vertical alignment.

Option:

7. Flashing warning lights shown on the ROAD WORK AHEAD and the ONE LANE ROAD AHEAD signs may be used.
8. Removable pavement markings may be used.

Support:

9. Temporary traffic control signals are preferable to flaggers for long-term projects and other activities that would require flagging at night.
10. The maximum length of activity area for one-way operation under temporary traffic control signal control is determined by the capacity required to handle the peak demand.

Figure 6H-12. Lane Closure on Two-Lane Road Using Traffic Control Signals (TA-12)

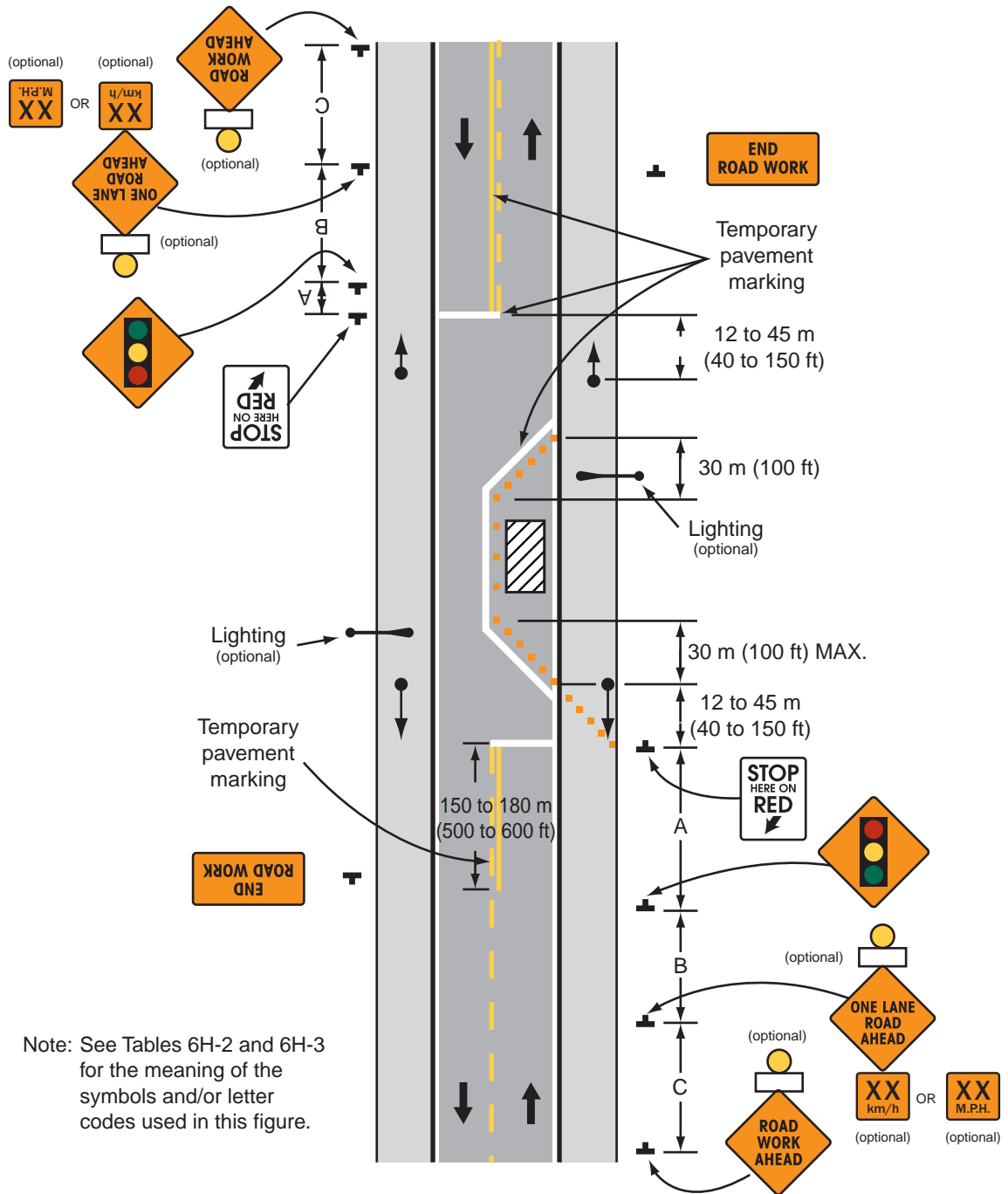

Note: See Tables 6H-2 and 6H-3 for the meaning of the symbols and/or letter codes used in this figure.

Typical Application 12

Notes for Figure 6H-13 – Typical Application 13

Temporary Road Closure

Support:

1. Conditions represented are a planned closure not exceeding 20 minutes during the daytime.

Standard:

- 2. The flagger shall follow the procedures noted in Sections 6E.04 and 6E.05.**

Option:

3. A law enforcement officer and/or a changeable message sign may be used.
4. A BE PREPARED TO STOP sign may be added to the sign series.

Guidance:

5. When used, the PREPARED TO STOP sign should be located before the Flagger symbol sign.

Figure 6H-13. Temporary Road Closure (TA-13)

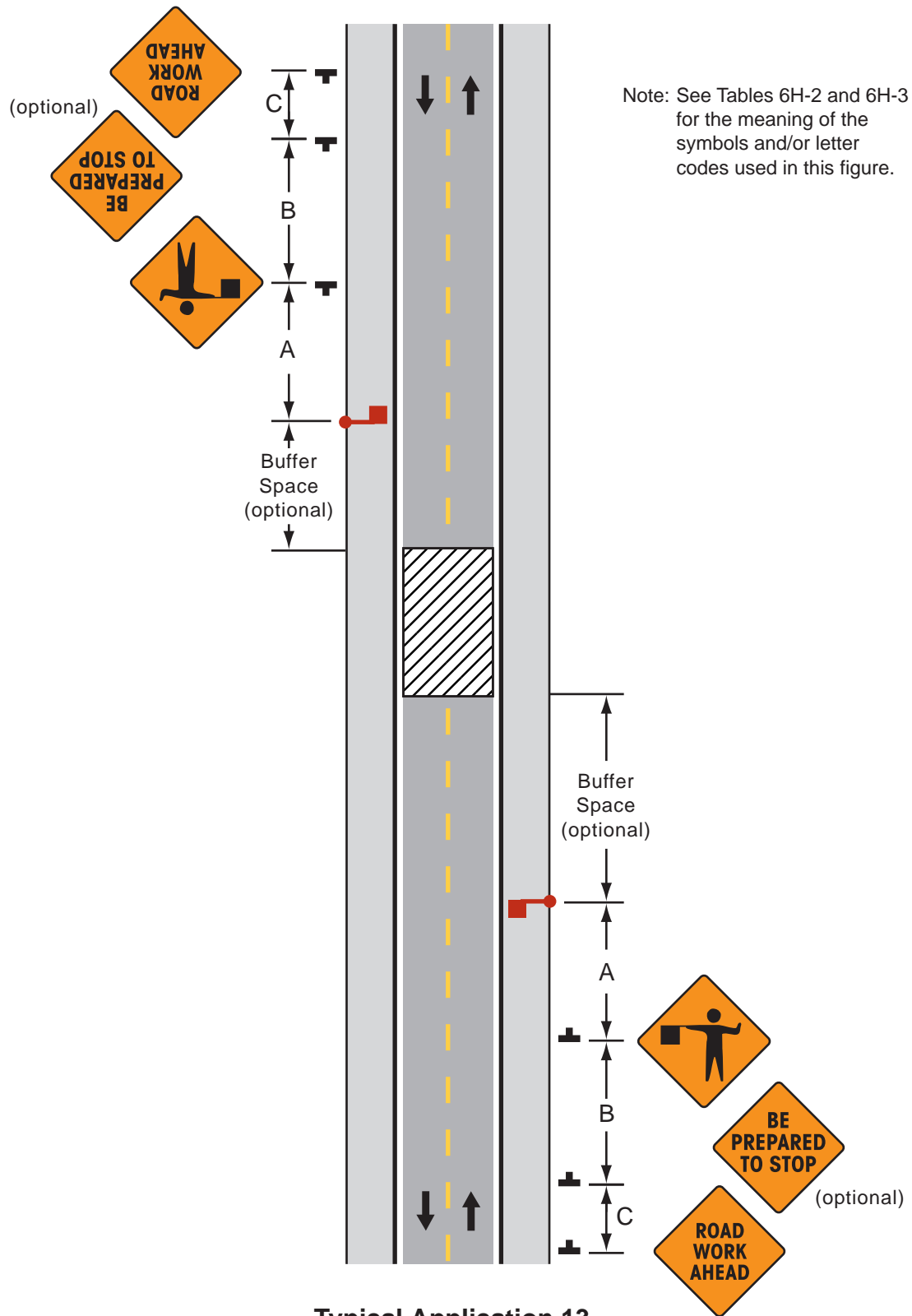

Typical Application 13

Notes for Figure 6H-14 – Typical Application 14

Haul Road Crossing

Guidance:

1. Floodlights should be used to illuminate haul road crossings where existing light is inadequate.
2. Where no passing lines are not already in place, they should be added.

Standard:

3. The traffic control method selected shall be used in both directions.

Flagging Method

4. When a road used exclusively as a haul road is not in use, Type III barricades shall be in place and the Flagger symbol signs covered.
5. The flagger shall follow the procedures noted in Sections 6E.04 and 6E.05.

Signalized Method

6. When a road used exclusively as a haul road is not in use, Type III barricades shall be in place. The signals shall either flash yellow on the main road or be covered, and the Signal Ahead and STOP HERE ON RED signs shall be covered or hidden from view.
7. The temporary traffic control signals shall control both the highway and the haul road and shall meet the physical display and operational requirements of conventional traffic control signals as described in Part 4. Traffic control signal timing shall be established by authorized officials.
8. Stop lines shall be used on existing highway with temporary traffic control signals.
9. Existing conflicting pavements markings between the stop lines shall be removed. After the temporary traffic control signal is removed, the stop lines and other temporary pavement markings shall be removed and the permanent pavement markings restored.

Notes for Figure 6H-15 – Typical Application 15

Work in Center of Low-Volume Road

Guidance:

1. The lanes on either side of the center work space should have a minimum width of 3 m (10 ft) as measured from the near edge of the channelizing devices to the edge of pavement or the outside edge of paved shoulder.

Option:

2. Flashing warning lights and/or flags may be used to call attention to the advance warning signs.
3. If the closure continues overnight, warning lights may be used on the channelizing devices.
4. A lane width of 2.7 m (9 ft) may be used for short-term stationary work on low-volume, low-speed roadways when motor vehicle traffic does not include longer and wider heavy commercial vehicles.
5. A work vehicle displaying rotating lights or strobe lights may be used instead of the channelizing devices forming the tapers or the high-level warning devices.

Standard:

- 6. Although vehicle hazard warning signals can be used to supplement the rotating lights or strobe lights, they shall not be used instead of rotating lights or strobe lights.**

Figure 6H-15. Work in Center of Low-Volume Road (TA-15)

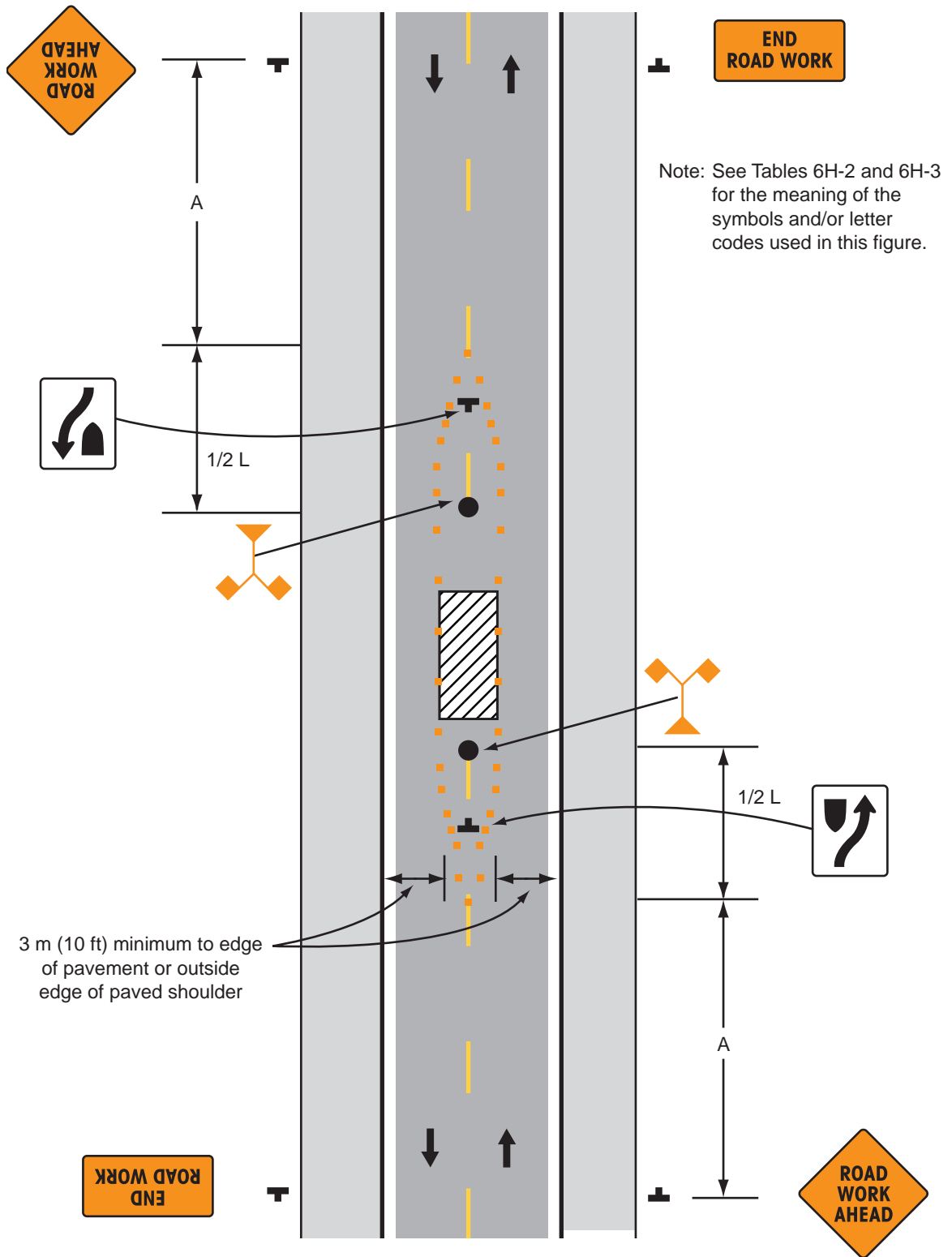

Typical Application 15

Notes for Figure 6H-16 – Typical Application 16
Surveying Along Centerline of Low-Volume Road

Guidance:

1. Cones should be placed 150 mm (6 in) to 300 mm (12 in) on either side of the centerline.
2. When using metric units, spacing of channelizing devices should not exceed a distance in meters equal to 1/5 of the speed limit (km/h) when used for taper channelization and a distance in meters equal to 2/5 of the speed limit (km/h) when used for tangent channelization. When using English units, spacing of channelizing devices should not exceed a distance in feet equal to the speed limit (mph) when used for the taper channelization and a distance in feet of 2 times the speed limit (mph) when used for tangent channelization.
3. A flagger should be used to warn workers who cannot watch road users.
4. Workers in the roadway should wear high-visibility clothing.

Standard:

- 5. For surveying on the centerline of a high-volume road, one lane shall be closed using the information illustrated in Figure 6H-10.**

Option:

6. A high-level warning device may be used to protect a surveying device, such as a target on a tripod.
7. Cones may be omitted for a cross-section survey.
8. ROAD WORK AHEAD signs may be used in place of the SURVEY CREW AHEAD signs.
9. Flags may be used to call attention to the advance warning signs.
10. If the work is along the shoulder, the flagger may be omitted.
11. For a survey along the edge of the road or along the shoulder, cones may be placed along the edge line.
12. A BE PREPARED TO STOP sign may be added to the sign series.

Guidance:

13. When used, the BE PREPARED TO STOP sign should be located before the Flagger symbol sign.

Figure 6H-16. Surveying Along Centerline of Low-Volume Road (TA-16)

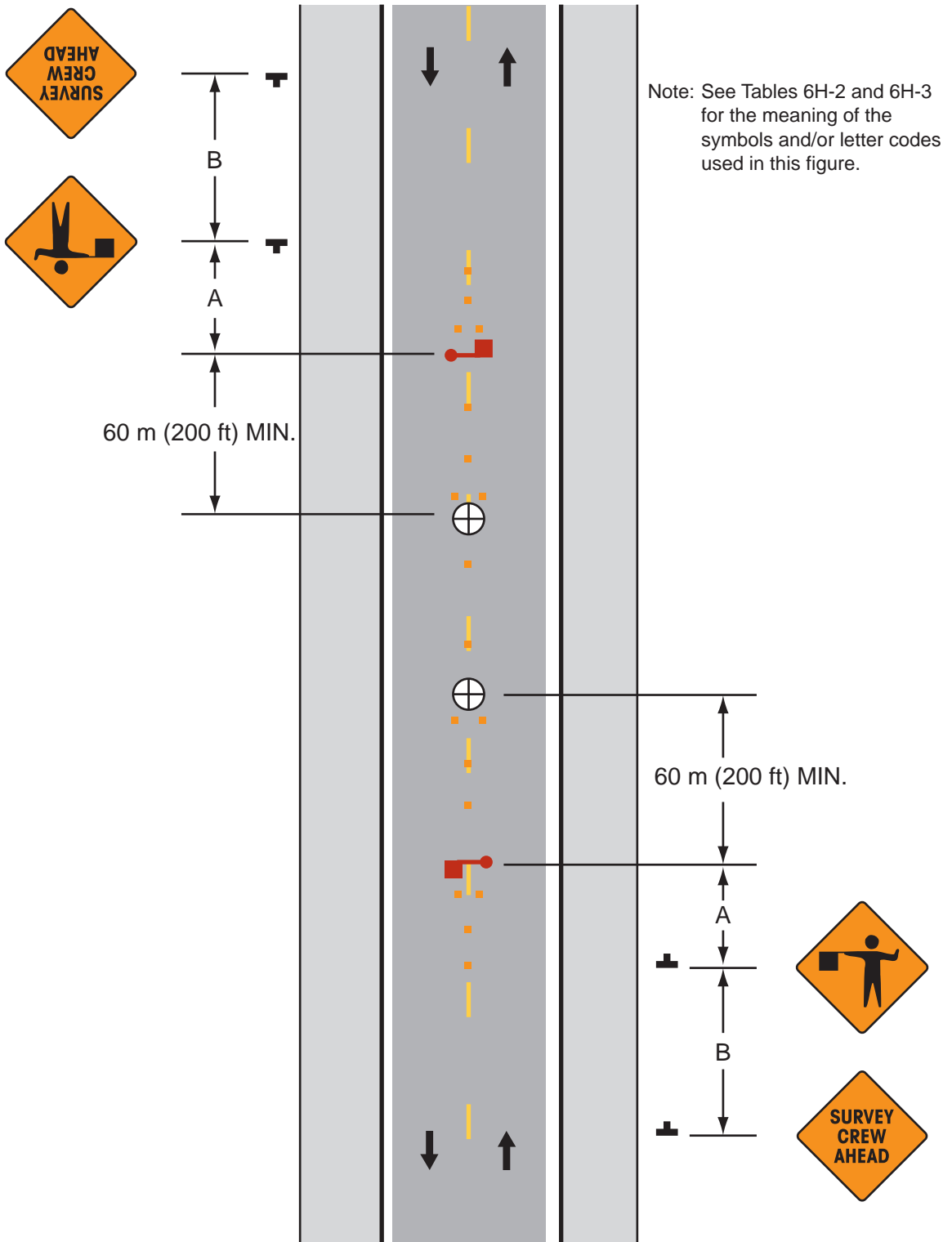

Typical Application 16

Notes for Figure 6H-17 – Typical Application 17

Mobile Operations on Two-Lane Road

Standard:

1. **Vehicle-mounted signs shall be mounted with the bottom of the sign at a minimum height of 1,200 mm (48 in) above the pavement. Sign legends shall be covered or turned from view when work is not in progress.**
2. **Shadow and work vehicles shall display rotating lights or strobe lights.**

Guidance:

3. Where practical and when needed, the work and shadow vehicles should pull over periodically to allow motor vehicle traffic to pass.
4. Whenever adequate stopping sight distance exists to the rear, the shadow vehicle should maintain the minimum distance from the work vehicle and proceed at the same speed. The shadow vehicle should slow down in advance of vertical or horizontal curves that restrict sight distance.
5. A truck-mounted attenuator should be used on the shadow vehicle.
6. The shadow vehicles should also be equipped with two high-intensity flashing lights mounted on the rear, adjacent to the sign.

Option:

7. The distance between the work and shadow vehicles may vary according to terrain, paint drying time, and other factors.
8. Additional shadow vehicles to warn and reduce the speed of oncoming or opposing motor vehicle traffic may be used. Police patrol cars may be used for this purpose.
9. A truck-mounted attenuator may be used on the work vehicle.
10. If the work and shadow vehicles cannot pull over to allow motor vehicle traffic to pass frequently, a DO NOT PASS sign may be placed on the rear of the vehicle blocking the lane.

Support:

11. Shadow vehicles are used to warn motor vehicle traffic of the operation ahead.

Figure 6H-17. Mobile Operations on Two-Lane Road (TA-17)

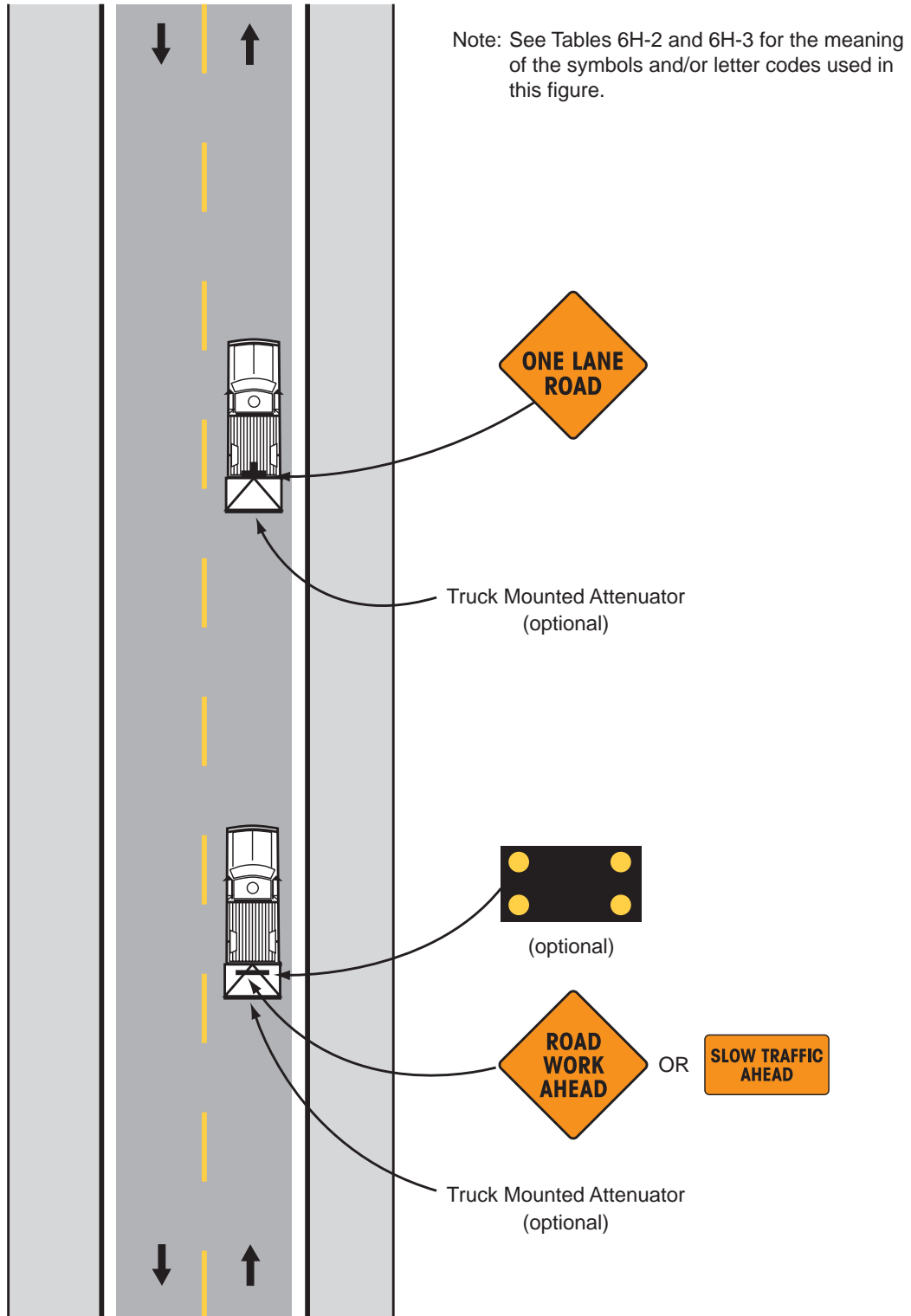

Typical Application 17

Notes for Figure 6H-18 – Typical Application 18

Lane Closure on Minor Street

Standard:

- 1. This temporary traffic control shall be used only for low-volume, low-speed facilities.**

Option:

2. Where the work space is short, where drivers can see the roadway beyond, and where volume is low, motor vehicle traffic may be self-regulating.

Standard:

- 3. Where motor vehicle traffic cannot effectively self-regulate, one or two flaggers shall be used as illustrated in Figure 6H-10.**

Option:

4. Flashing warning lights and/or flags may be used to call attention to the advance warning signs.
5. A truck-mounted attenuator may be used on the work vehicle and the shadow vehicle.

Figure 6H-18. Lane Closure on Minor Street (TA-18)

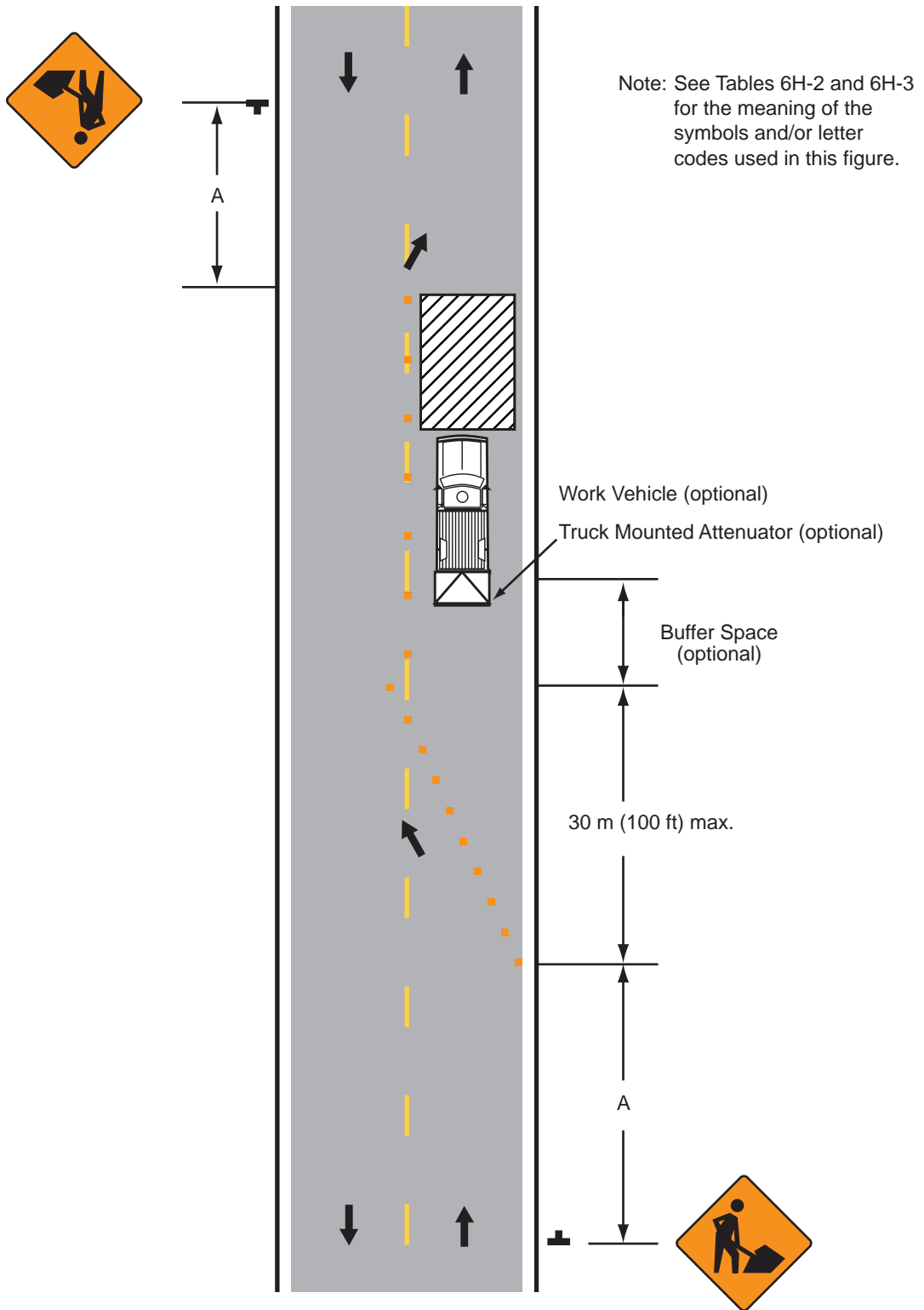

Typical Application 18

Notes for Figure 6H-19 – Typical Application 19

Detour for One Travel Direction

Option:

1. The STREET CLOSED legend may be used in place of ROAD CLOSED.
2. Additional DO NOT ENTER signs may be used at intersections with intervening streets.
3. Warning lights may be used on Type III Barricades.
4. Detour signs may be located on the far side of intersections.
5. A Street Name sign may be mounted with the Detour sign. The Street Name sign may be either white on green or black on orange.

Standard:

- 6. When used, the Street Name sign shall be placed above the Detour sign.**

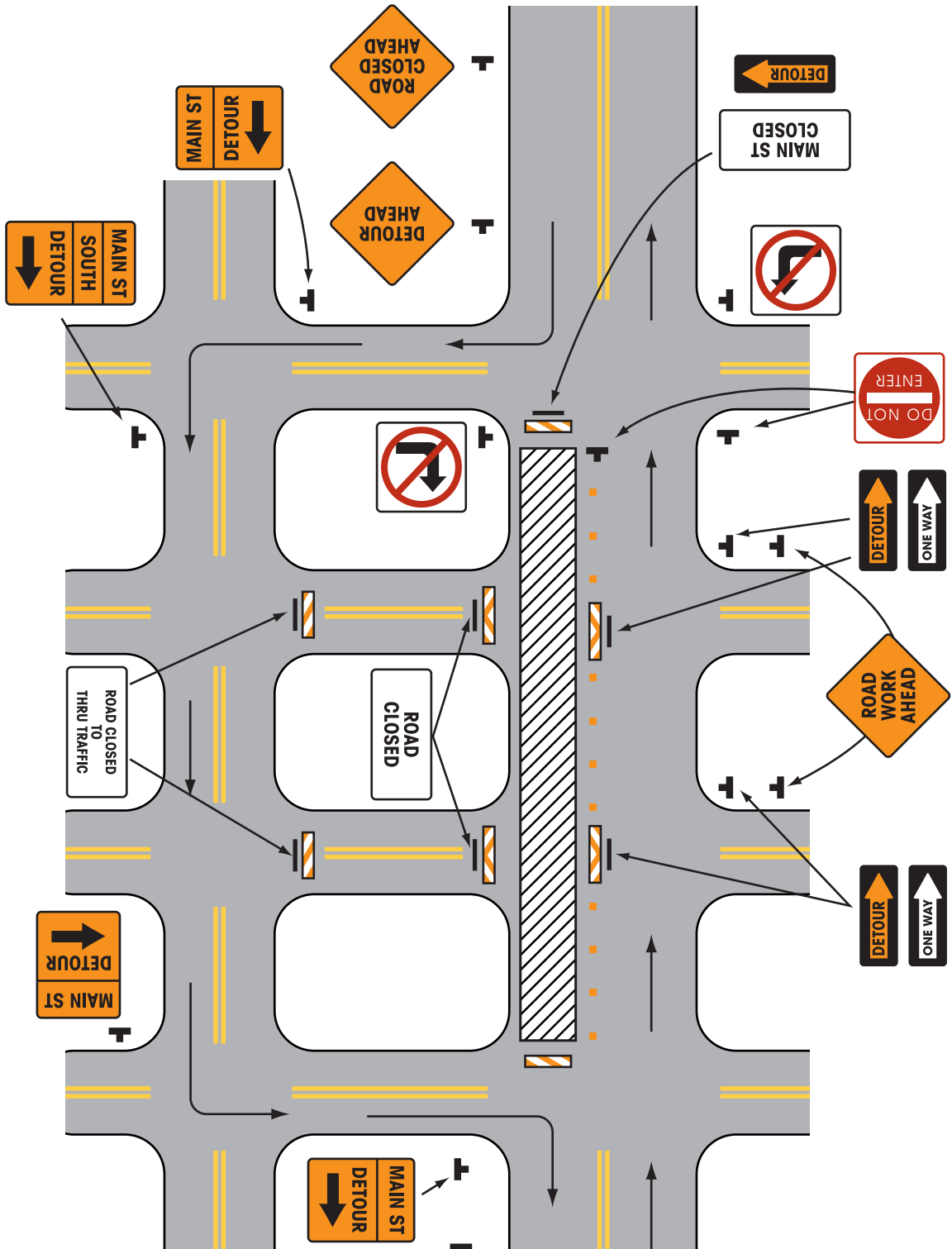

See Tables 6H-2 and 6H-3 for the meaning of the symbols and/or letter codes used in this figure.

Typical Application 19

Notes for Figure 6H-20 – Typical Application 20

Detour for Closed Street

Guidance:

1. This plan should be used for streets without posted route numbers.
2. On multi-lane streets, Detour signs with an Advance Turn Arrow should be used in advance of a turn.

Option:

3. Flashing warning lights and/or flags may be used to call attention to the advance warning signs.
4. Flashing warning lights may be used on Type III Barricades.
5. Detour signs may be located on the far side of intersections. A Detour sign with an advance arrow may be used in advance of a turn.
6. A Street Name sign may be mounted with the Detour sign. The Street Name sign may be either white on green or black on orange.

Standard:

- 7. When used, the Street Name sign shall be placed above the Detour sign.**

Support:

8. See Figure 6H-9 for the information for detouring a numbered highway.

Figure 6H-20. Detour for Closed Street (TA-20)

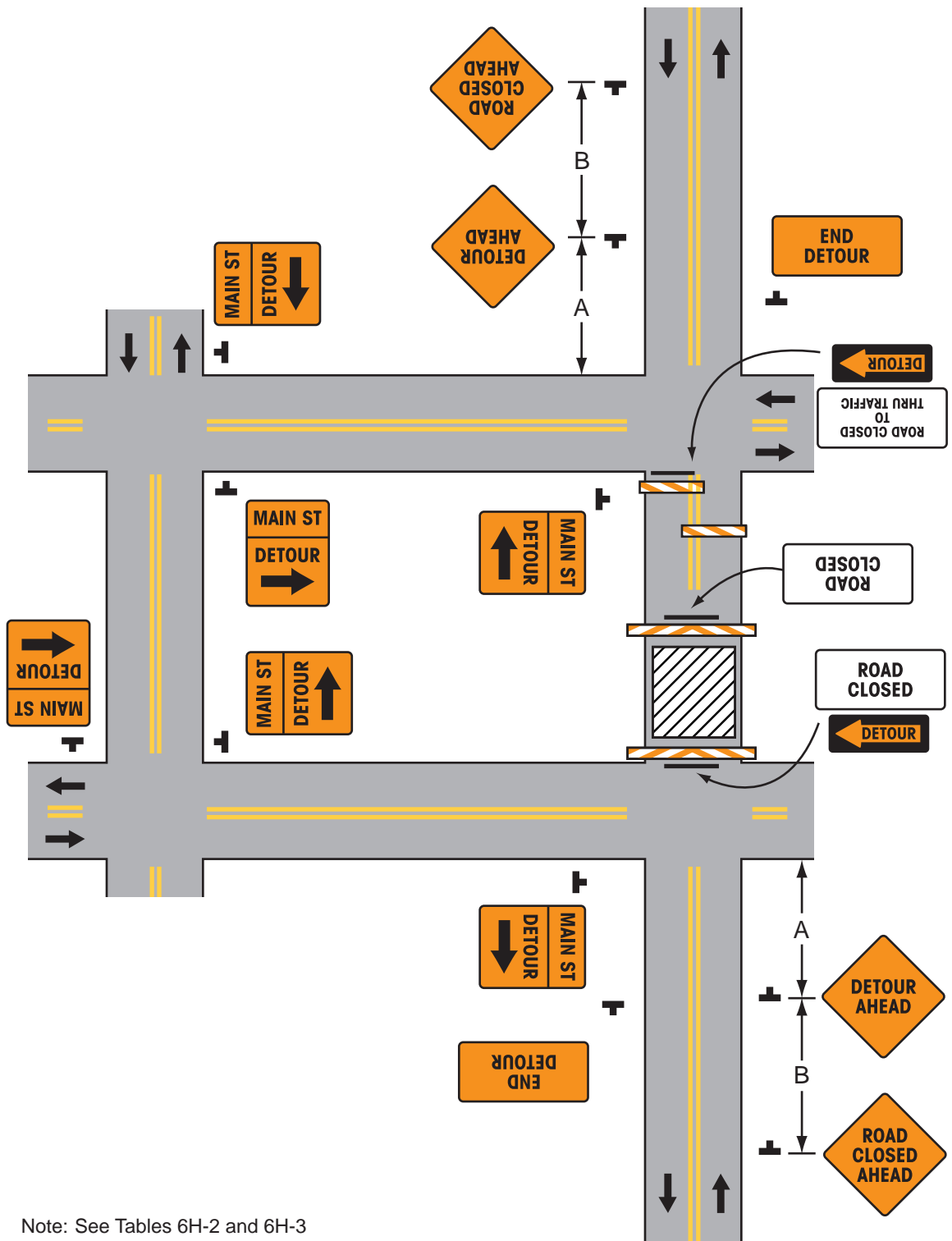

Note: See Tables 6H-2 and 6H-3 for the meaning of the symbols and/or letter codes used in this figure.

Typical Application 20

Notes for Figure 6H-21 – Typical Application 21

Lane Closure on Near Side of Intersection

Standard:

- 1. The merging taper shall direct motor vehicle traffic into either the right or left lane, but not both.**

Guidance:

2. In this typical application, a left taper is used so that right-turn movements will not impede through motor vehicle traffic. However, the reverse should be true for left-turn movements.
3. If the work space extends across the crosswalk, the crosswalk should be closed using the information and devices shown in Figure 6H-29.

Option:

4. Flashing warning lights and/or flags may be used to call attention to the advance warning signs.
5. A shadow vehicle with a truck-mounted attenuator may be used.
6. A work vehicle with rotating lights or strobe lights may be used with the high-level warning device.

Standard:

- 7. Although vehicle hazard warning signals can be used to supplement the rotating lights or strobe lights, they shall not be used instead of rotating lights or strobe lights.**

Figure 6H-21. Lane Closure on Near Side of Intersection (TA-21)

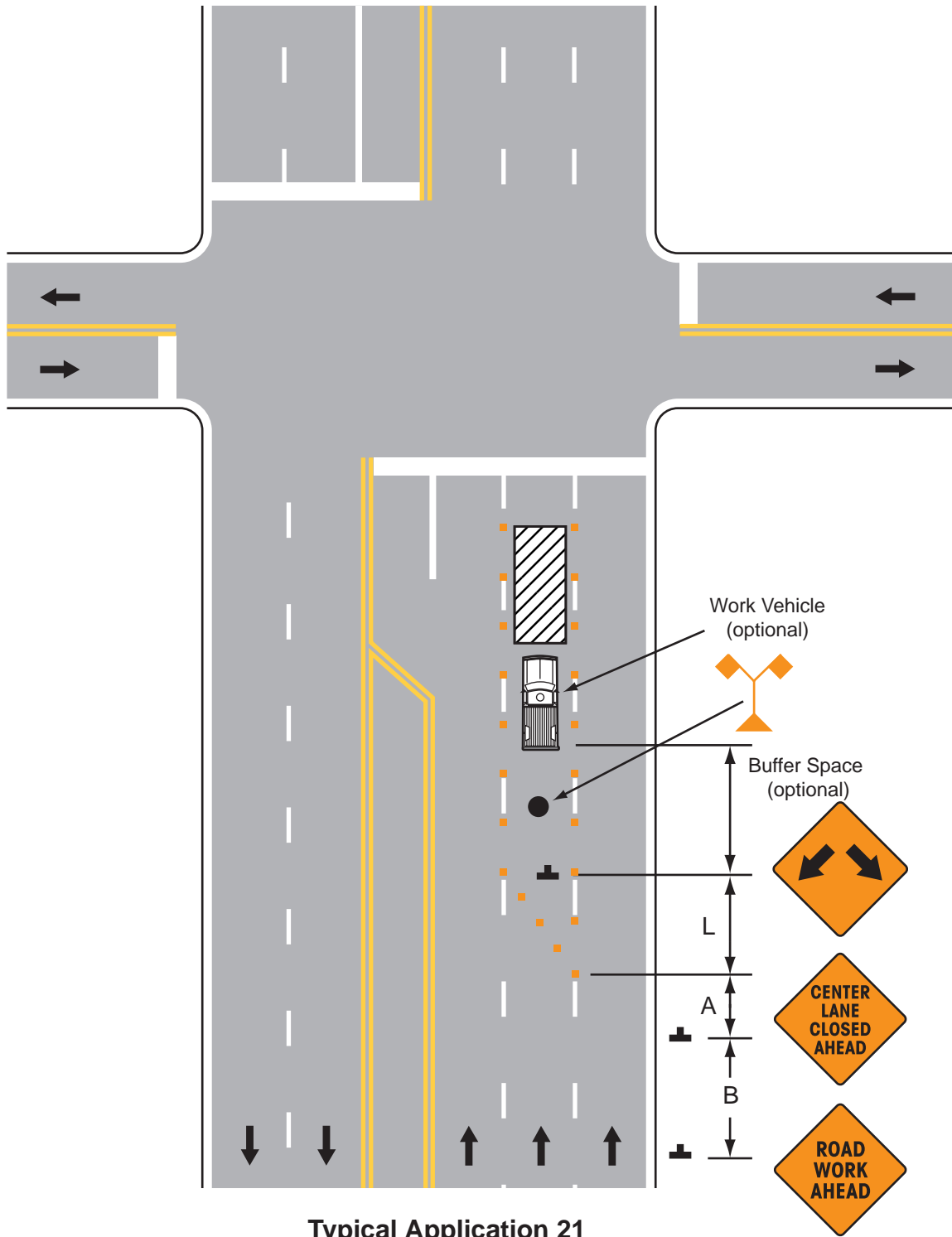

Note: See Tables 6H-2 and 6H-3 for the meaning of the symbols and/or letter codes used in this figure.

Notes for Figure 6H-22 – Typical Application 22

Right Lane Closure on Far Side of Intersection

Guidance:

1. If the work space extends across the crosswalk, the crosswalk should be closed using the information and devices shown in Figure 6H-29.

Option:

2. The normal procedure is to close on the near side of the intersection any lane that is not carried through the intersection. However, when this results in the closure of a right lane having significant right turning movements, then the right lane may be restricted to right turns only, as shown. This procedure increases the through capacity by eliminating right turns from the open through lane.
3. For intersection approaches reduced to a single lane, left-turning movements may be prohibited to maintain capacity for through motor vehicle traffic.
4. Flashing warning lights and/or flags may be used to call attention to the advance warning signs.
5. Where the turning radius is large, it may be possible to create a right-turn island using channelizing devices (see Figure 6H-24).

Notes for Figure 6H-23 – Typical Application 23

Left Lane Closure on Far Side of Intersection

Guidance:

1. If the work space extends across the crosswalk, the crosswalk should be closed using the information and devices shown in Figure 6H-29.

Option:

2. Flashing warning lights and/or flags may be used to call attention to the advance warning signs.
3. The normal procedure is to close on the near side of the intersection any lane that is not carried through the intersection. However, when this results in the closure of a left lane having significant left-turning movements, then the left lane may be converted to a turn bay for left turns only, as shown.

Support:

4. By first closing off the left lane and then reopening it as a turn bay, an island is created with channelizing devices that allows the LEFT LANE MUST TURN LEFT sign to be repeated on the left adjacent to the lane that it controls.

Figure 6H-23. Left Lane Closure on Far Side of Intersection (TA-23)

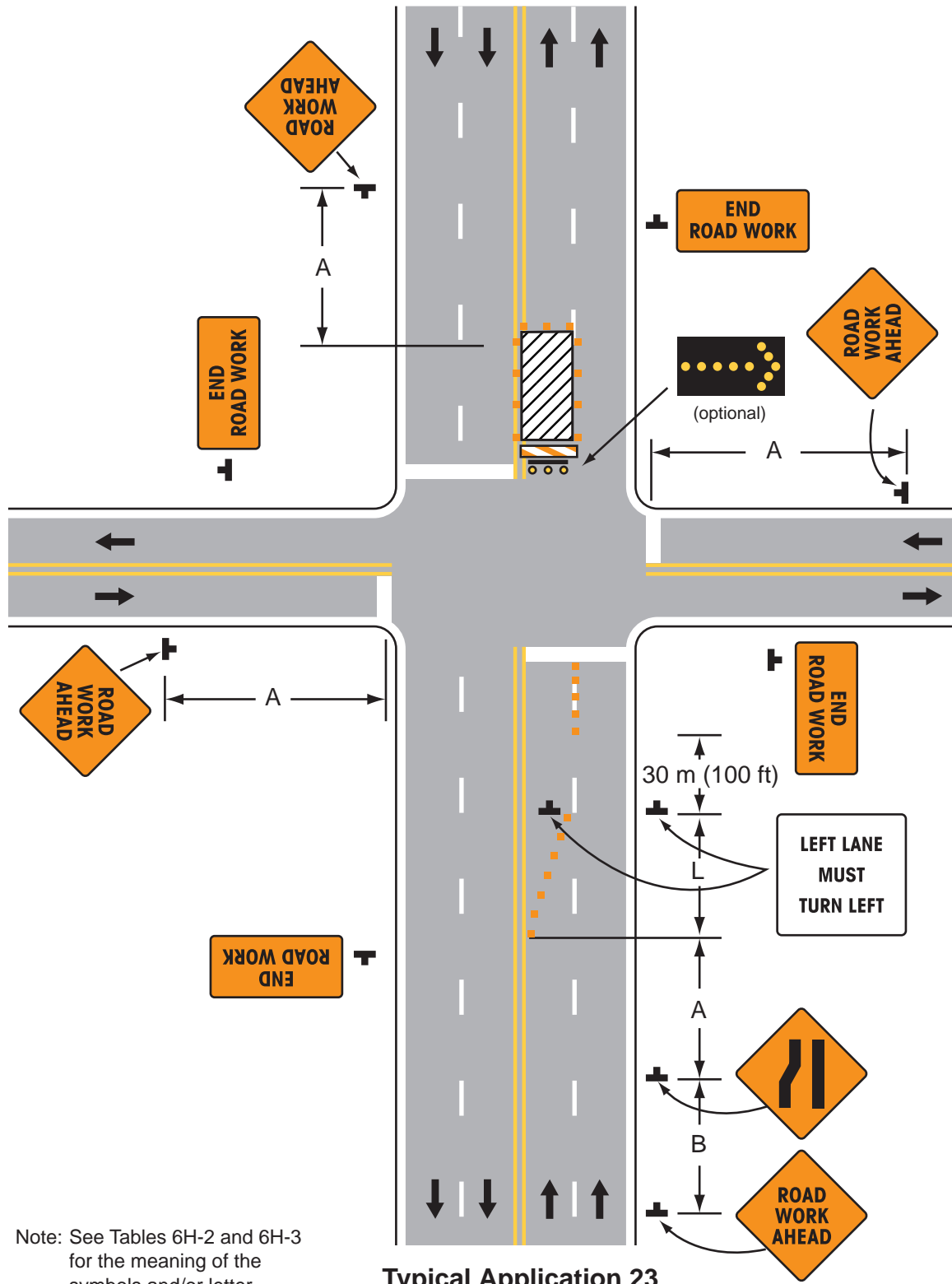

Typical Application 23

Notes for Figure 6H-24 – Typical Application 24

Half Road Closure on Far Side of Intersection

Guidance:

1. If the work space extends across the crosswalk, the crosswalk should be closed using the information and devices shown in Figure 6H-29.
2. When turn prohibitions are implemented, two turn prohibition signs should be used, one on the near side and, space permitting, one on the far side of the intersection.

Option:

3. A buffer space may be used between opposing directions of motor vehicle traffic as shown in this application.
4. The normal procedure is to close on the near side of the intersection any lane that is not carried through the intersection. However, if there is a significant right-turning movement, then the right lane may be restricted to right turns only, as shown.
5. Where the turning radius is large, a right-turn island using channelizing devices or pavement markings may be used, as shown.
6. There may be insufficient space to place the back-to-back Keep Right sign and No Left Turn symbol signs at the end of the row of channelizing devices separating opposing motor vehicle traffic flows. In this situation, the No Left Turn symbol sign may be placed on the right and the Keep Right sign may be omitted.
7. For intersection approaches reduced to a single lane, left-turning movements may be prohibited to maintain capacity for through motor vehicle traffic.
8. Flashing warning lights and/or flags may be used to call attention to advance warning signs.
9. Temporary pavement markings may be used to delineate the travel path through the intersection.

Support:

10. Keeping the right lane open increases the through capacity by eliminating right turns from the open through lane.
11. A temporary turn island reinforces the nature of the temporary exclusive right-turn lane and enables a second RIGHT LANE MUST TURN RIGHT sign to be placed in the island.

Figure 6H-24. Half Road Closure on Far Side of Intersection (TA-24)

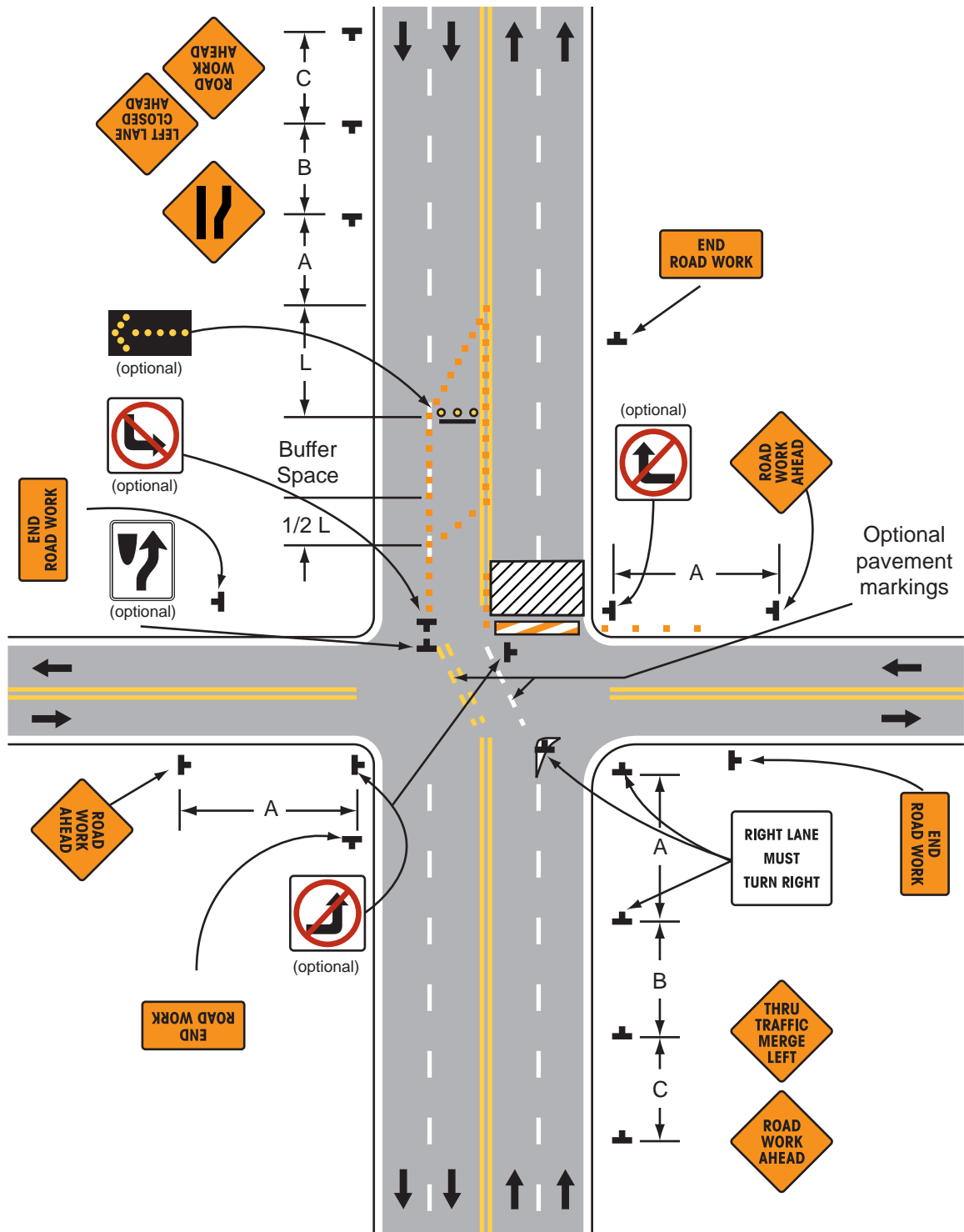

Note: See Tables 6H-2 and 6H-3 for the meaning of the symbols and/or letter codes used in this figure.

Typical Application 24

Notes for Figure 6H-25 – Typical Application 25

Multiple Lane Closures at Intersection

Guidance:

1. If the work space extends across the crosswalk, the crosswalk should be closed using the information and devices shown in Figure 6H-29.
2. If the left through lane is closed on the near-side approach, the **LEFT LANE MUST TURN LEFT** sign should be placed in the median to discourage through motor vehicle traffic from entering the left-turn bay.

Option:

3. The normal procedure is to close on the near side of the intersection any lane that is not carried through the intersection. If the left-turning movement that normally uses the closed turn bay is small and/or the gaps in opposing motor vehicle traffic are frequent, left turns may be permitted on that approach.
4. Flashing warning lights and/or flags may be used to call attention to the advance warning signs.

Figure 6H-25. Multiple Lane Closures at Intersection (TA-25)

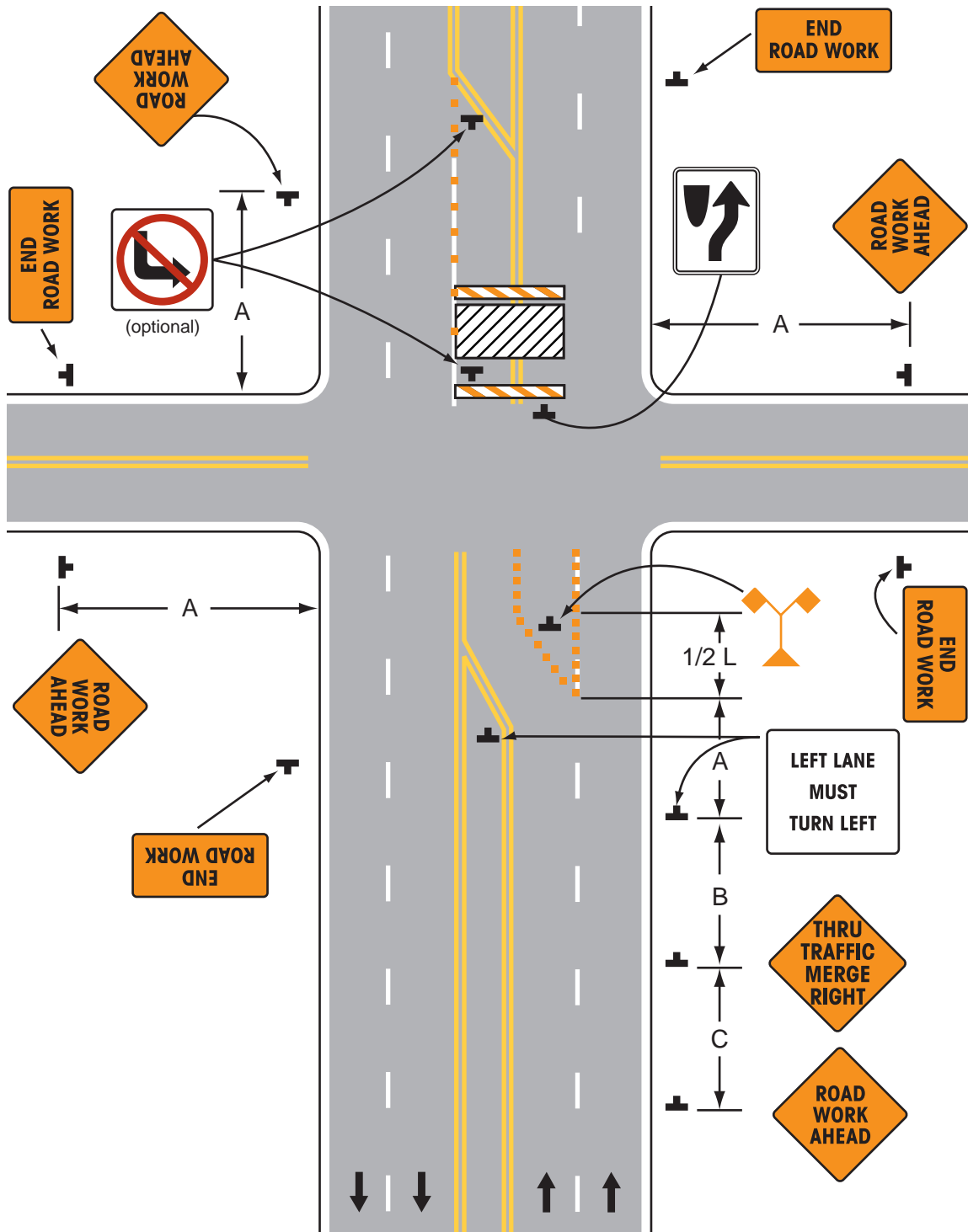

Note: See Tables 6H-2 and 6H-3 for the meaning of the symbols and/or letter codes used in this figure.

Typical Application 25

Notes for Figure 6H-26 – Typical Application 26

Closure in Center of Intersection

Guidance:

1. A high-level warning device should be placed in the work space, if there is sufficient room.
2. All lanes should be a minimum of 3 m (10 ft) in width as measured to the near face of the channelizing devices.

Option:

3. For short-term use on low-volume, low-speed roadways with motor vehicle traffic that does not include longer and wider heavy commercial vehicles, a minimum lane width of 2.7 m (9 ft) may be used.
4. Flashing warning lights and/or flags may be used to call attention to advance warning signs.
5. Unless the streets are wide, it may be physically impossible to turn left, especially for large vehicles. Left turns may be prohibited as required by geometric conditions.
6. For short-duration work operations, the channelizing devices may be eliminated if a vehicle displaying rotating lights or strobe lights is positioned in the work space.

Standard:

- 7. Although vehicle hazard warning signals can be used to supplement the rotating lights or strobe lights, they shall not be used instead of rotating lights or strobe lights.**

Figure 6H-26. Closure in Center of Intersection (TA-26)

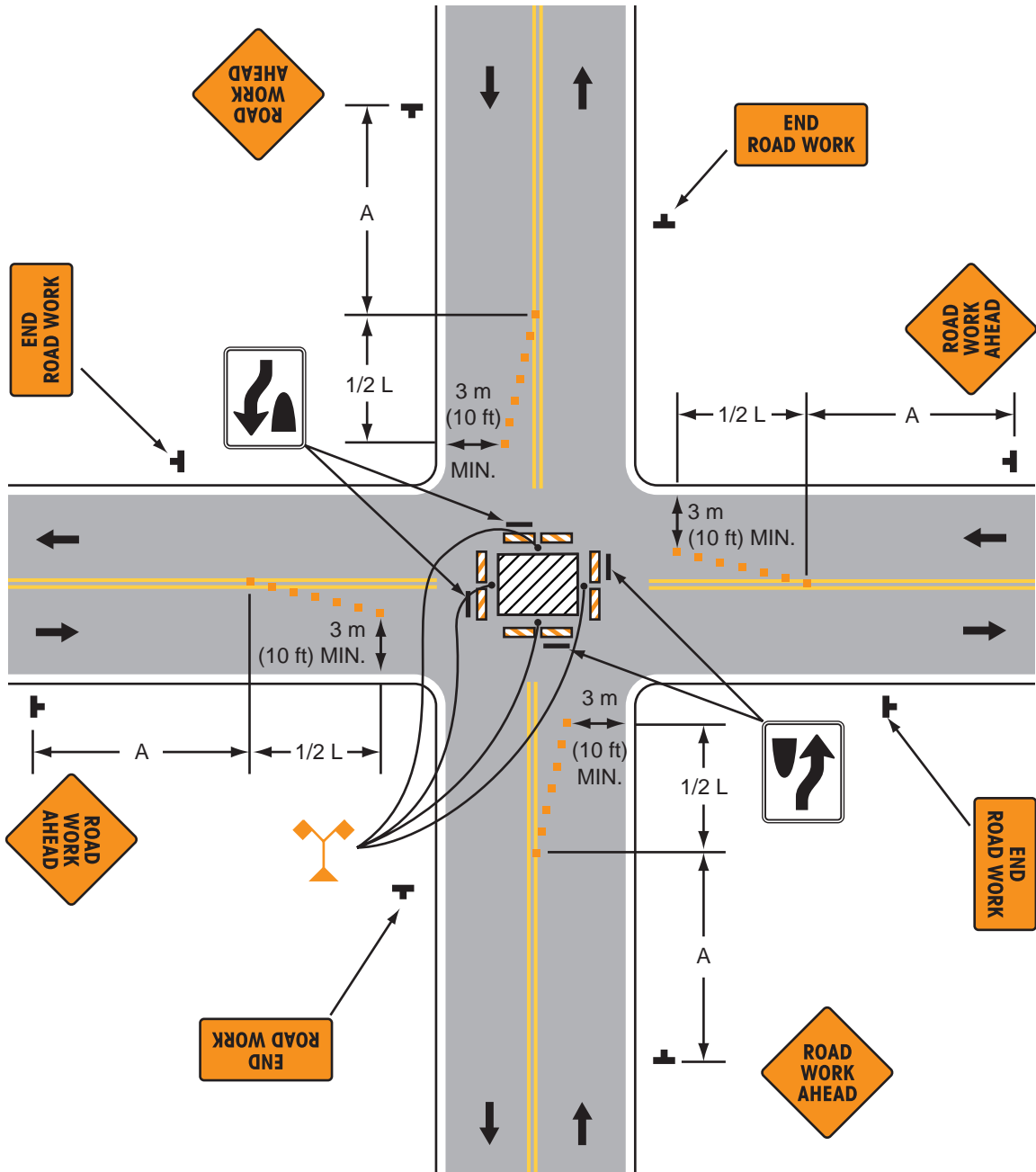

Typical Application 26

Note: See Tables 6H-2 and 6H-3 for the meaning of the symbols and/or letter codes used in this figure.

Notes for Figure 6H-27 – Typical Application 27

Closure at Side of Intersection

Guidance:

1. The situation depicted can be simplified by closing one or more of the intersection approaches. If this cannot be done, and/or when capacity is a problem, through motor vehicle traffic should be directed to other roads or streets.
2. Depending on road user conditions, flagger(s) or uniformed law enforcement officer(s) should be used to direct road users within the intersection.

Option:

3. ONE LANE ROAD AHEAD signs may also be used to provide adequate advance warning.
4. Flashing warning lights and/or flags may be used to call attention to the advance warning signs.
5. For short-duration work operations, the channelizing devices may be eliminated if a vehicle displaying rotating lights or strobe lights is positioned in the work space.
6. A BE PREPARED TO STOP sign may be added to the sign series.

Guidance:

7. When used, the BE PREPARED TO STOP sign should be located before the Flagger symbol sign.

Support:

8. Turns can be prohibited as required by motor vehicle traffic conditions. Unless the streets are wide, it may be physically impossible to make certain turns, especially for large vehicles.

Standard:

- 9. Although vehicle hazard warning signals can be used to supplement the rotating lights or strobe lights, they shall not be used instead of rotating lights or strobe lights.**

Figure 6H-27. Closure at Side of Intersection (TA-27)

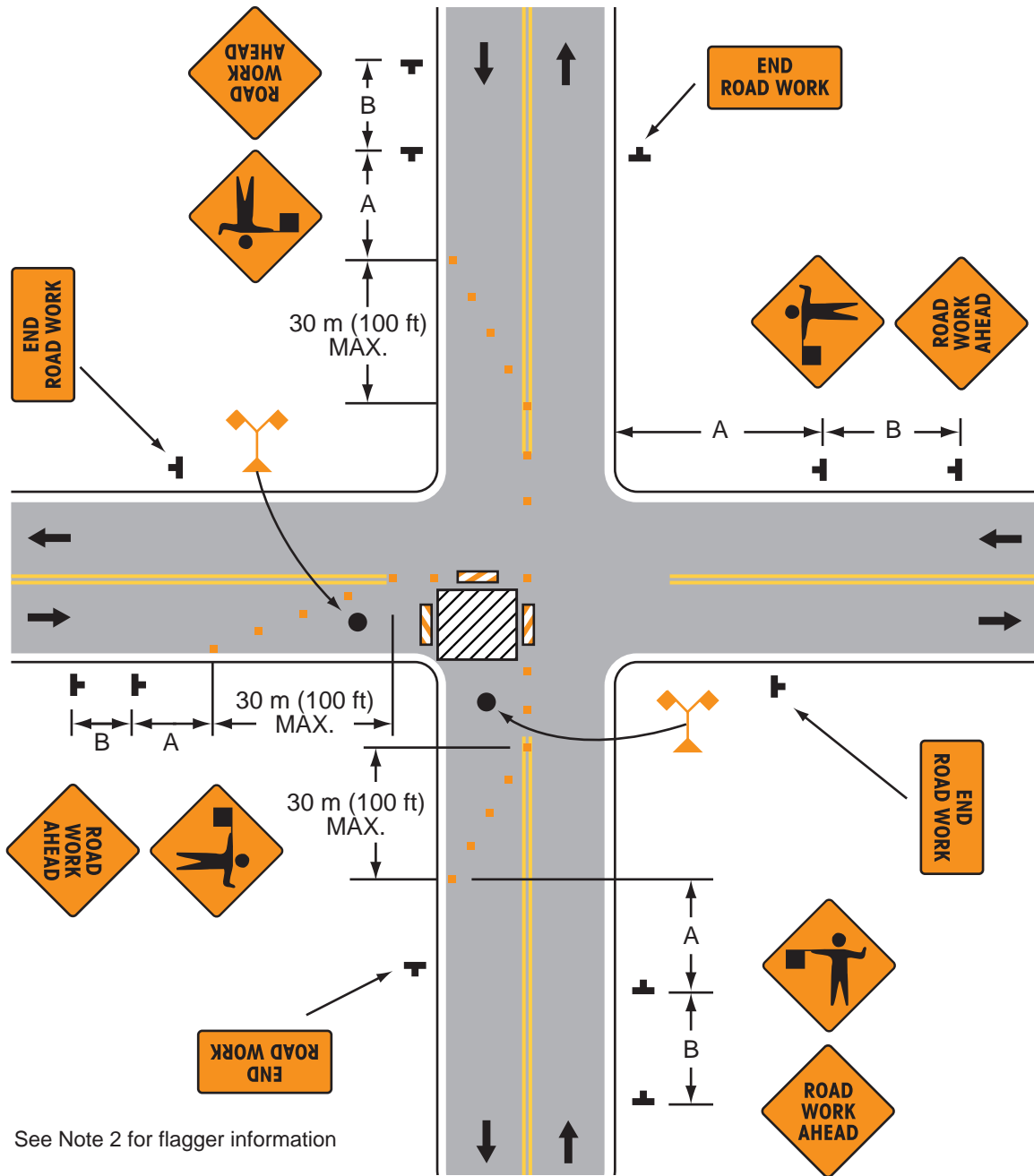

Typical Application 27

Note: See Tables 6H-2 and 6H-3 for the meaning of the symbols and/or letter codes used in this figure.

Notes for Figure 6H-28 – Typical Application 28

Sidewalk Closures and Bypass Sidewalks

Standard:

- 1. Where sidewalks exist, provisions shall be made for disabled pedestrians.**

Guidance:

2. Where high speeds are anticipated, a temporary traffic barrier and, if necessary, a crash cushion should be used to separate the temporary sidewalks from motor vehicle traffic.

Option:

3. Street lighting may be considered.
4. Only the temporary traffic control devices related to pedestrians are shown. Other devices, such as lane closure signing or ROAD NARROWS signs, may be used to control motor vehicle traffic.
5. For nighttime closures, Type A Flashing warning lights may be used on barricades that support signs and close sidewalks.
6. Type C Steady-Burn warning lights may be used on channelizing devices separating the temporary sidewalks from motor vehicle traffic flow.
7. Signs, such as KEEP RIGHT (LEFT), may be placed along a temporary sidewalk to guide or direct pedestrians.

Figure 6H-28. Sidewalk Detour or Diversion (TA-28)

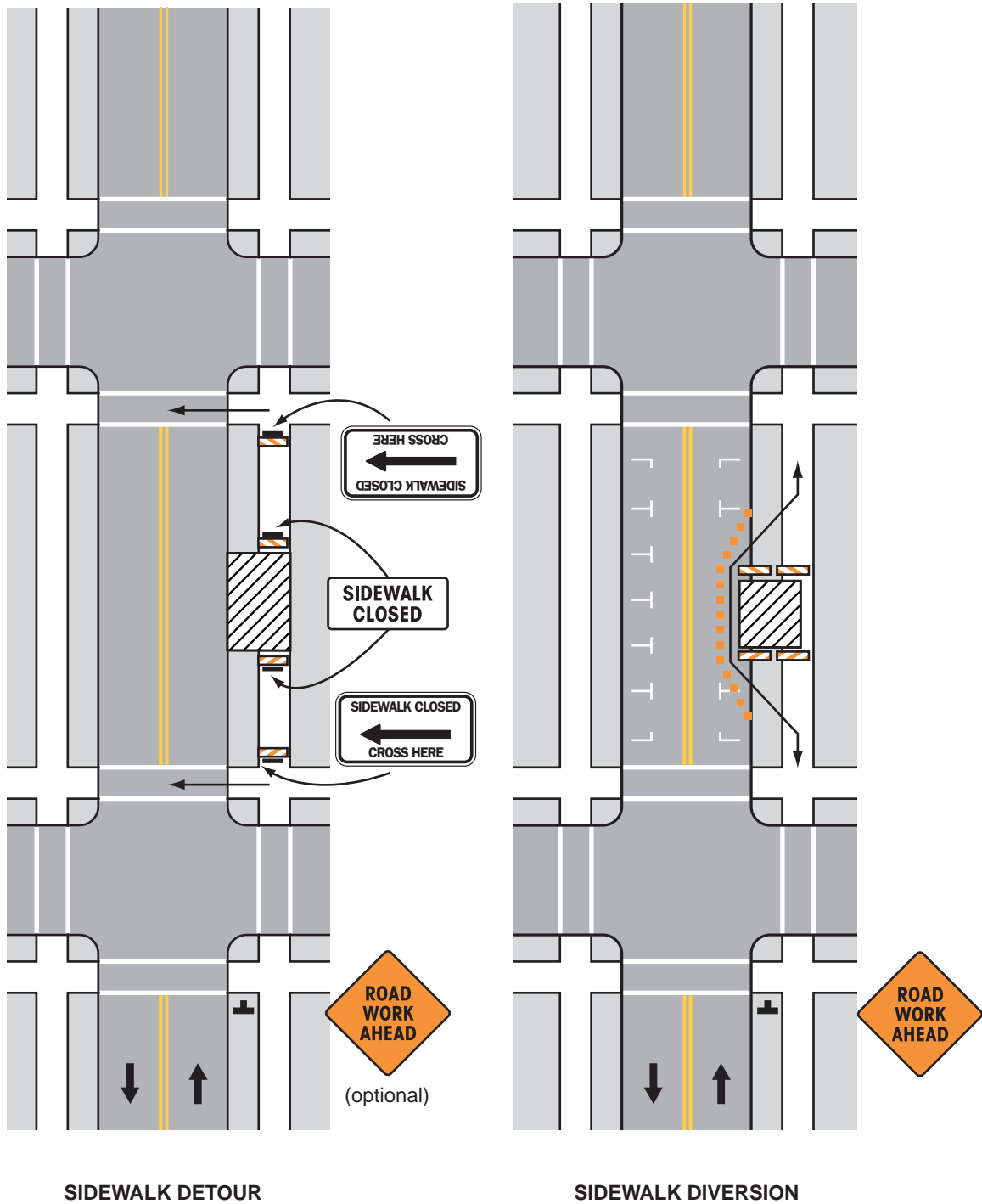

SIDEWALK DETOUR

SIDEWALK DIVERSION

Typical Application 28

Note: See Tables 6H-2 and 6H-3 for the meaning of the symbols and/or letter codes used in this figure.

Notes for Figure 6H-29 – Typical Application 29

Crosswalk Closures and Pedestrian Detours

Standard:

- 1. Where sidewalks exist, provisions shall be made for disabled persons.**
- 2. Curb parking shall be prohibited for at least 15 m (50 ft) in advance of the mid-block crosswalk.**

Guidance:

3. Pedestrian traffic signal displays controlling closed crosswalks should be covered or deactivated.

Option:

4. Street lighting may be considered.
5. Only the temporary traffic control devices related to pedestrians are shown. Other devices, such as lane closure signing or ROAD NARROWS signs, may be used to control motor vehicle traffic.
6. For nighttime closures, Type A Flashing warning lights may be used on barricades supporting signs and closing sidewalks
7. Type C Steady-Burn warning lights may be used on channelizing devices separating the work space from motor vehicle traffic.
8. In order to maintain the systematic use of the fluorescent yellow-green background for pedestrian, bicycle, and school warning signs in a jurisdiction, the fluorescent yellow-green background for pedestrian, bicycle, and school warning signs may be used in temporary traffic control zones.

Figure 6H-29. Crosswalk Closures and Pedestrian Detours (TA-29)

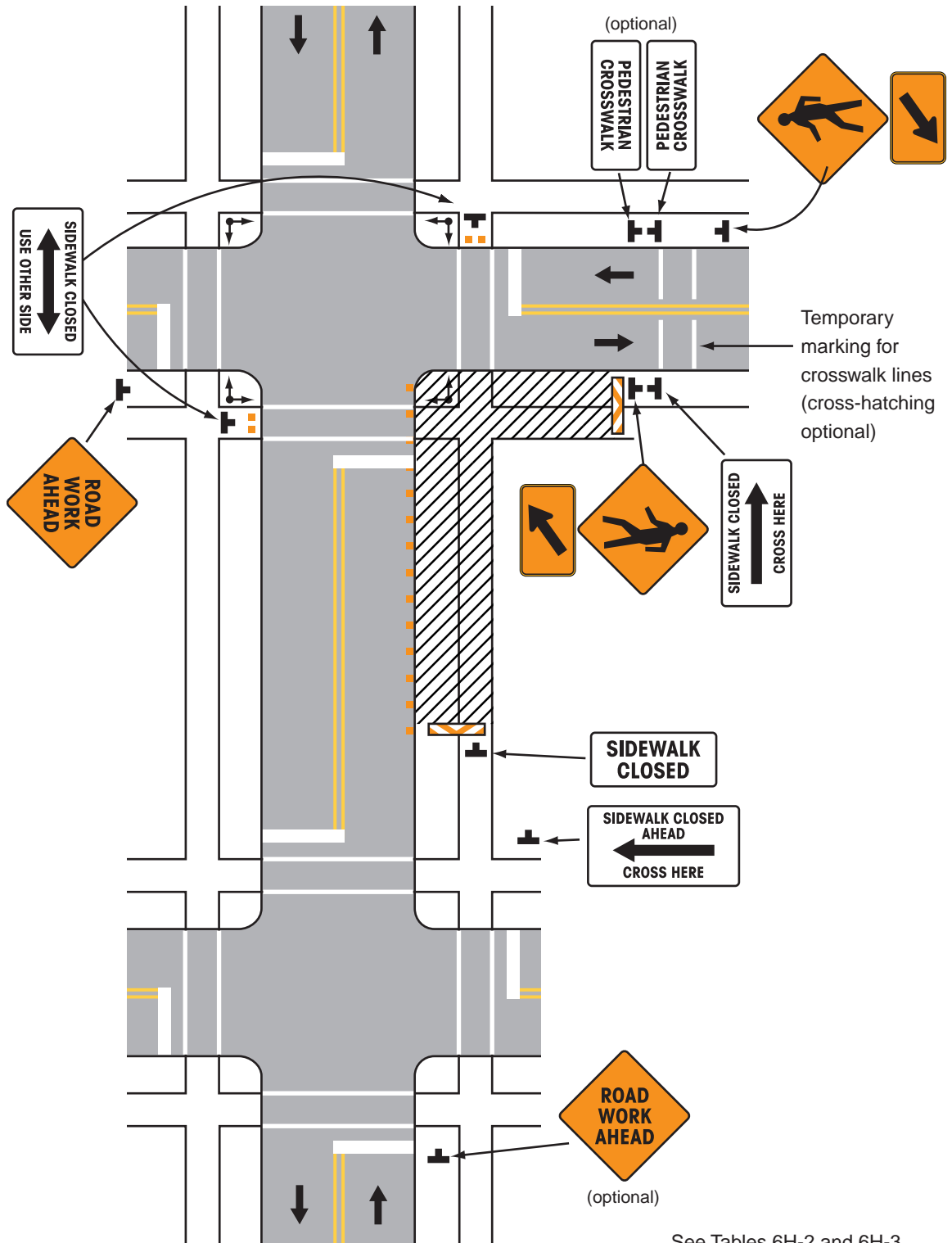

Typical Application 29

See Tables 6H-2 and 6H-3 for the meaning of the symbols and/or letter codes used in this figure.

Notes for Figure 6H-30 – Typical Application 30

Interior Lane Closure on Multi-Lane Street

Guidance:

1. This information applies to low-speed, low-volume urban streets. Where speed or volume is higher, additional signing such as LEFT LANE CLOSED XX M (FT) should be used between the signs shown.

Option:

2. The closure of the adjacent interior lane in the opposing direction may not be necessary, depending upon the activity being performed and the work space needed for the operation.
3. Shadow vehicles with a truck mounted attenuator may be used.

Guidance:

4. When a highway-rail grade crossing exists within or upstream of the transition area and it is anticipated that backups resulting from the lane closure might extend through the highway-rail grade crossing, the temporary traffic control zone should be extended so that the transition area precedes the highway-rail grade crossing.
5. Early coordination with the railroad company should occur before work starts.

Figure 6H-30. Interior Lane Closure on Multi-Lane Street (TA-30)

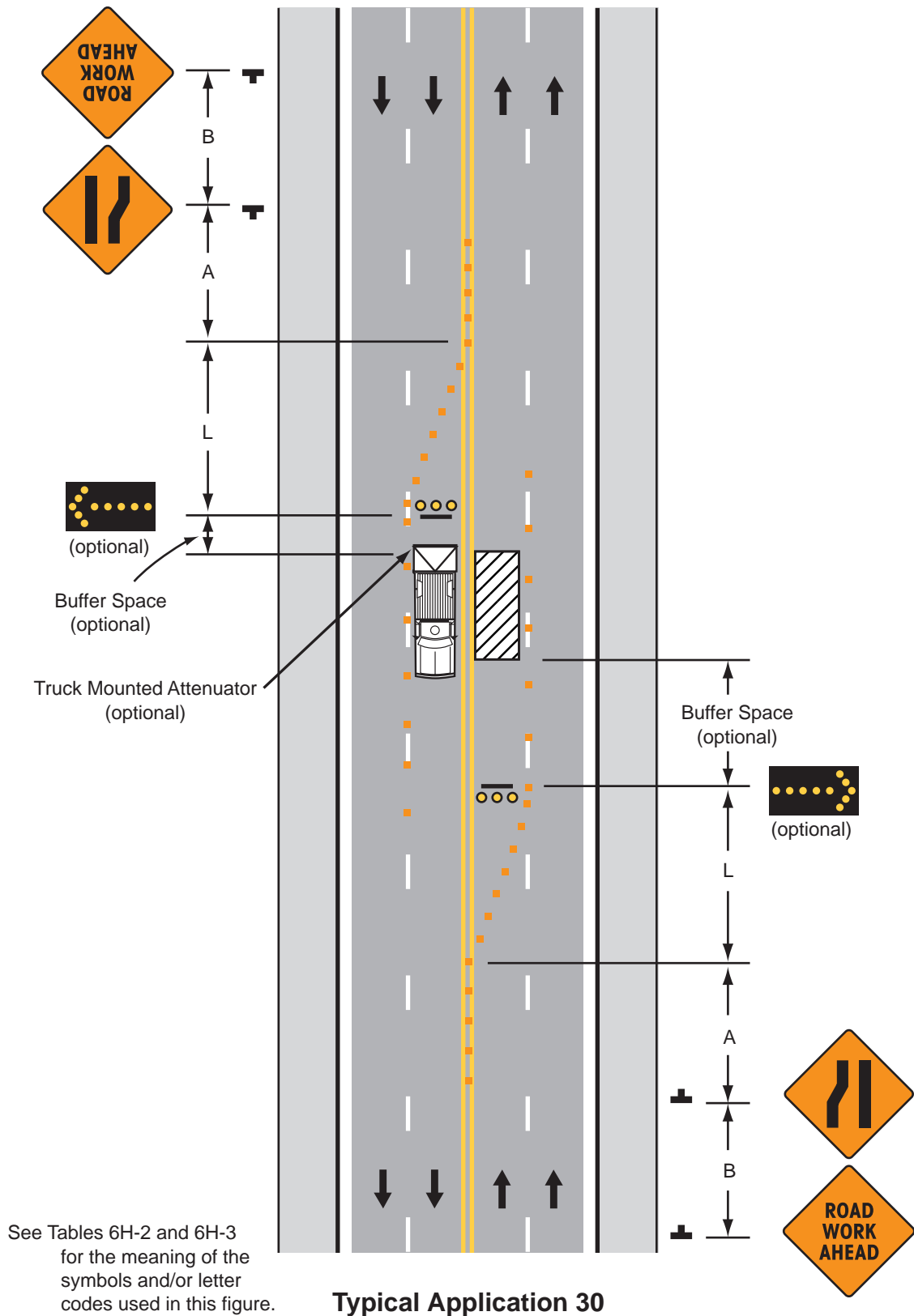

Notes for Figure 6H-31 – Typical Application 31

Lane Closure on Street with Uneven Directional Volumes

Standard:

1. **The illustrated information shall be used only when the motor vehicle traffic volume indicates that two lanes of motor vehicle traffic shall be maintained in the direction of travel for which one lane is closed.**

Option:

2. The procedure may be used during a peak period of motor vehicle traffic and then changed to provide two lanes in the other direction for the other peak.

Guidance:

3. For high speeds, a RIGHT/LEFT LANE CLOSED XX M (FT) sign should be added for motor vehicle traffic approaching the lane closure, as shown in Figure 6H-32.
4. Conflicting pavement markings should be removed for long-term projects. For short-term and intermediate-term projects where this is not practical, the channelizing devices in the area where the pavement markings conflict should be placed at a maximum spacing of $0.1 S$ km ($0.5 S$ feet) where S is the speed. Temporary markings should be installed where needed.
5. If the lane shift has curves with recommended speeds of 50 km/h (30 mph) or less, Reverse Turn signs should be used.
6. Where the shifted section is long, a Reverse Curve sign should be used to show the initial shift and a second sign should be used to show the return to the normal alignment.
7. If the tangent distance along the temporary diversion is less than 180 m (600 ft), the Winding Road sign should be used at the location of the first Reverse Curve sign. The second Reverse Curve sign should be omitted.

Option:

8. A longitudinal buffer space may be used in the activity area to separate opposing motor vehicle traffic.
9. As an alternative, a Double Lane Shift sign may be used displaying one arrow for each lane. An ALL LANES THRU supplemental plaque may be used to emphasize the point that all lanes shift and no lanes are closed.
10. A work vehicle or a shadow vehicle may be equipped with a truck-mounted attenuator.

Figure 6H-31. Lane Closures on Street with Uneven Directional Volumes (TA-31)

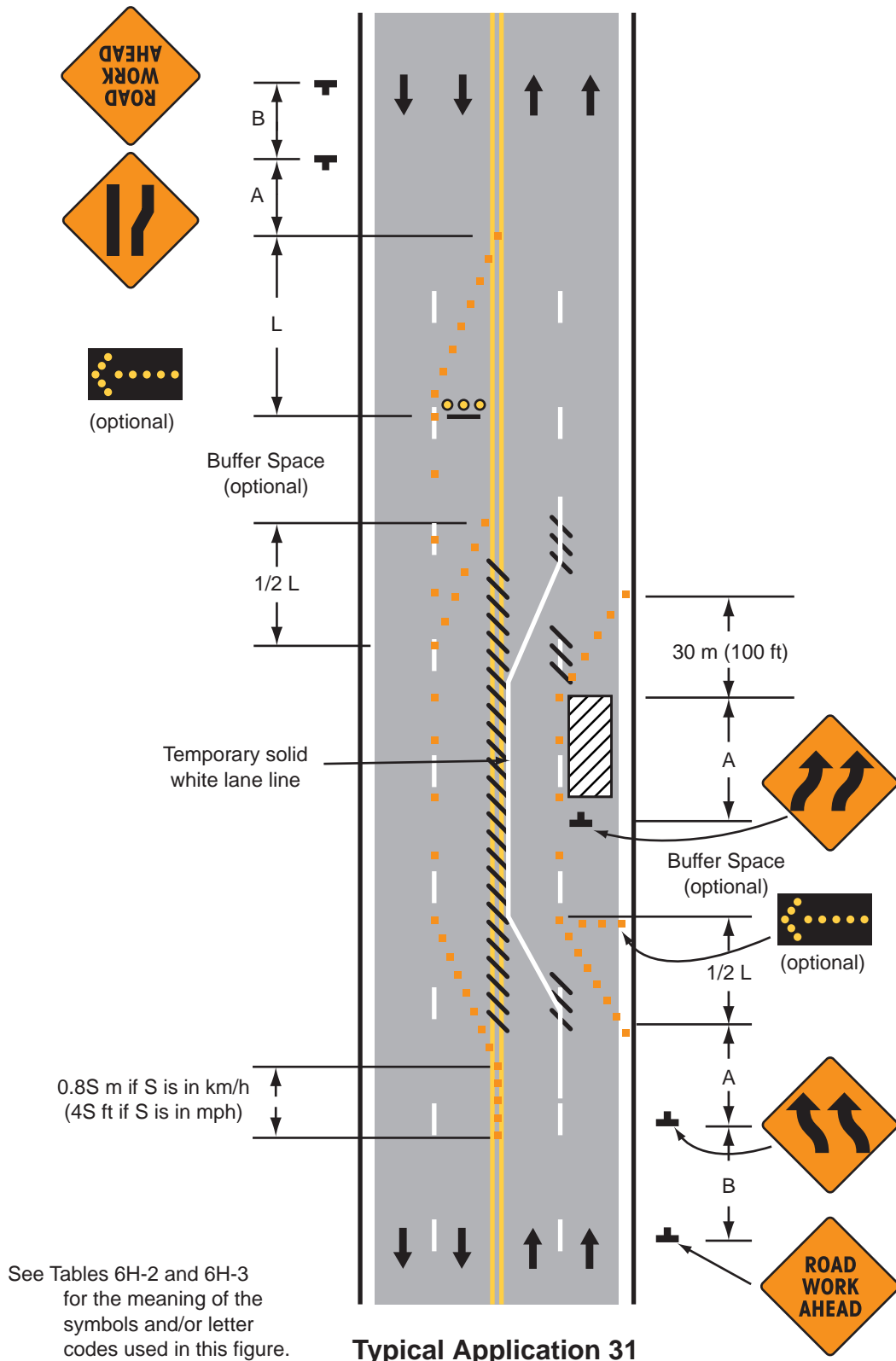

Notes for Figure 6H-32 – Typical Application 32

Half Road Closure on Multi-Lane High-Speed Highway

Standard:

- 1. Pavement markings no longer applicable shall be removed or obliterated as soon as practical. Except for intermediate-term and short-term situations, temporary markings shall be provided to clearly delineate the temporary travel path. For short-term and intermediate-term situations where it is not feasible to remove and restore pavement markings, channelization shall be made dominant by using a very close device spacing.**

Guidance:

2. Where channelizing devices are used instead of pavement markings, the maximum spacing should be $0.1 S$ meters, where S is the speed in km/h ($0.5 S$ feet where S is the speed in mph).

Option:

3. Warning lights may be used to supplement channelizing devices at night.

Guidance:

4. When a highway-rail grade crossing exists within or upstream of the transition area and it is anticipated that backups resulting from the lane closure might extend through the highway-rail grade crossing, the temporary traffic control zone should be extended so that the transition area precedes the highway-rail grade crossing.
5. When a highway-rail grade crossing exists within the activity area, provisions should be made to provide drivers operating on the left side of the normal centerline with comparable warning devices as supplied for drivers operating on the right side of the normal centerline.
6. Early coordination with the railroad company should occur before work starts.

Option:

7. A flagger may be used at the highway-rail grade crossing to minimize the probability that vehicles are stopped within 4.5 m (15 ft) of the highway-rail grade crossing, measured from both sides of the outside rails.
8. A truck-mounted attenuator may be used on the work vehicle and/or the shadow vehicle.

Figure 6H-32. Half Road Closure on Multi-Lane, High-Speed Highway (TA-32)

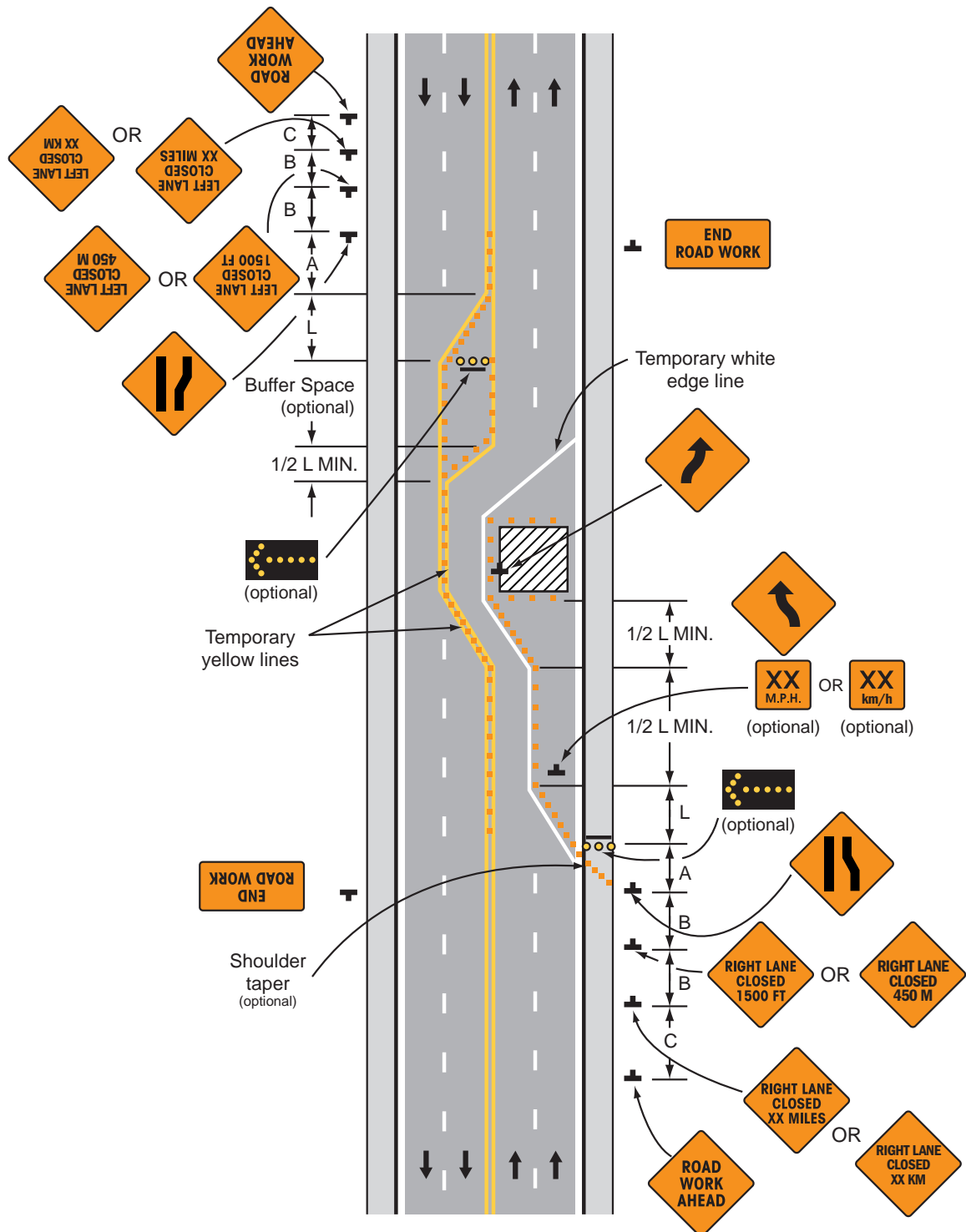

Note: See Tables 6H-2 and 6H-3 for the meaning of the symbols and/or letter codes used in this figure.

Typical Application 32

Notes for Figure 6H-33 – Typical Application 33

Stationary Lane Closure on Divided Highway

Standard:

- 1. This information also shall be used when work is being performed in the lane adjacent to the median on a divided highway. In this case, the LEFT LANE CLOSED signs and the corresponding LANE REDUCTION signs shall be substituted.**
- 2. When a side road intersects the highway within the temporary traffic control zone, additional temporary traffic control devices shall be placed as needed.**

Guidance:

3. All vehicles, equipment, workers and their activities should be restricted to one side of the pavement.

Option:

4. A truck-mounted attenuator may be used on the work vehicle and/or shadow vehicle.

Figure 6H-33. Stationary Lane Closure on Divided Highway (TA-33)

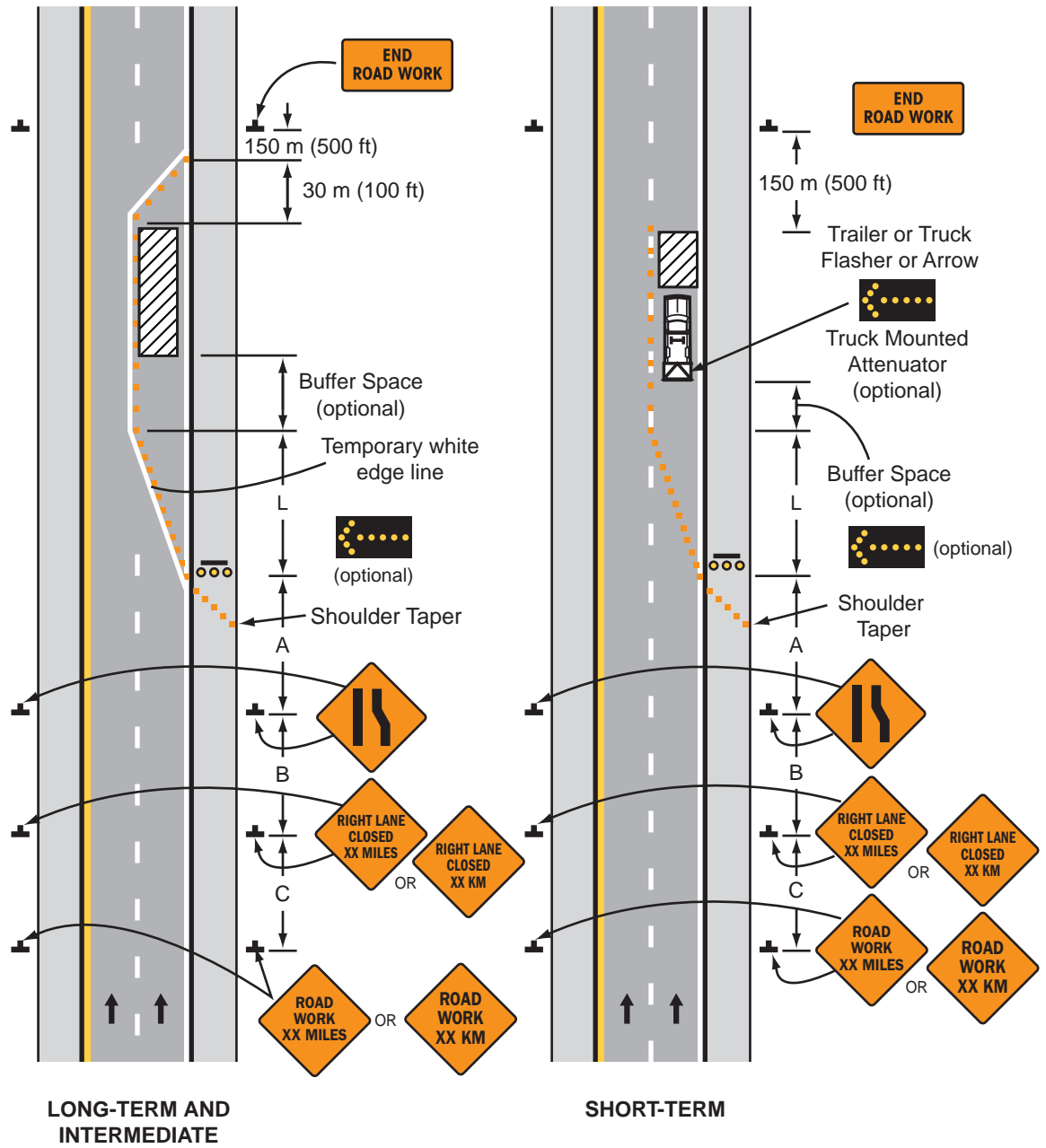

Typical Application 33

Note: See Tables 6H-2 and 6H-3 for the meaning of the symbols and/or letter codes used in this figure.

Notes for Figure 6H-34 – Typical Application 34

Lane Closure with Temporary Traffic Barrier

Guidance:

1. For long-term lane closures on facilities with permanent edge lines, a temporary edge line should be installed from the start of the taper to the downstream point where the barrier crosses the permanent edge line, and conflicting pavement markings should be removed.
2. The use of a barrier should be based on engineering judgment. For end treatments of temporary traffic barriers, see Section 6F.75.

Standard:

- 3. The barrier shall not be placed along the merging taper. The lane shall first be closed using channelizing devices and pavement markings.**

Option:

4. The barrier shown in this typical application is an example of one method that may be used to close a lane for a long-term project. If the work activity permits, a movable barrier may be used and relocated to the shoulder during non-work periods or peak-period motor vehicle traffic conditions, as appropriate.
5. Type C Steady-Burn warning lights may be placed on channelizing devices and the barrier parallel to the edge of pavement for nighttime lane closures.

Standard:

- 6. If a movable barrier is used, the temporary white edge line shown in the typical application shall not be used. During the period when the right lane is opened, the sign legends and the channelization shall be changed to indicate that only the shoulder is closed, as illustrated in Figure 6H-5. The arrow panel, if used, shall be placed at the end of the shoulder taper and shall display the caution mode.**

Guidance:

7. If a movable barrier is used, the shift should be performed in the following manner. When closing the lane, the lane should be initially closed with channelizing devices placed along a merging taper using the same information employed for a stationary lane closure. The lane closure should then be extended with the movable-barrier transfer vehicle moving with motor vehicle traffic. When opening the lane, the movable-barrier transfer vehicle should travel against motor vehicle traffic from the termination area to the transition area. The merging taper should then be removed using the same information employed for a stationary lane closure.

Figure 6H-34. Lane Closure with Temporary Traffic Barrier (TA-34)

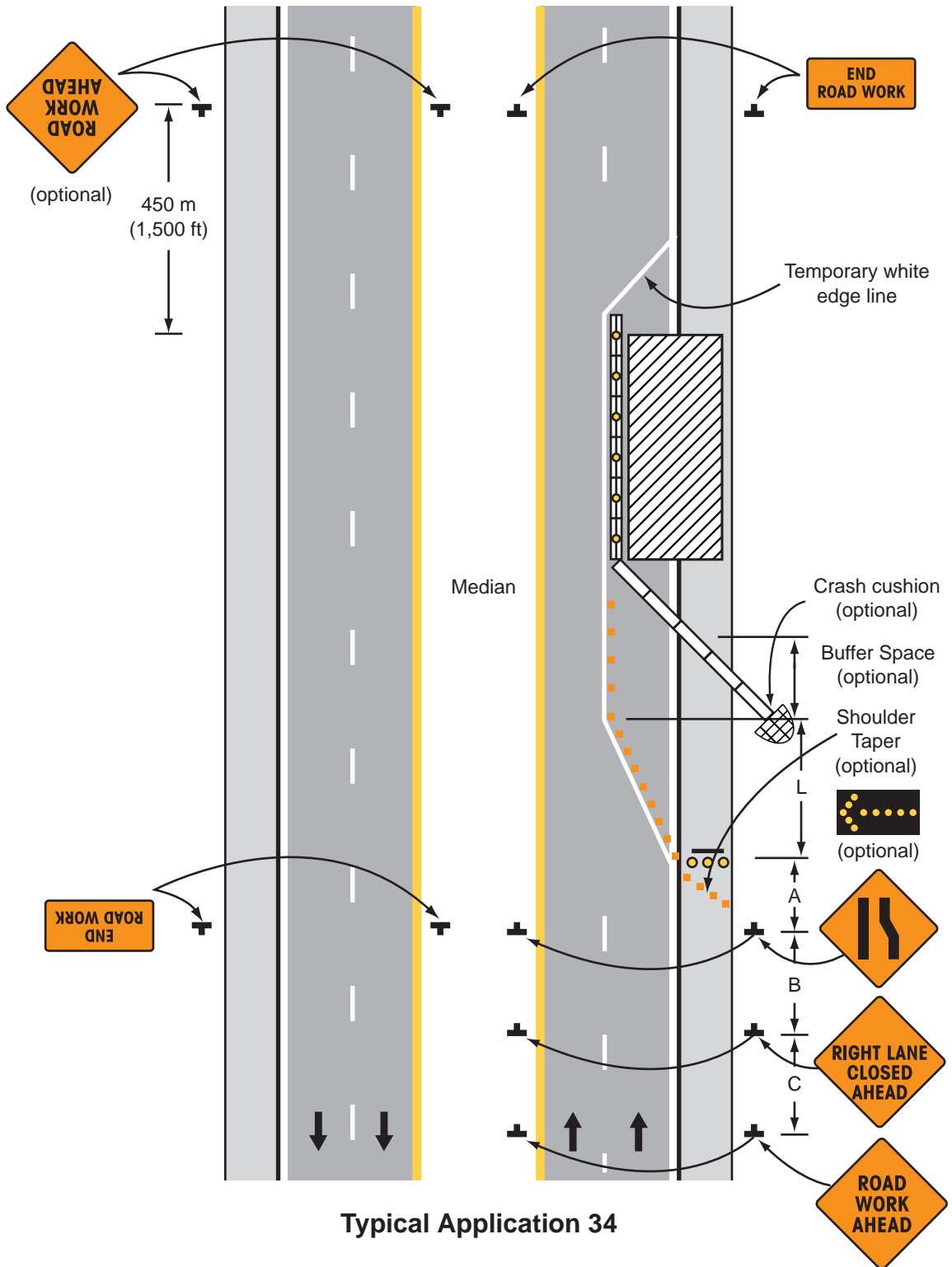

Note: See Tables 6H-2 and 6H-3 for the meaning of the symbols and/or letter codes used in this figure.

Notes for Figure 6H-35 – Typical Application 35

Mobile Operation on Multi-Lane Road

Standard:

1. **Arrow panels shall, as a minimum, be Type B, with a size of 1,500 x 750 mm (60 x 30 in).**

Guidance:

2. Vehicles used for these operations should be made highly visible with appropriate equipment, such as: rotating lights, strobe lights, flags, signs or arrow panels.
3. Shadow Vehicle 1 should be equipped with an arrow panel and truck-mounted attenuator.
4. Shadow Vehicle 2 should be equipped with an arrow panel. An appropriate lane closure sign should be placed on Shadow Vehicle 2 so as not to obscure the arrow panel.
5. Shadow Vehicle 2 should travel at a varying distance from the work operation so as to provide adequate sight distance for motor vehicle traffic approaching from the rear.
6. The spacing between the work vehicles and the shadow vehicles, and between each shadow vehicle should be minimized to deter road users from driving in between.
7. Work should normally be accomplished during off-peak hours.
8. When the work vehicle occupies an interior lane (a lane other than the far right or far left) of a directional roadway having a right shoulder 3 m (10 ft) or more in width, Shadow Vehicle 2 should drive the right shoulder with a sign indicating that work is taking place in the interior lane.

Option:

9. A truck-mounted attenuator may be used on Shadow Vehicle 2.
10. On high-speed roadways, a third shadow vehicle (not shown) may be used with Shadow Vehicle 1 in the closed lane, Shadow Vehicle 2 straddling the edge line, and Shadow Vehicle 3 on the shoulder.
11. Where adequate shoulder width is not available, Shadow Vehicle 3 may drive partially in the lane.

Figure 6H-35. Mobile Operation on Multi-Lane Road (TA-35)

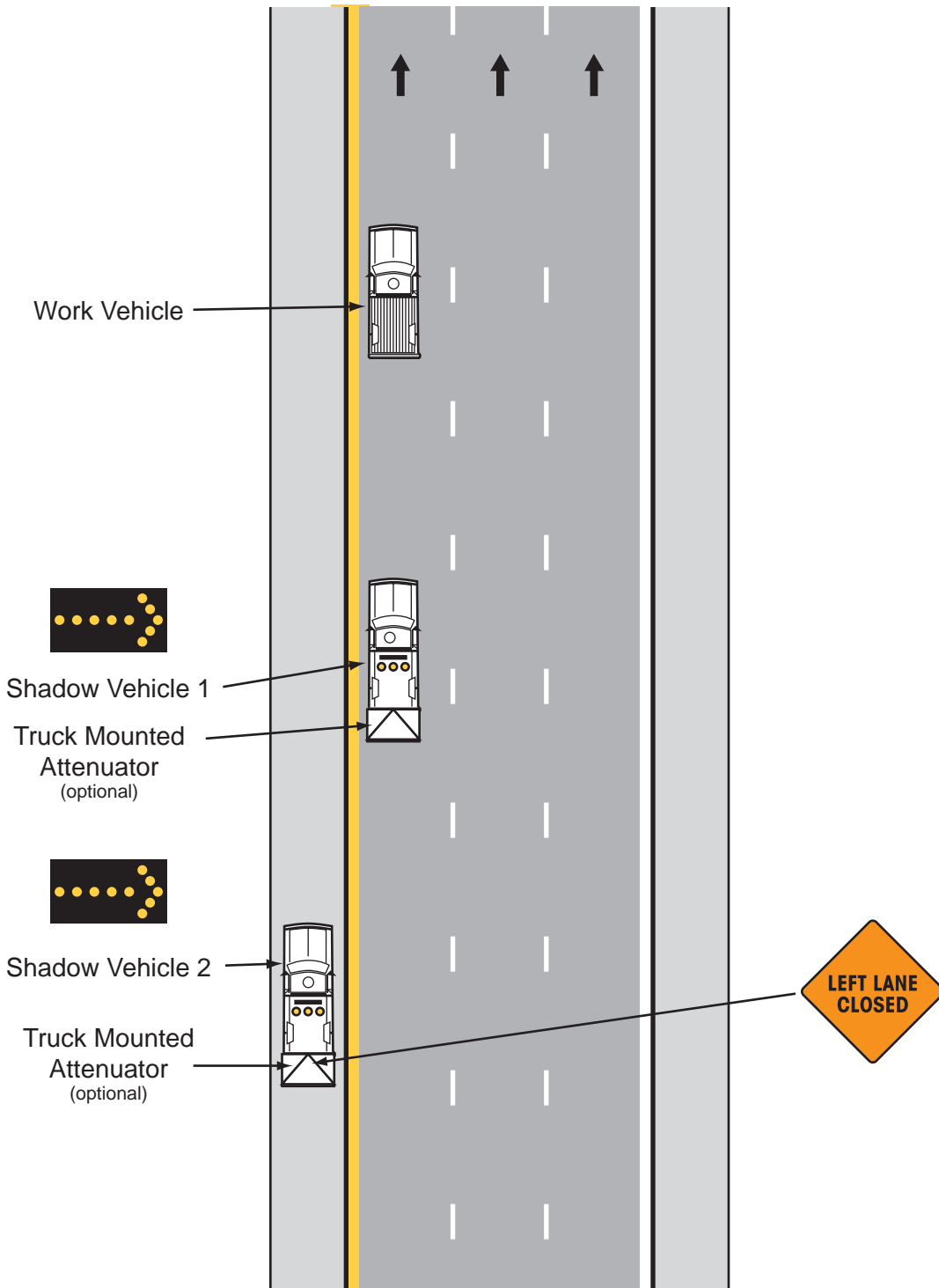

Note: See Tables 6H-2 and 6H-3 for the meaning of the symbols and/or letter codes used in this figure.

Typical Application 35

Notes for Figure 6H-36 – Typical Application 36

Lane Shift on Freeway

Guidance:

1. The lane shift should be used when the work space extends into either the right or left lane of a divided highway and it is not practical, for capacity reasons, to reduce the number of available lanes.
2. When a lane shift is accomplished by using: (1) geometry that meets the design speed at which the permanent highway was designed, (2) full normal cross-section (full lane width and full shoulders), and (3) complete pavement markings, then only the initial general work-zone warning sign is required.
3. When the conditions in Note 2 are not met, the information shown in the typical application should be employed and all the following notes apply.

Standard:

- 4. A warning sign shall be used to show the changed alignment.**

Guidance:

5. Where the shifted section is longer than 180 m (600 ft), one set of Reverse Curve signs should be used to show the initial shift and a second set should be used to show the return to the normal alignment. If the tangent distance along the temporary diversion is less than 180 m (600 ft), the Winding Road sign should be used instead of the first Reverse Curve sign. The second Reverse Curve sign should be omitted.
6. If a STAY IN LANE sign is used, then solid white lane lines should be used.

Standard:

- 7. The minimum width of the shoulder lane shall be 3 m (10 ft).**
- 8. For long-term stationary work, existing conflicting pavement markings shall be removed and temporary markings shall be installed before traffic patterns are changed.**

Option:

9. For short-term stationary work, lanes may be delineated by channelizing devices or removable pavement markings instead of temporary pavement markings.
10. Triple Lane Shift signs may be used in place of the Reverse Curve signs. ALL LANES THRU supplemental plaques may be used to emphasize the point that all lanes shift and no lanes are closed.
11. If the shoulder cannot adequately accommodate trucks, trucks may be directed to use the travel lanes.
12. The barrier shown in this typical application is one method that may be used to close a lane for a long-term project (see Section 6F.75 for end treatments).

Guidance:

13. The use of a barrier should be based on engineering judgment.

Option:

14. Type C Steady-Burn warning lights may be placed on channelizing devices and the barrier parallel to the edge of pavement for nighttime lane closures.

Figure 6H-36. Lane Shift on Freeway (TA-36)

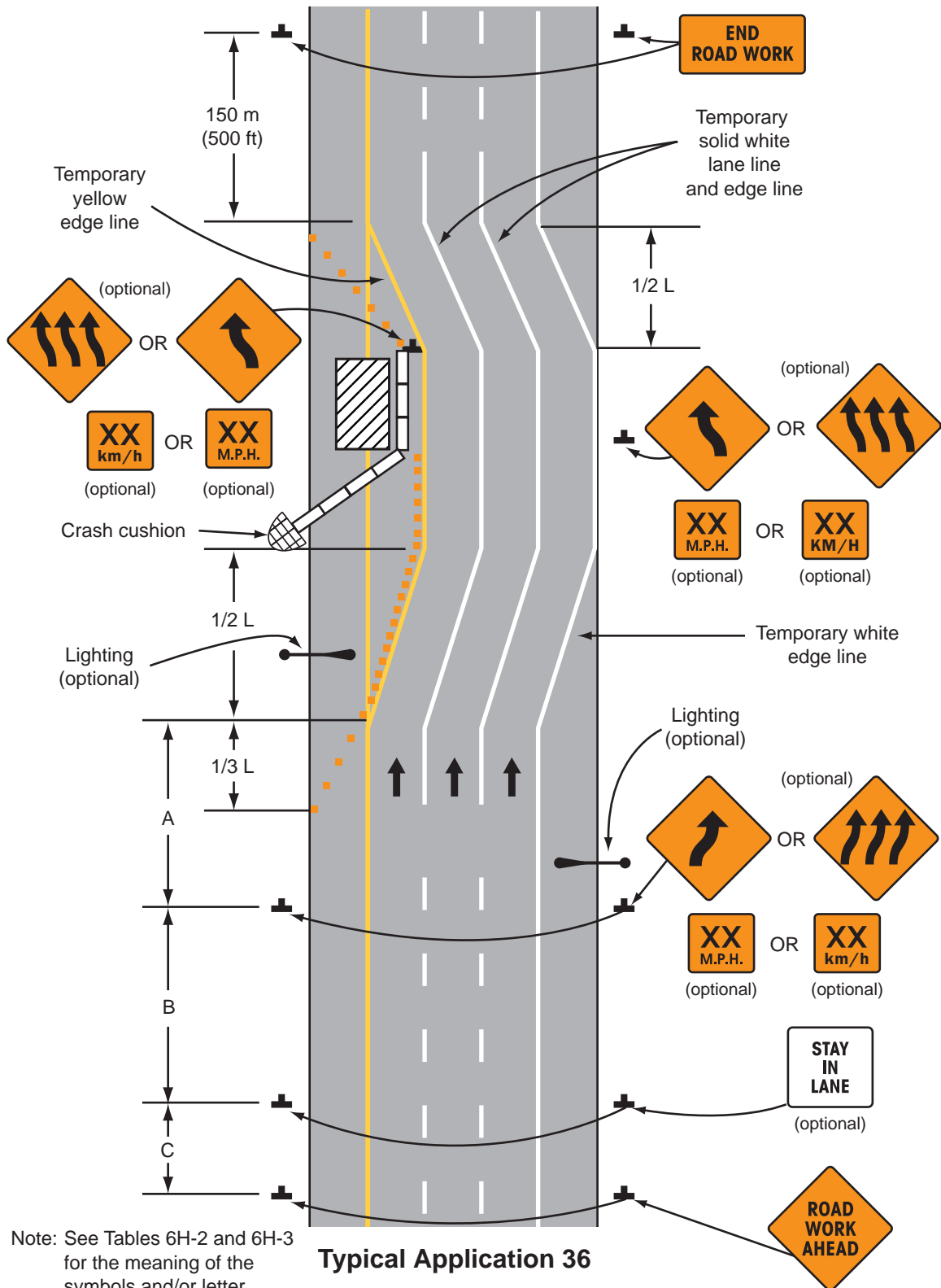

Note: See Tables 6H-2 and 6H-3 for the meaning of the symbols and/or letter codes used in this figure.

Typical Application 36

Notes for Figure 6H-37 – Typical Application 37

Double Lane Closure on Freeway

Guidance:

1. Ordinarily, the preferred position for the second arrow panel is in the closed exterior lane at the beginning of the second merging taper. However, the second arrow panel should be placed in the closed interior lane at the end of the second merging taper in the following situations:
 - a. When a shadow vehicle is used in the interior closed lane, and the second arrow panel is mounted on the shadow vehicle.
 - b. If alignment or other conditions create any confusion as to which lane is closed by the second arrow panel.
 - c. When the first arrow panel is placed in the closed exterior lane at the end of the first merging taper (the alternative position when the shoulder is narrow).

Option:

2. Flashing warning lights and/or flags may be used to call attention to the initial warning signs.
3. A truck-mounted attenuator may be used on the shadow vehicle.
4. If a paved shoulder having a minimum width of 3 m (10 ft) and sufficient strength is available, the left and center lanes may be closed and motor vehicle traffic carried around the work space on the right lane and a right shoulder.
5. If the shoulder cannot adequately accommodate trucks, trucks may be directed to use the travel lanes.

Figure 6H-37. Double Lane Closure on Freeway (TA-37)

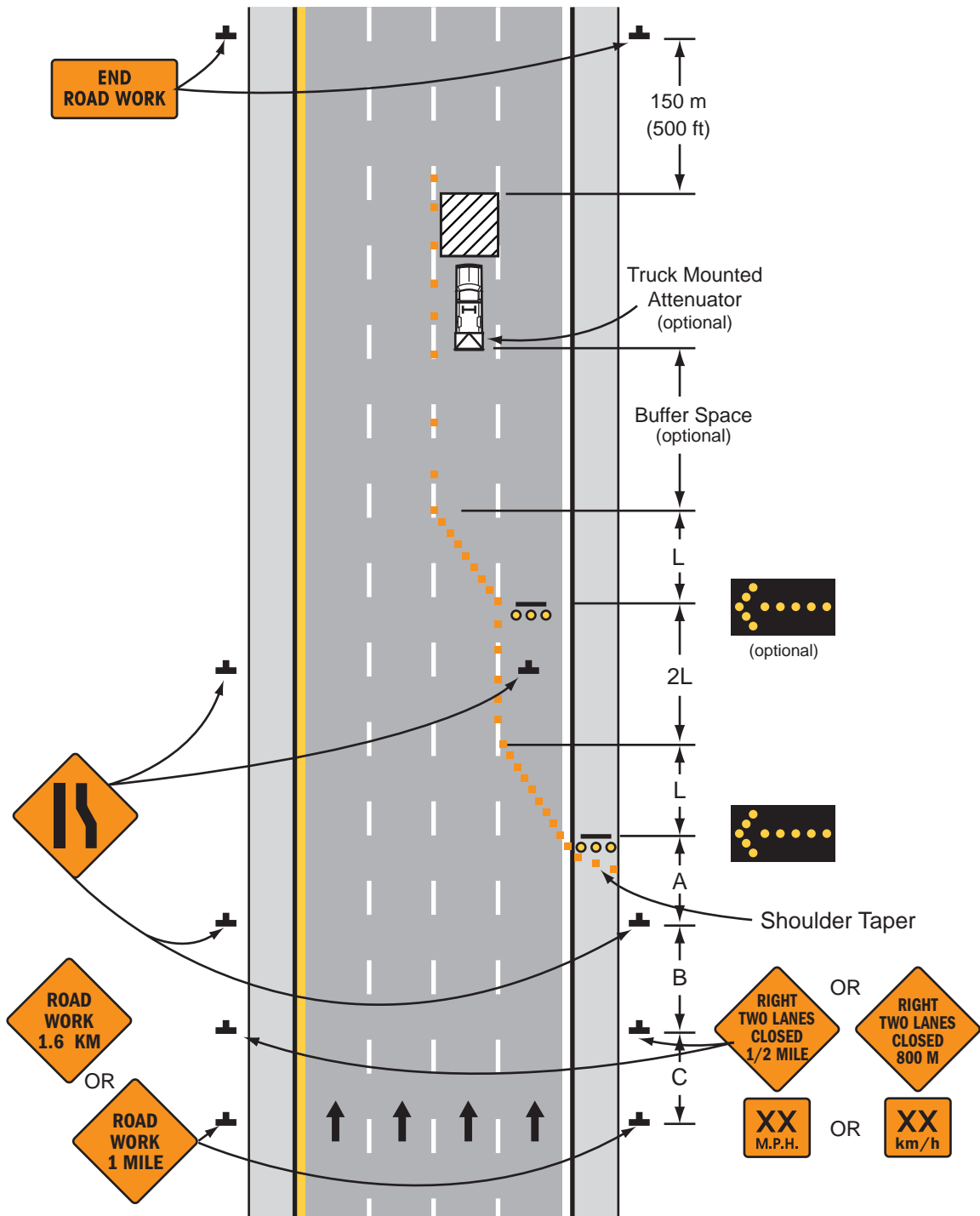

Typical Application 37

Note: See Tables 6H-2 and 6H-3 for the meaning of the symbols and/or letter codes used in this figure.

Notes for Figure 6H-38 – Typical Application 38

Interior Lane Closure on Freeway

Guidance:

1. For a long-term closure, a barrier should be used to provide additional safety to the operation in the closed interior lane. A buffer space should be used at the upstream end of the closed interior lane.
2. The first arrow panel displaying a right arrow should be on the left shoulder at the beginning of the taper. The arrow panel displaying a double arrow should be centered in the closed interior lane and placed at the downstream end of the shifting taper.
3. The placement of signs should not obstruct or obscure arrow panels.
4. For long-term use, the dashed lane lines should be made solid white in the two-lane section.

Option:

5. As the arrow panel with a double arrow displayed is key, the arrow panel closing the exterior lane may be moved or omitted if the alignment is such that the two panels create confusion.
6. As an alternative to initially closing the left lane, as shown in the typical application, the right lane may be closed in advance of the interior lane closure with appropriate channelization and signs.
7. A short, single row of channelizing devices in advance of the motor vehicle traffic split to restrict motor vehicle traffic to their respective lanes may be added.
8. DO NOT PASS signs may be used.
9. If a paved shoulder having a minimum width of 3 m (10 ft) and sufficient strength is available, the left and center lanes may be closed and motor vehicle traffic carried around the work space on the right lane and a right shoulder.
10. If the shoulder cannot adequately accommodate trucks, trucks may be directed to use the travel lanes.

Figure 6H-38. Interior Lane Closure on Freeway (TA-38)

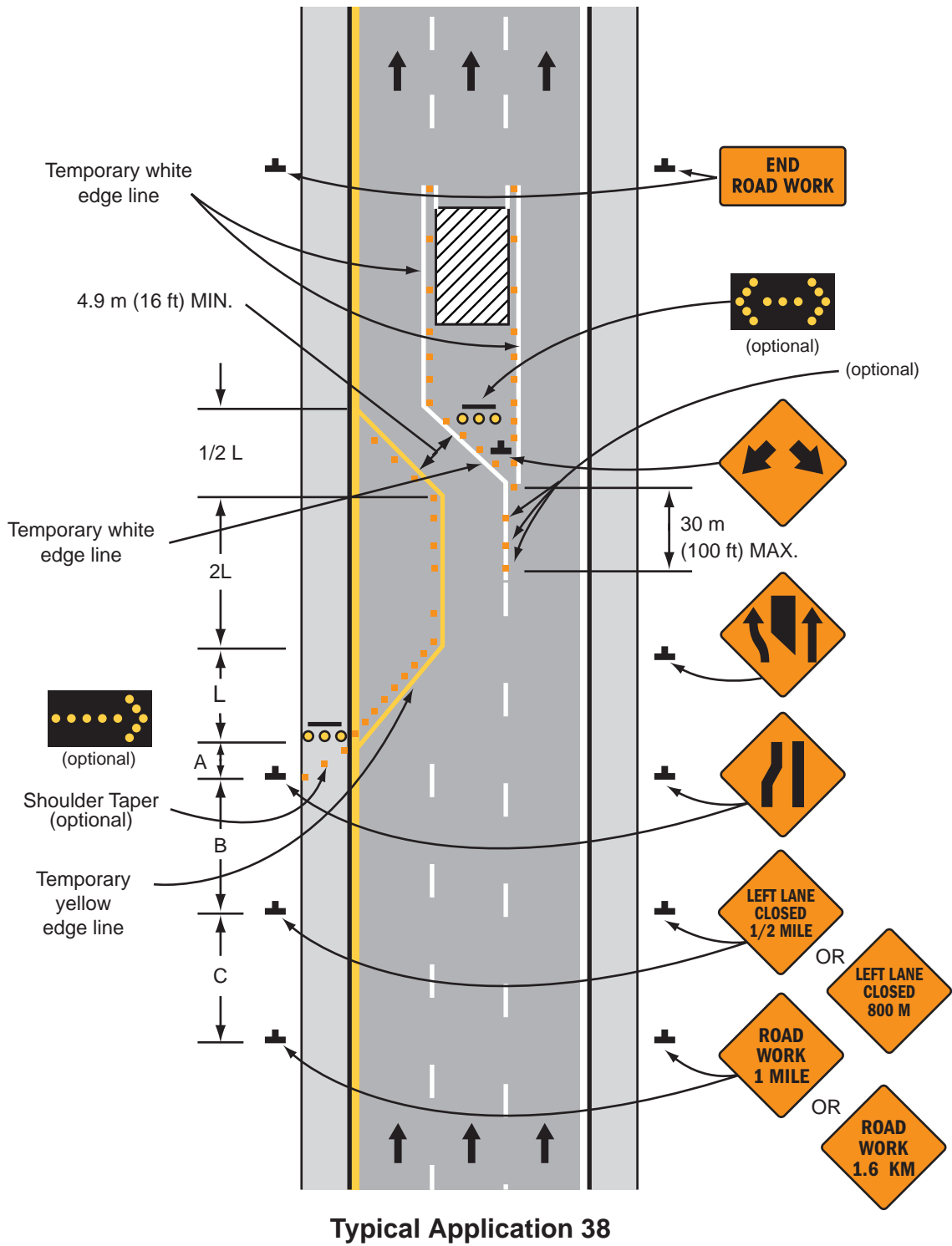

Note: See Tables 6H-2 and 6H-3 for the meaning of the symbols and/or letter codes used in this figure.

Notes for Figure 6H-39 – Typical Application 39

Median Crossover on Freeway

Standard:

- 1. Channelizing devices or temporary traffic barriers shall be used to separate opposing motor vehicle traffic.**

Guidance:

2. For long-term work on high-speed, high-volume highways, consideration should be given to using a temporary traffic barrier to separate opposing motor vehicle traffic.

Option:

3. When a temporary traffic barrier is used to separate opposing motor vehicle traffic, the Two-Way Traffic, DO NOT PASS, KEEP RIGHT, and DO NOT ENTER signs may be eliminated.
4. The alignment of the crossover may be designed as a reverse curve.

Guidance:

5. When the crossover follows a curved alignment, the design criteria contained in the AASHTO "Policy on the Geometric Design of Highways and Streets" should be used (see Section 1A.11).
6. When channelizing devices have the potential of leading motor vehicle traffic out of the intended traffic space, the channelizing devices should be extended a distance in meters (feet) of 0.4 the speed limit in km/h (2 times the speed limit in mph) beyond the end of the transition area as depicted.
7. Where channelizing devices are used, the Two-Way Traffic signs should be repeated every 1.6 km (1 mi).

Option:

8. NEXT X KM (MILES) Supplemental Distance plaques may be used with the Two Way Traffic signs, where X is the distance to the end of the two-way section.

Support:

9. When the distance is sufficiently short that drivers entering the section can see the far end of the section, they are less likely to forget that there is opposing motor vehicle traffic.
10. The sign legends for the four pairs of signs approaching the lane closure for the non-crossover direction of travel are not shown. They are similar to the series shown for the crossover direction, except that the left lane is closed.

Figure 6H-39. Median Crossover on Freeway (TA-39)

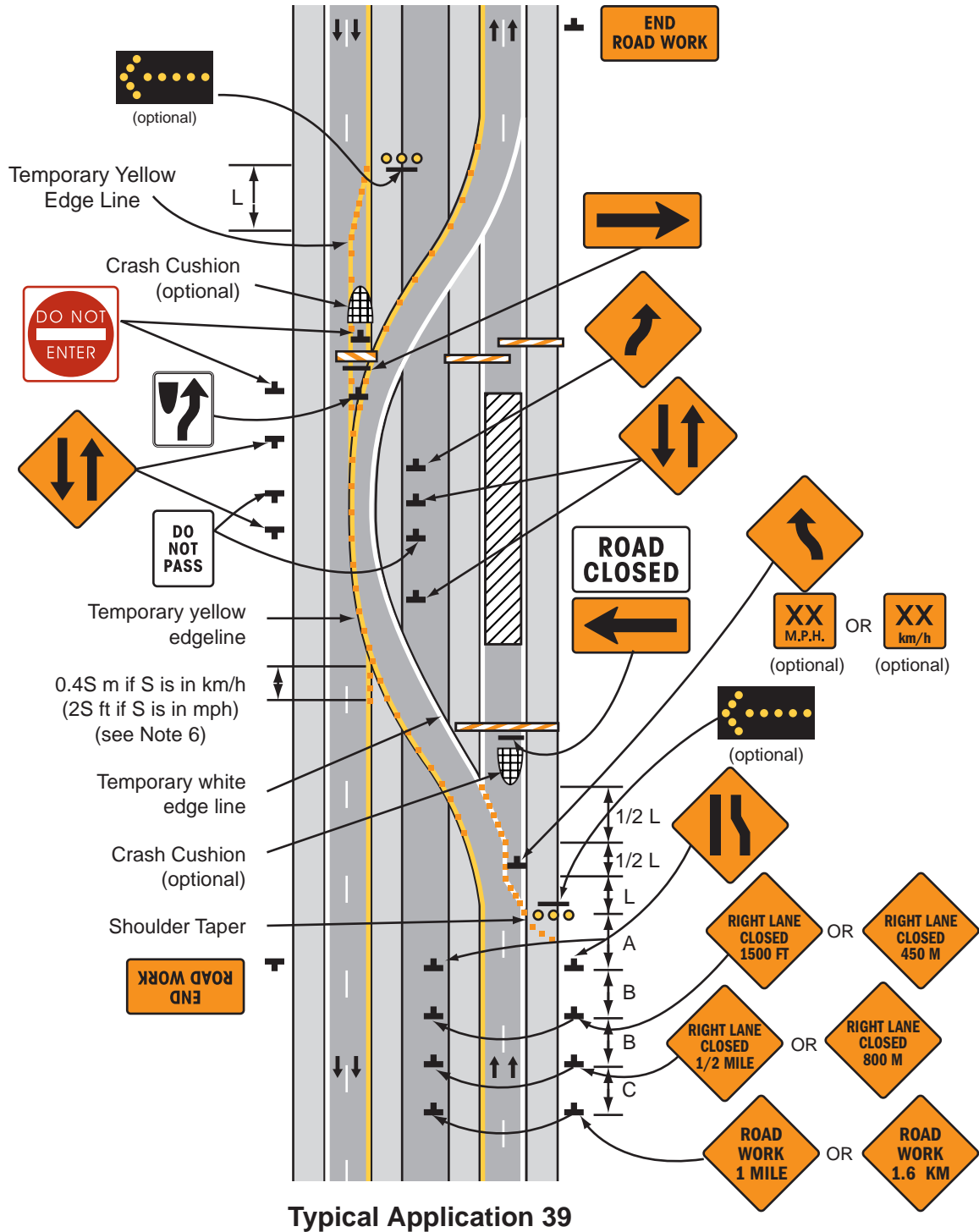

Note: See Tables 6H-2 and 6H-3 for the meaning of the symbols and/or letter codes used in this figure.

Notes for Figure 6H-40 – Typical Application 40

Median Crossover for Entrance Ramp

Guidance:

1. The typical application illustrated should be used for carrying an entrance ramp across a closed directional roadway of a divided highway.
2. A temporary acceleration lane should be used to facilitate merging.
3. When used, the YIELD or STOP sign should be located far enough forward to provide adequate sight distance of oncoming mainline motor vehicle traffic to select a safe gap. Also, a longer acceleration lane should be provided beyond the sign to reduce the gap size needed.

Option:

4. If motor vehicle traffic conditions allow, the ramp may be closed.
5. A broken edge line may be carried across the temporary entrance ramp to assist in defining the through motor vehicle traffic lane.
6. When a temporary traffic barrier is used to separate opposing motor vehicle traffic, the Two-Way Traffic signs and the DO NOT ENTER signs may be eliminated.

Figure 6H-40. Median Crossover for Entrance Ramp (TA-40)

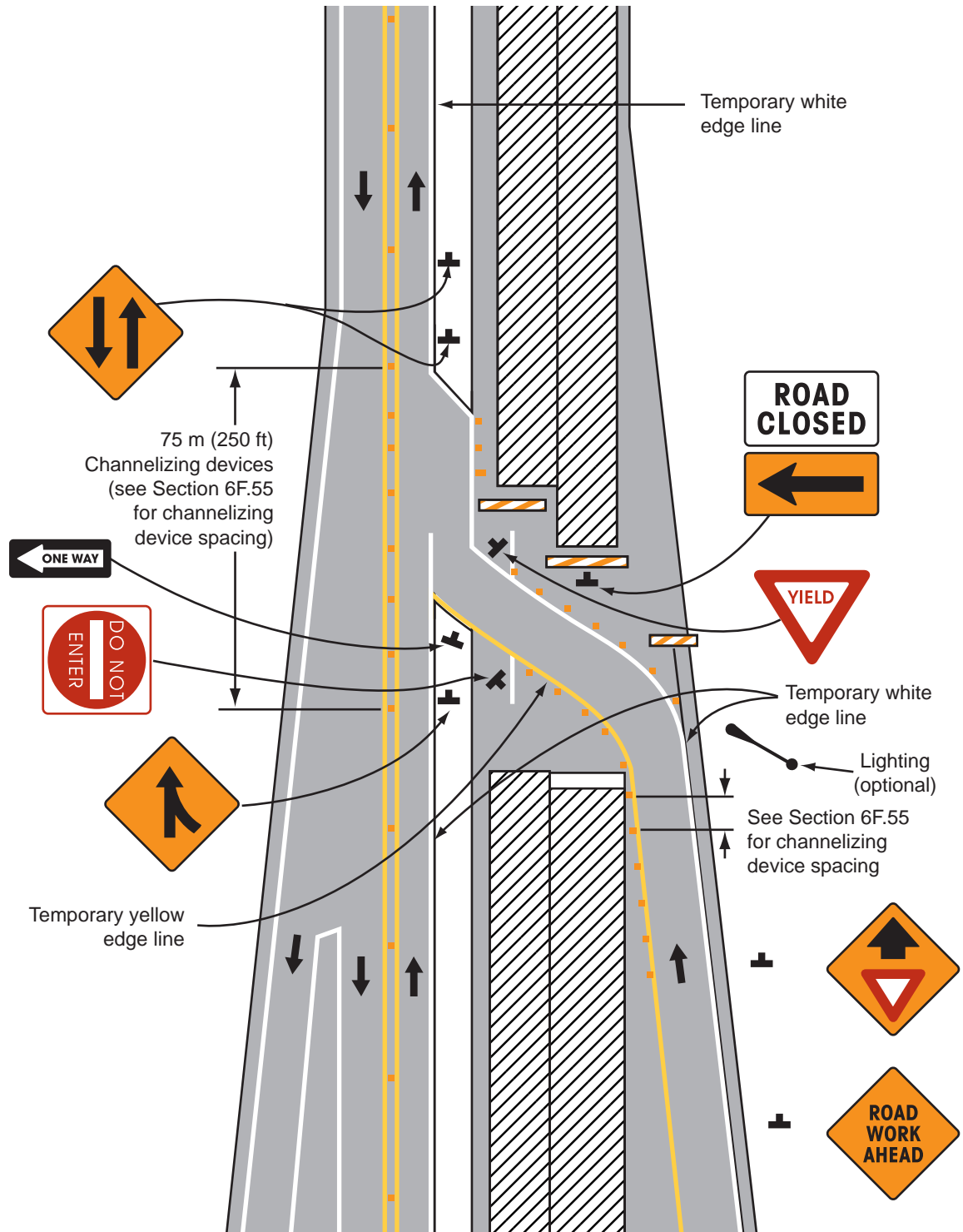

Note: See Tables 6H-2 and 6H-3 for the meaning of the symbols and/or letter codes used in this figure.

Typical Application 40

Notes for Figure 6H-41 – Typical Application 41

Median Crossover for Exit Ramp

Guidance:

1. This typical application should be used for carrying an exit ramp across a closed directional roadway of a divided highway. The design criteria contained in the AASHTO "Policy on the Geometric Design of Highways and Streets" (see Section 1A.11) should be used for determining the curved alignment.
2. The guide signs should indicate that the ramp is open, and where the temporary ramp is located. Conversely if the ramp is closed, guide signs should indicate that the ramp is closed.
3. A black on orange EXIT CLOSED panel should be placed diagonally across the interchange/ intersection guide signs.
4. In the situation (not shown) where channelizing devices are placed along the mainline roadway, the devices spacing should be reduced in the vicinity of the off ramp to emphasize the opening at the ramp itself. Channelizing devices and/or temporary pavement markings should be placed on both sides of the temporary ramp where it crosses the median and the closed roadway.
5. Advance guide signs providing information related to the temporary exit should be relocated or duplicated adjacent to the temporary roadway.

Standard:

- 6. A temporary EXIT sign shall be located in the temporary gore. For better visibility, it shall be mounted a minimum of 2.1 m (7 ft) from the pavement surface to the bottom of the sign.**

Option:

7. Guide signs referring to the exit may need to be relocated to the median.
8. The temporary EXIT sign placed in the temporary gore may be either black on orange or white on green.
9. In some instances, a temporary deceleration lane may be useful in facilitating the exiting maneuver.
10. When a temporary traffic barrier is used to separate opposing motor vehicle traffic, the Two-Way Traffic signs may be omitted.

Figure 6H-41. Median Crossover for Exit Ramp (TA-41)

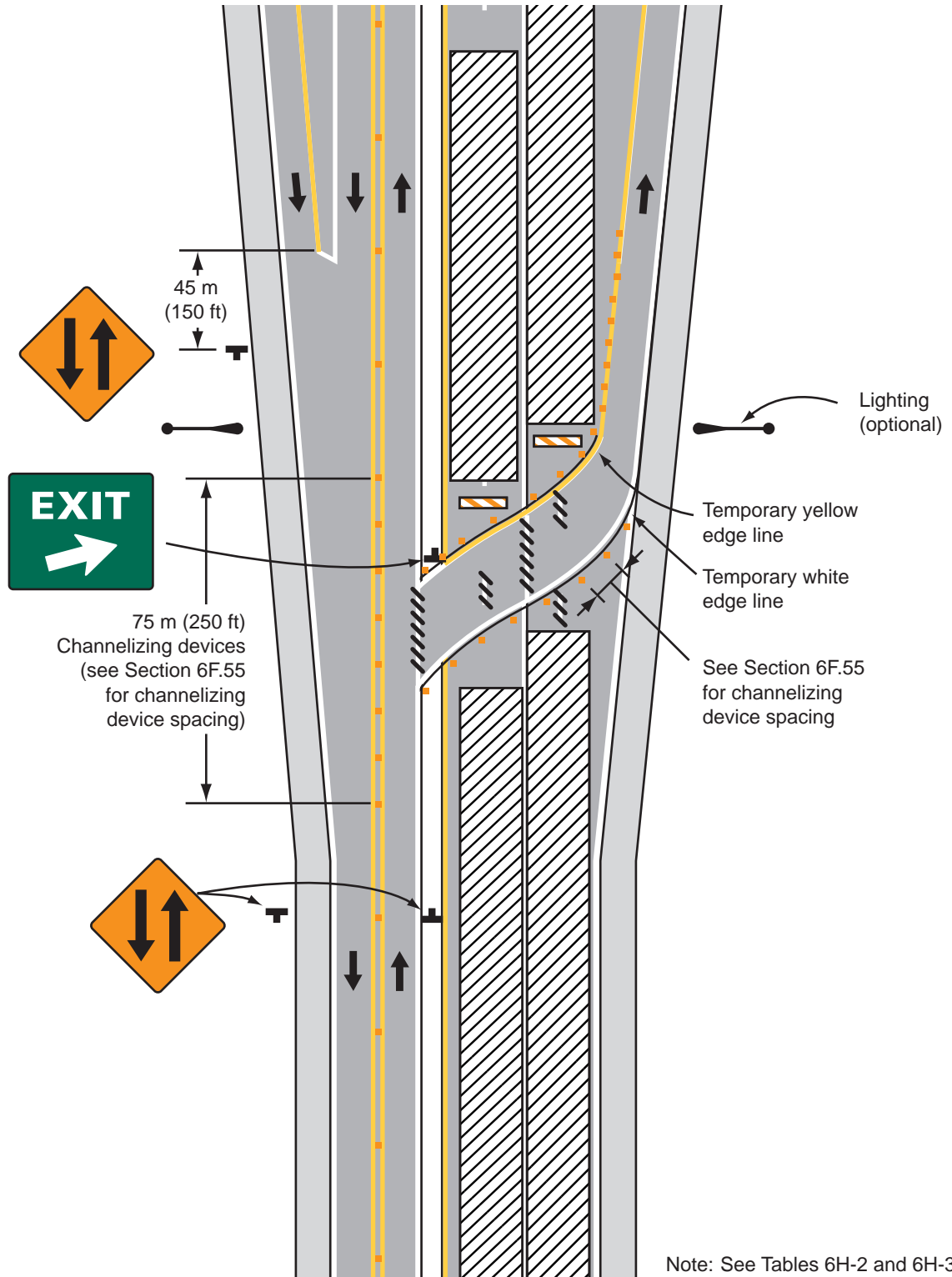

Typical Application 41

Note: See Tables 6H-2 and 6H-3 for the meaning of the symbols and/or letter codes used in this figure.

Notes for Figure 6H-42 – Typical Application 42

Work in Vicinity of Exit Ramp

Guidance:

1. The guide signs should indicate that the ramp is open, and where the temporary ramp is located. However, if the ramp is closed, guide signs should indicate that the ramp is closed.
2. A black on orange EXIT CLOSED panel should be placed diagonally across from the interchange/ intersection guide signs.
3. The design criteria contained in the AASHTO "Policy on the Geometric Design of Highways and Streets" should be used for determining the curved alignment (see Section 1A.11).

Standard:

- 4. A temporary EXIT sign shall be located in the temporary gore. For better visibility, it shall be mounted a minimum of 2.1 m (7 ft) from the pavement surface to the bottom of the sign.**

Option:

5. An alternative procedure is to channelize exiting motor vehicle traffic onto the right shoulder, and close the lane as necessary.
6. If a paved shoulder having a minimum width of 3 m (10 ft) and sufficient strength is available, the left and center lanes may be closed and motor vehicle traffic carried around the work space on the right lane and a right shoulder.
7. If the shoulder cannot adequately accommodate trucks, trucks may be directed to use the travel lanes.
8. A buffer may be used.

Figure 6H-42. Work in Vicinity of Exit Ramp (TA-42)

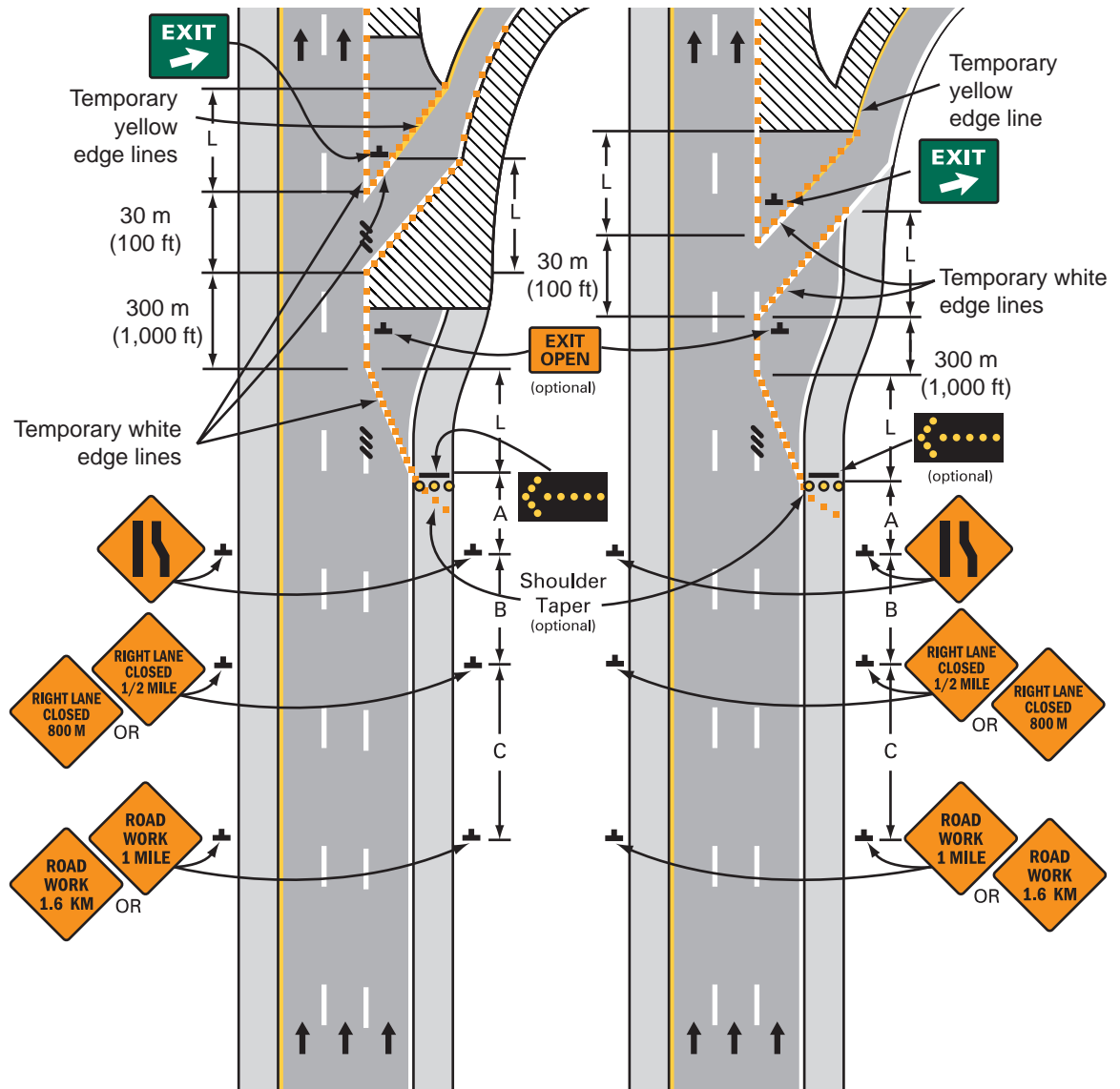

Typical Application 42

Note: See Tables 6H-2 and 6H-3 for the meaning of the symbols and/or letter codes used in this figure.

Notes for Figure 6H-43 – Typical Application 43

Partial Exit Ramp Closure

Guidance:

1. Truck off-tracking should be considered when determining whether the minimum lane width of 3 m (10 ft) is adequate.

Figure 6H-43. Partial Exit Ramp Closure (TA-43)

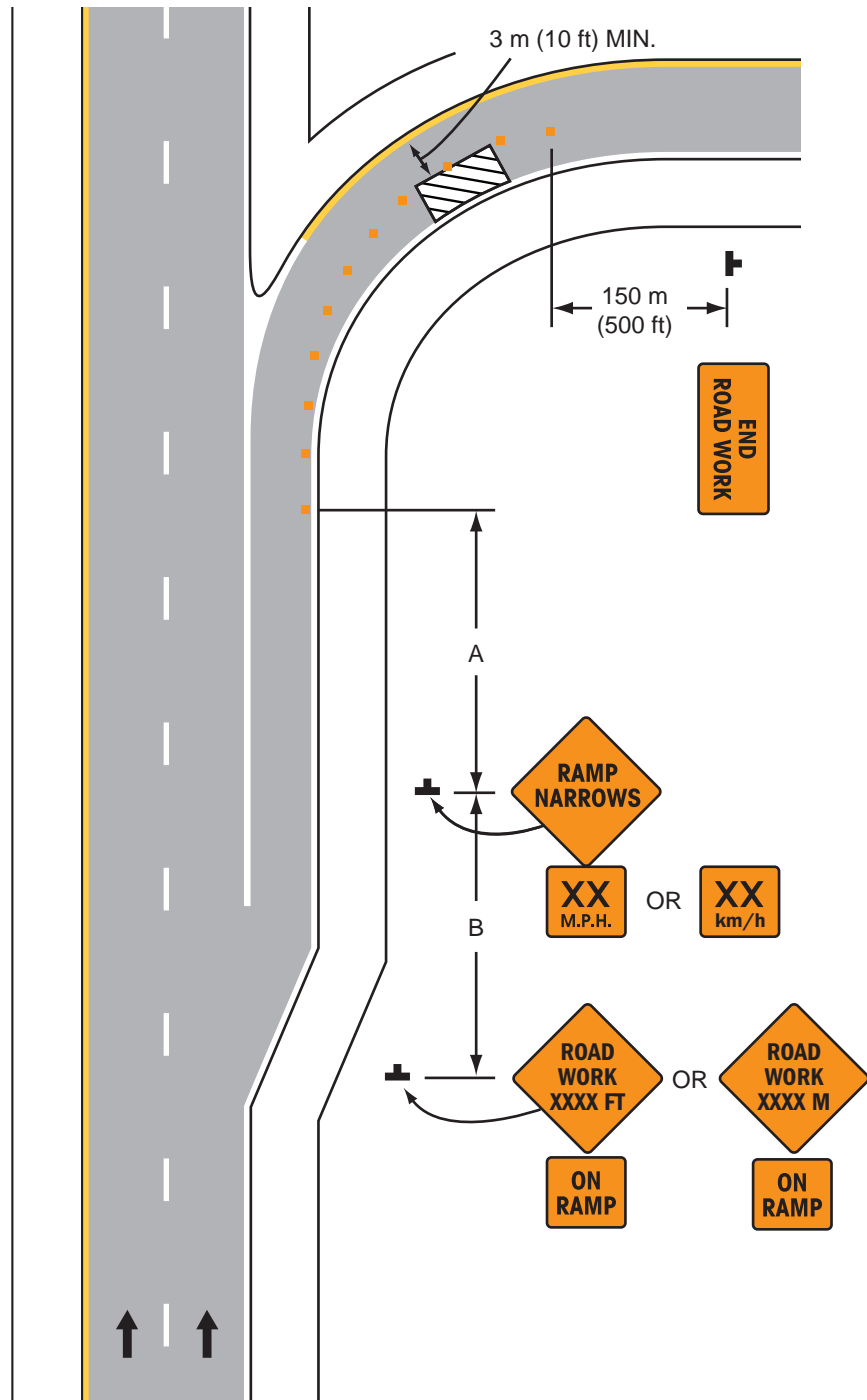

Typical Application 43

Note: See Tables 6H-2 and 6H-3 for the meaning of the symbols and/or letter codes used in this figure.

Notes for Figure 6H-44 – Typical Application 44

Work in Vicinity of Entrance Ramp

Guidance:

1. An acceleration lane of sufficient length should be provided whenever possible as shown on the left diagram.

Standard:

2. **For the information shown on the right diagram of the typical application, where inadequate acceleration distance exists for the temporary entrance, the YIELD sign shall be replaced with STOP signs (one on each side of the approach).**

Guidance:

3. When used, the YIELD or STOP sign should be located so that ramp motor vehicle traffic has adequate sight distance of oncoming mainline motor vehicle traffic to select a safe gap in the mainline motor vehicle traffic flow. Also, a longer acceleration lane should be provided beyond the sign to reduce the gap size needed. If insufficient gaps are available, consideration should be given to closing the ramp.
4. Where STOP signs are used, a temporary stop line should be placed across the ramp at the desired stop location.
5. The right lane should be closed sufficiently in advance to stabilize motor vehicle traffic flow before encountering the merge.
6. The mainline merging taper with the arrow panel at its starting point should be located sufficiently in advance so that the arrow panel is not confusing to drivers on the entrance ramp, and so that the mainline merging motor vehicle traffic from the lane closure has the opportunity to stabilize before encountering the motor vehicle traffic merging from the ramp.
7. If the ramp curves sharply to the right, warning signs with Advisory Speed Limits located in advance of the entrance terminal should be placed in pairs (one on each side of the ramp).

Option:

8. A Type B High-Intensity warning flasher with a red lens may be placed above the STOP sign.
9. Where the acceleration distance is significantly reduced, a supplemental plaque may be placed below the YIELD AHEAD sign reading NO MERGE AREA.

Figure 6H-44. Work in Vicinity of Entrance Ramp (TA-44)

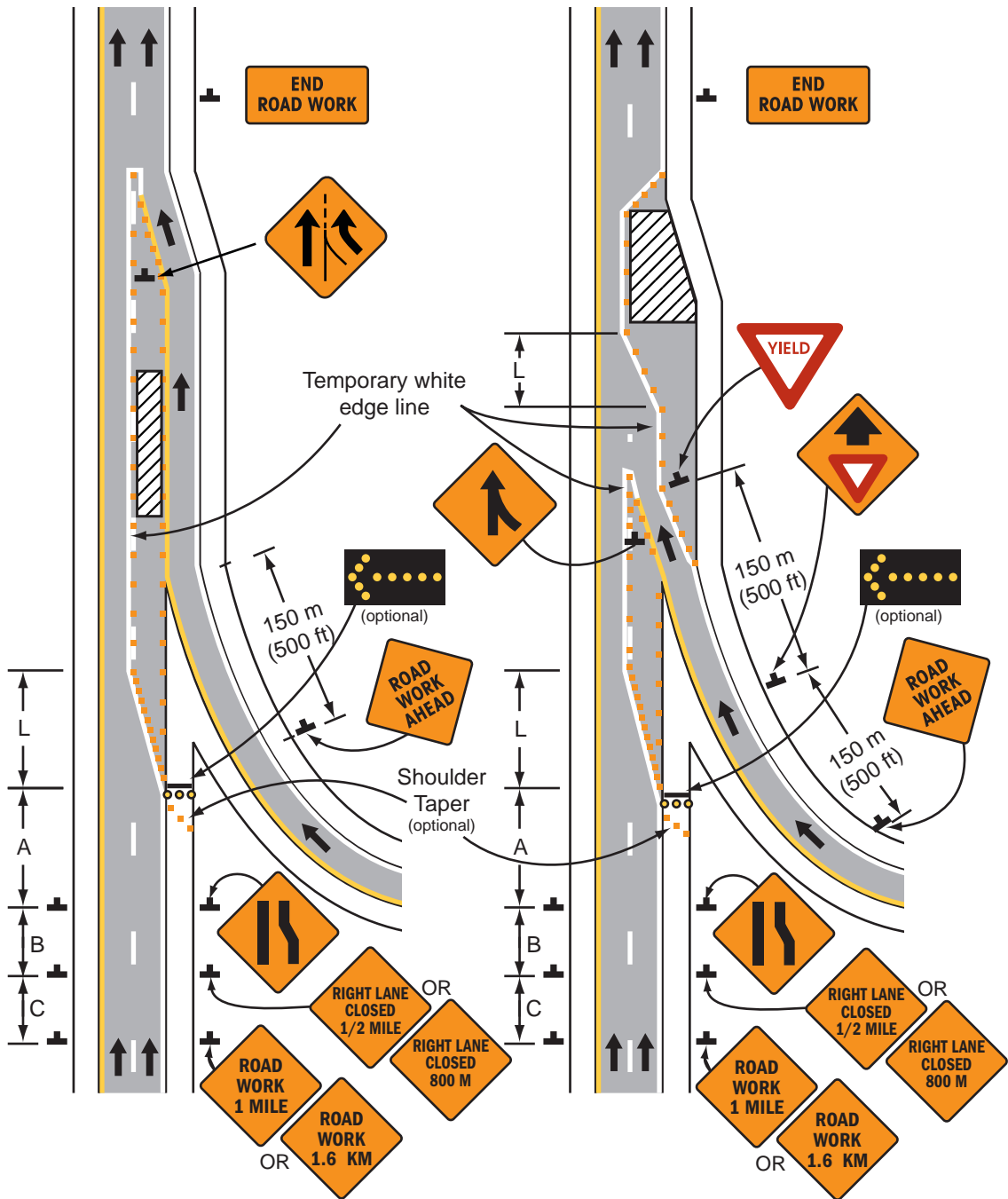

Typical Application 44

Note: See Tables 6H-2 and 6H-3 for the meaning of the symbols and/or letter codes used in this figure.

Notes for Figure 6H-45 – Typical Application 45

Temporary Reversible Lane Using Movable Barriers

Support:

1. This application addresses one of several uses for movable barriers in highway work zones. In this example, one side of a 6-lane divided highway is closed to perform the work operation, and motor vehicle traffic is carried in both directions on the remaining 3-lane roadway by means of a median crossover. To accommodate unbalanced peak-period motor vehicle traffic volumes, the direction of travel in the center lane is switched to the direction having the greater volume, with the transfer typically being made twice daily. Thus, there are four motor vehicle traffic phases described as follows:
 - a. Phase A - two travel lanes northbound and one lane southbound.
 - b. Transition A to B - one travel lane in each direction.
 - c. Phase B - one travel lane northbound and two lanes southbound.
 - d. Transition B to A - one travel lane in each direction.

The typical application on the left illustrates the placement of devices during Phase A. The typical application on the right shows conditions during the transition (Transition A to B) from Phase A to Phase B.

Guidance:

2. For the reversible-lane situation depicted, the ends of the movable barrier should terminate in a protected area or a crash cushion should be provided. During Phase A, the transfer vehicle should be parked behind the end of the movable barrier. During Phase B, the transfer vehicle should be parked behind the end of the movable barrier.

The transition shift from Phase A to B should be as follows:

- a. Change the signs in the northbound advance warning area and transition area from a LEFT LANE CLOSED AHEAD to a LEFT TWO LANES CLOSED AHEAD.
 - b. Place channelizing devices to close the northbound center lane.
 - c. Move the transfer vehicle from south to north to shift the movable barrier from the west side to the east side of the reversible lane.
 - d. Remove the channelizing devices closing the southbound center lane.
 - e. Change the signs in the southbound transition area and advance warning area from a LEFT TWO LANES CLOSED AHEAD to LEFT LANE CLOSED AHEAD.
3. Where the lane to be opened and closed is an exterior lane (adjacent to the edge of the traveled way or the work space), the lane shift should begin by closing the lane with channelizing devices placed along a merging taper using the same information employed for a stationary lane closure. The lane closure should then be extended with the movable-barrier transfer vehicle moving with motor vehicle traffic. When opening the lane, the transfer vehicle should travel against motor vehicle traffic. The merging taper should be removed in a method similar to a stationary lane closure.

Figure 6H-45. Movable Barriers (TA-45)

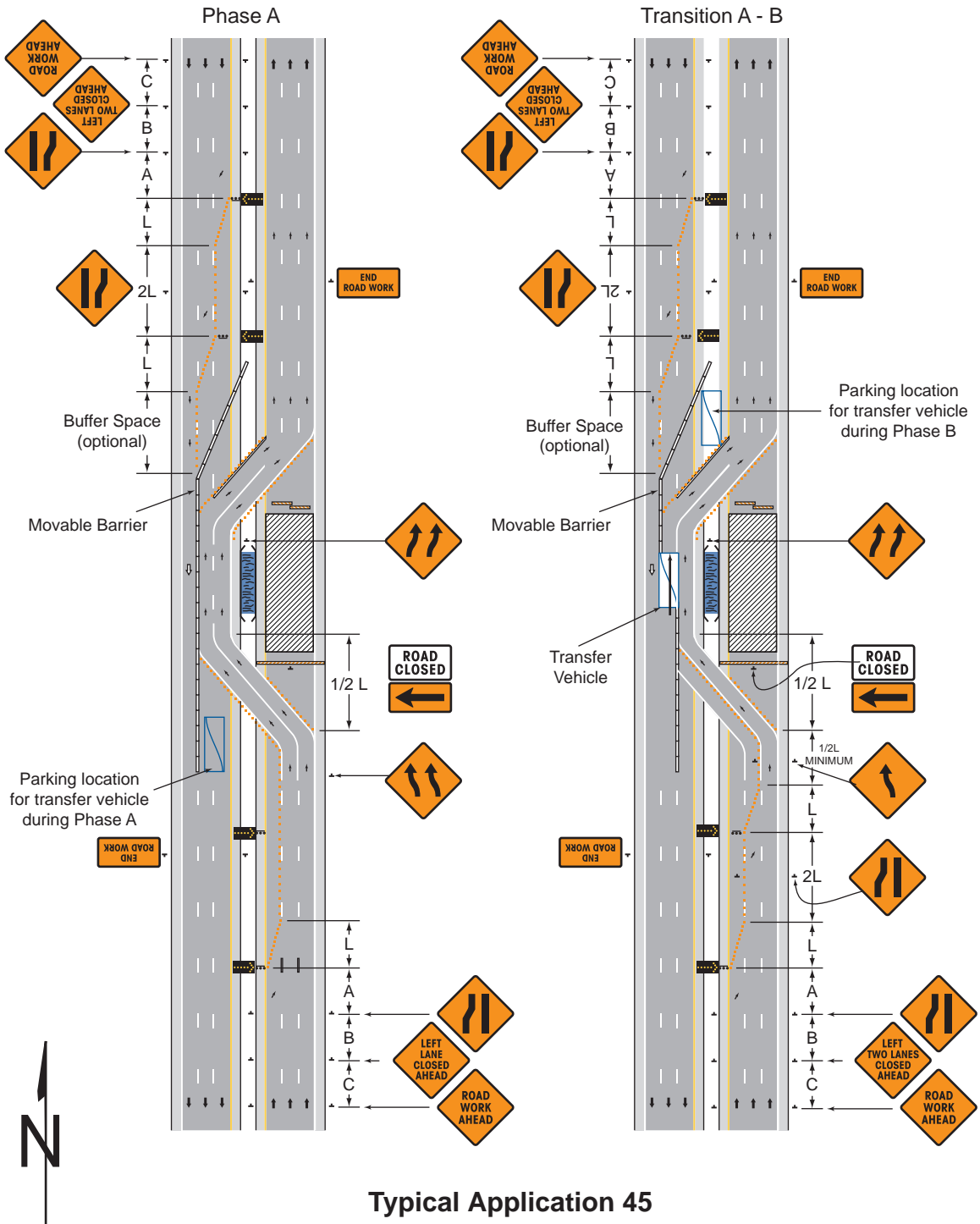

Note: See Tables 6H-2 and 6H-3 for the meaning of the symbols and/or letter codes used in this figure.

Note: Although leader lines point to signs on the right side of roadway, most signs should be installed on both sides of roadway.

Notes for Figure 6H-46 – Typical Application 46

Work in Vicinity of Highway-Rail Grade Crossing

Guidance:

1. When highway-rail grade crossings exist either within or in the vicinity of roadway work activities, extra care should be taken to minimize the probability of conditions being created, either by lane restrictions, flagging or other operations, where vehicles might be stopped within the highway-rail grade crossing, considered as being 4.5 m (15 ft) on either side of the closest and farthest rail.

Standard:

- 2. If the queuing of vehicles across active rail tracks cannot be avoided, a law enforcement officer or flagger shall be provided at the highway-rail grade crossing to prevent vehicles from stopping within the highway-rail grade crossing (as described in Note 1), even if automatic warning devices are in place.**

Guidance:

3. Early coordination with the railroad company should occur before work starts.
4. In the example depicted, the buffer space of the activity area should be extended upstream of the highway-rail grade crossing (as shown) so that a queue created by the flagging operation will not extend across the highway-rail grade crossing.
5. The DO NOT STOP ON TRACKS sign should be used on all approaches to a highway-rail grade crossing within the limits of a temporary traffic control zone.

Option:

6. Flashing warning lights and/or flags may be used to call attention to the advance warning signs.
7. A BE PREPARED TO STOP sign may be added to the sign series.

Guidance:

8. When used, the BE PREPARED TO STOP sign should be located before the Flagger symbol sign.
9. Lighting should be provided as needed to adequately illuminate flagger stations at night.

Figure 6H-46. Work in Vicinity of Highway-Rail Grade-Crossing (TA-46)

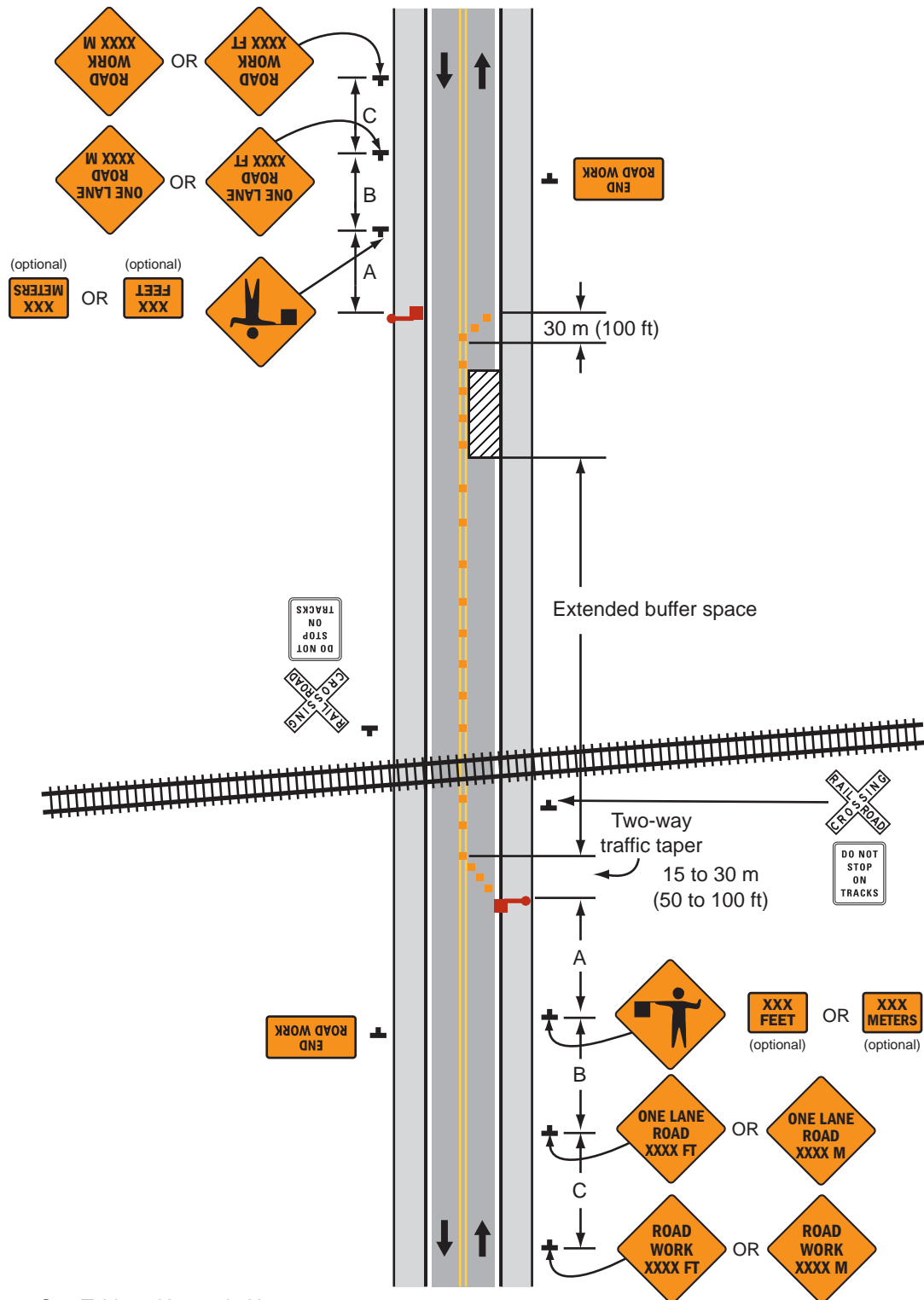

Note: See Tables 6H-2 and 6H-3 for the meaning of the symbols and/or letter codes used in this figure.

Typical Application 46



PART 7

Traffic Controls for School Areas

MUTCD 2000

Manual on Uniform Traffic Control Devices

m i l l e n n i u m e d i t i o n

December 2000



U.S. Department
of Transportation

**Federal Highway
Administration**

PART 7. TRAFFIC CONTROLS FOR SCHOOL AREAS**TABLE OF CONTENTS**

	<u>Page</u>
CHAPTER 7A. GENERAL	Dec., 2000
Section 7A.01	Need for Standards7A-1
Section 7A.02	School Routes and Established School Crossings7A-3
Section 7A.03	School Crossing Control Criteria7A-3
Section 7A.04	Scope7A-4
Section 7A.05	Application of Standards7A-4
Section 7A.06	Engineering Study Required7A-4
Section 7A.07	Maintenance of Traffic Control Devices7A-4
Section 7A.08	Placement Authority7A-5
Section 7A.09	Removal of Confusing Advertising7A-5
Section 7A.10	Meaning of Standard, Guidance, Option, and Support7A-5
CHAPTER 7B. SIGNS	Dec., 2000
Section 7B.01	Size of School Signs7B-1
Section 7B.02	Illumination and Reflectorization7B-1
Section 7B.03	Position of Signs7B-1
Section 7B.04	Height of Signs7B-3
Section 7B.05	Installation of Signs7B-3
Section 7B.06	Lettering7B-3
Section 7B.07	Sign Color for School Warning Signs7B-3
Section 7B.08	School Advance Warning Sign (S1-1)7B-4
Section 7B.09	School Crosswalk Warning Assembly (S1-1 with Diagonal Arrow) ..7B-4
Section 7B.10	SCHOOL BUS STOP AHEAD Sign (S3-1)7B-7
Section 7B.11	School Speed Limit Assembly (S4-1, S4-2, S4-3, S4-4, S5-1)7B-7
Section 7B.12	School Reduced Speed Ahead Assembly7B-8
Section 7B.13	END SCHOOL ZONE Sign (S5-2)7B-9
Section 7B.14	Parking and Stopping Signs (R7 and R8 Series)7B-9
CHAPTER 7C. MARKINGS	Dec., 2000
Section 7C.01	Functions and Limitations7C-1
Section 7C.02	Standardization of Application7C-1
Section 7C.03	Crosswalk Markings7C-1
Section 7C.04	Stop Line Markings7C-2
Section 7C.05	Curb Markings for Parking Regulations7C-2
Section 7C.06	Pavement Word and Symbol Markings7C-3

CHAPTER 7D. SIGNALSDec., 2000

Section 7D.01 General7D-1

CHAPTER 7E. CROSSING SUPERVISIONDec., 2000

Section 7E.01 Types of Crossing Supervision7E-1

Section 7E.02 Adult Guards7E-1

Section 7E.03 Qualifications of Adult Guards7E-1

Section 7E.04 Uniform of Adult Guards and Student Patrols7E-2

Section 7E.05 Operating Procedures for Adult Guards7E-2

Section 7E.06 Police Officers7E-2

Section 7E.07 Student Patrols7E-3

Section 7E.08 Choice of Student Patrols7E-3

Section 7E.09 Operating Procedures for Student Patrols7E-3

CHAPTER 7F. GRADE-SEPARATED CROSSINGSDec., 2000

Section 7F.01 Function7F-1

Section 7F.02 Types of Grade-Separated Crossings7F-1

Section 7F.03 Criteria for Use of Grade-Separated Crossings7F-1

FIGURES

CHAPTER 7A. GENERAL

Figure 7A-1 Typical School Route Plan Map7A-2

CHAPTER 7B. SIGNS

Figure 7B-1 Typical Signing for School Area Traffic Control7B-6

CHAPTER 7C. MARKINGS

Figure 7C-1 Two-Lane Pavement Marking of "SCHOOL"7C-4

TABLES

CHAPTER 7B. SIGNS

Table 7B-1 Size of School Area Signs and Plaques7B-2

CHAPTER 7A. GENERAL

Section 7A.01 Need for Standards

Support:

It is important to stress that regardless of the school location, the best way to achieve safe and effective traffic control is through the uniform application of realistic policies, practices, and standards developed through engineering judgment.

Pedestrian safety depends upon public understanding of accepted methods for efficient traffic control. This principle is especially important in the control of pedestrians, bicycles and other vehicles in the vicinity of schools. Neither school pedestrians nor road users can be expected to move safely in school areas unless they understand both the need for traffic controls and how these controls function for their benefit.

Procedures and devices that are not uniform might cause confusion among pedestrians and road users, prompt wrong decisions, and contribute to crashes. To achieve uniformity of traffic control in school areas, comparable traffic situations need to be treated in a consistent manner. Each traffic control device and control method described in Part 7 fulfills a specific function related to specific traffic conditions.

A uniform approach to school area traffic controls assures the use of similar controls for similar situations (which promotes uniform behavior on the part of drivers, pedestrians, and bicyclists).

A school traffic control plan permits the orderly review of school area traffic control needs, and the coordination of school/pedestrian safety education and engineering activities.

Guidance:

A school route plan for each school serving elementary to high school students should be prepared in order to develop uniformity in the use of school area traffic controls and to serve as the basis for a school traffic control plan for each school.

The school route plan, developed in a systematic manner by the school, law enforcement, and traffic officials responsible for school pedestrian safety, should consist of a map showing streets, the school, existing traffic controls, established school walk routes, and established school crossings. A typical school route plan map is shown in Figure 7A-1.





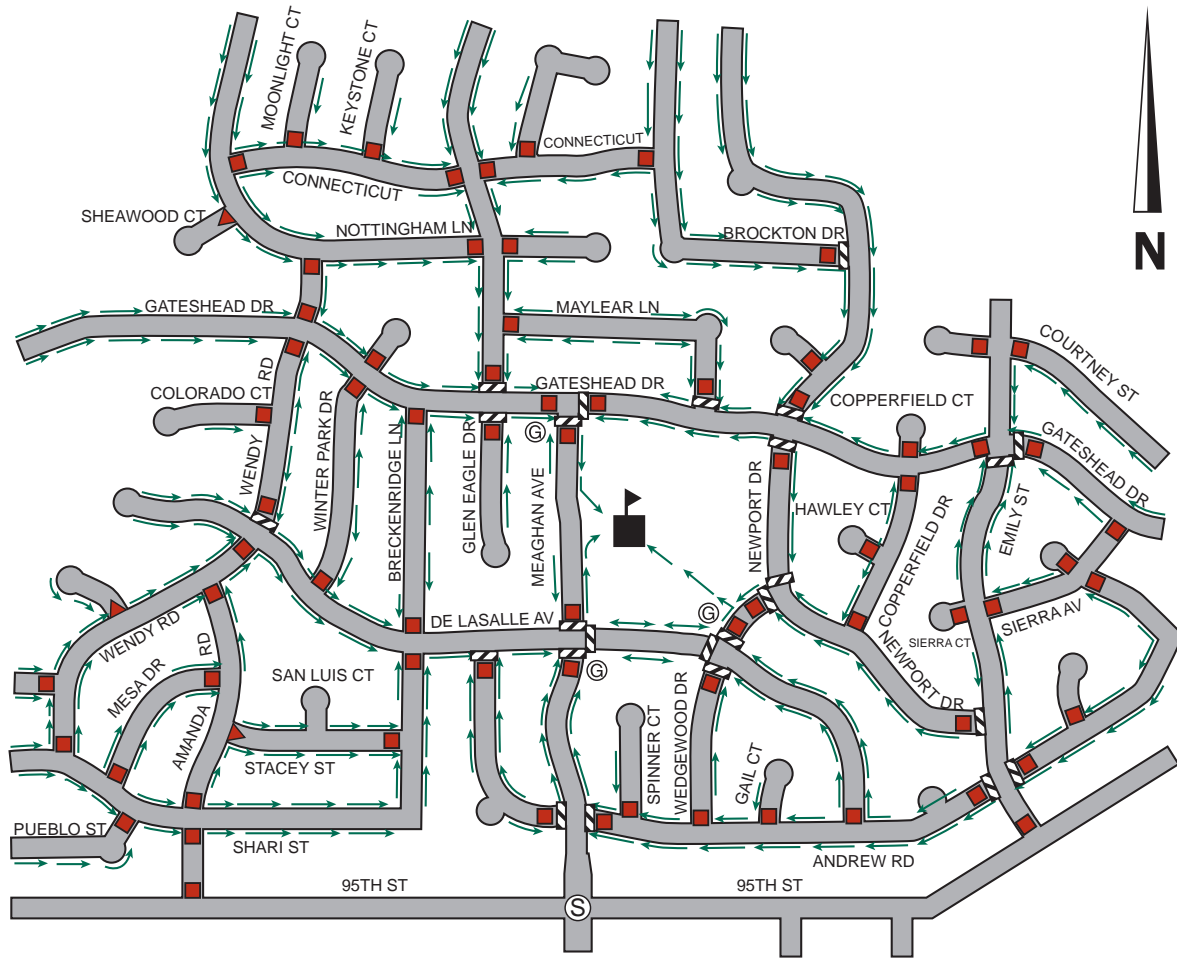

Standard:

The type(s) of school area traffic control devices used, either warning or regulatory, shall be related to the volume and speed of vehicular traffic, street width, and the number and age of the students using the crossing.

Figure 7A-1. Typical School Route Plan Map



Legend

- | | | | |
|---|------------------|---|-------------------------|
|  | School |  | Signalized Intersection |
|  | Marked Crosswalk |  | STOP Sign Approach |
|  | Crossing Guard |  | YIELD Sign Approach |
| | |  | Pedestrian Route |

Guidance:

School area traffic control devices should be included in a school traffic control plan.

Support:

Reduced speed limit signs for school areas and crossings are included in this Manual solely for the purpose of standardizing signing for these zones and not as an endorsement of mandatory reduced speed zones.

Section 7A.02 School Routes and Established School Crossings**Support:**

The planning criterion for school walk routes might make it necessary for children to walk an indirect route to an established school crossing located where there is existing traffic control and to avoid the use of a direct crossing where there is no existing traffic control.

Guidance:

School walk routes should be planned to take advantage of existing traffic controls.

The following factors should be considered when determining the feasibility of requiring children to walk a longer distance to a crossing with existing traffic control:

- A. The availability of adequate sidewalks or off-roadway sidewalk areas to and from the location with existing control,
- B. The number of students using the crossing,
- C. The age levels of the students using the crossing, and
- D. The total extra walking distance.

Section 7A.03 School Crossing Control Criteria**Support:**

Alternate gaps and blockades are inherent in the traffic stream and are different at each crossing location. For safety, students need to wait for a gap in traffic that is of sufficient duration to permit reasonably safe crossing. When the delay between the occurrence of adequate gaps becomes excessive, students might become impatient and endanger themselves by attempting to cross the street during an inadequate gap.

A recommended method for determining the frequency and adequacy of gaps in the traffic stream is given in the Institute of Transportation Engineers' publication, "School Trip Safety Program Guidelines" (see Section 1A.11).

Section 7A.04 Scope

Standard:

Part 7 sets forth basic principles and prescribes standards that shall be followed in the design, application, installation, and maintenance of all traffic control devices and other controls required for the special pedestrian conditions in school areas. Such devices and controls include signs, signals, markings, adult crossing guards, student patrols, and grade-separated crossings.

Portable school signs shall not be used.

Support:

Requirements discussed in Chapter 2A and Section 2B.05 are applicable in school areas.

Section 7A.05 Application of Standards

Support:

Sections 1A.02 and 1A.07 contain information regarding the application of standards.

Section 7A.06 Engineering Study Required

Support:

Section 1A.09 contains information regarding engineering studies.

Section 7A.07 Maintenance of Traffic Control Devices

Support:

Section 1A.05 contains information regarding the maintenance of traffic control devices.

Section 7A.08 Placement Authority

Support:

Section 1A.08 contains information regarding placement authority for traffic control devices.

Section 7A.09 Removal of Confusing Advertising

Support:

Section 1A.08 contains information regarding the removal of confusing advertising.

Section 7A.10 Meaning of Standard, Guidance, Option, and Support

Support:

The introduction to this Manual contains information regarding the meaning of the headings Standard, Guidance, Option, and Support, and the use of the words shall, should, and may.

CHAPTER 7B. SIGNS

Section 7B.01 Size of School Signs

Standard:

The sizes of signs and plaques to be used on conventional roadways in school areas shall be as shown in Table 7B-1.

The Standard sign size shall be used on public roads, streets, and highways unless engineering judgment determines that a Special sign size would be more appropriate.

The Special sign size shall be used on expressways.

Option:

The Special sign size may be used for applications that require increased emphasis, improved recognition, or increased legibility.

The Minimum sign size may be used on local residential streets, in urban areas, and where there are low traffic volumes and low vehicle speeds, as determined by engineering judgment.

Section 7B.02 Illumination and Reflectorization

Standard:

The signs used for school area traffic control shall be retroreflectorized or illuminated.

Section 7B.03 Position of Signs

Guidance:

Signs should be placed in positions where they will convey their messages most effectively without restricting lateral clearance or sight distances. Placement therefore should consider highway design, alignment, vehicle speed, and roadside development.

Signs should have a maximum practical clearance from the edge of the traveled way for the safety of vehicles that might leave the roadway and strike the sign supports. Except as noted in the Option, signs should not be closer than 1.8 m (6 ft) from the edge of a paved shoulder, or if none, 3.7 m (12 ft) from the edge of the traveled way.

Table 7B-1. Size of School Area Signs and Plaques

Sign	MUTCD Code	Conventional Roads		
		Minimum	Standard	Special
School Crossing	S1-1	750 x 750 mm (30 x 30 in)	900 x 900 mm (36 x 36 in)	1200 x 1200 mm (48 x 48 in)
School Bus Stop Ahead	S3-1	750 x 750 mm (30 x 30 in)	750 x 750 mm (30 x 30 in)	900 x 900 mm (36 x 36 in)
End School Zone	S5-2	600 x 750 mm (24 x 30 in)	600 x 750 mm (24 x 30 in)	900 x 1200 mm (36 x 48 in)
Speed Limit (School Use)	R2-1	600 x 750 mm (24 x 30 in)	600 x 750 mm (24 x 30 in)	900 x 1200 mm (36 x 48 in)

Plaque	MUTCD Code	Conventional Roads		
		Minimum	Standard	Special
8:30 AM TO 5:30 PM	S4-1	600 x 250 mm (24 x 10 in)	900 x 375 mm (36 x 15 in)	1200 x 500 mm (48 x 20 in)
When Children Are Present	S4-2	600 x 250 mm (24 x 10 in)	900 x 500 mm (36 x 20 in)	1200 x 750 mm (48 x 30 in)
School	S4-3	600 x 200 mm (24 x 8 in)	900 x 300 mm (36 x 12 in)	1200 x 400 mm (48 x 16 in)
When Flashing	S4-4	600 x 250 mm (24 x 10 in)	900 x 375 mm (36 x 15 in)	1200 x 500 mm (48 x 20 in)
XXX Feet	W16-2	600 x 450 mm (24 x 18 in)	750 x 600 mm (30 x 24 in)	750 x 600 mm (30 x 24 in)
XXX Feet	W16-2a	600 x 300 mm (24 x 12 in)	750 x 450 mm (30 x 18 in)	750 x 450 mm (30 x 18 in)
Ahead	W16-9p	600 x 250 mm (24 x 10 in)	900 x 500 mm (36 x 20 in)	1200 x 750 mm (48 x 30 in)
Diagonal Arrow	W16-7	600 x 300 mm (24 x 12 in)	750 x 450 mm (30 x 18 in)	750x 450 mm (30 x 18 in)
Metric	R2-6p	600 x 250 mm (24 x 10 in)	900 x 500 mm (36 x 20 in)	1200 x 750 mm (48 x 30 in)

Option:

In urban areas, a lesser clearance of not less than 0.6 m (2 ft) from the face of the curb may be used. In urban areas, where sidewalk width is limited or existing poles are close to the curb, a clearance of 0.3 m (1 ft) from the curb face may be used.

Section 7B.04 Height of Signs**Support:**

Section 2A.18 contains information regarding the mounting height of signs.

Section 7B.05 Installation of Signs**Support:**

Section 2A.21 contains information regarding the installation of signs.

Section 7B.06 Lettering**Support:**

The "Standard Alphabets for Highway Signs and Pavement Markings" contains information regarding sign lettering.

Section 7B.07 Sign Color for School Warning Signs**Standard:**

Except as noted in the Option, school warning signs shall have a yellow background with a black legend and border unless specifically designed otherwise.

Option:

The following signs may have a fluorescent yellow-green background with a black legend and border:

- A. School Crossing sign (S1-1),
- B. School Bus Stop Ahead sign (S3-1),
- C. SCHOOL plaque (S4-3),
- D. School Speed Limit sign (S5-1),

- E. XXX FEET plaque (W16-2 series),
- F. AHEAD plaque (W16-9p), and
- G. Diagonal Arrow plaque (W16-7).

Guidance:

When the fluorescent yellow-green background color is used, a systematic approach featuring one background color within a zone or area should be used. The mixing of standard yellow and fluorescent yellow-green backgrounds within a zone or area should be avoided.

Section 7B.08 School Advance Warning Sign (S1-1)

Standard:

The School Advance Warning (S1-1) sign shall be used in advance of any installation of the School Crossing sign.

If used, the School Advance Warning sign shall be installed not less than 45 m (150 ft) nor more than 210 m (700 ft) in advance of the school grounds or school crossings (see Figure 7B-1).

The School Advance Warning sign shall be used in advance of the first installation of the School Speed Limit sign assembly.

If used, the School Advance Warning sign shall be supplemented with a supplemental plaque with the legend AHEAD (W16-9p) or XXX METERS (XXX FEET) (W16-2 or W16-2a) to provide advance notice to road users of crossing activity.

Guidance:

The School Advance Warning (S1-1) sign should be installed in advance of locations where school buildings or grounds are adjacent to the highway.

Section 7B.09 School Crosswalk Warning Assembly (S1-1 with Diagonal Arrow)

Standard:

If used, the School Crosswalk Warning assembly shall be installed at the marked crosswalk, or as close to it as possible, and shall consist of a School



S1-1



W16-9p

OR



W16-2

OR



W16-2a

OR



OR



S1-1



W16-7

School Crosswalk
Warning Assembly



S3-1



S4-3

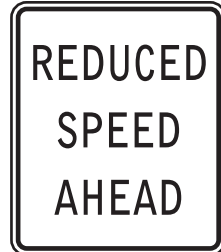

S2-5a

School Reduced
Speed Ahead
Assembly



S4-3



R2-1

OR



S4-1

OR



S4-2

OR



S4-4

School Speed Limit
Assembly



R2-6P



S4-3



R2-1



S4-1



S5-1

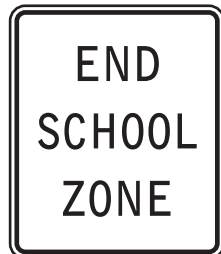

S5-2

Figure 7B-1. Typical Signing for School Area Traffic Control

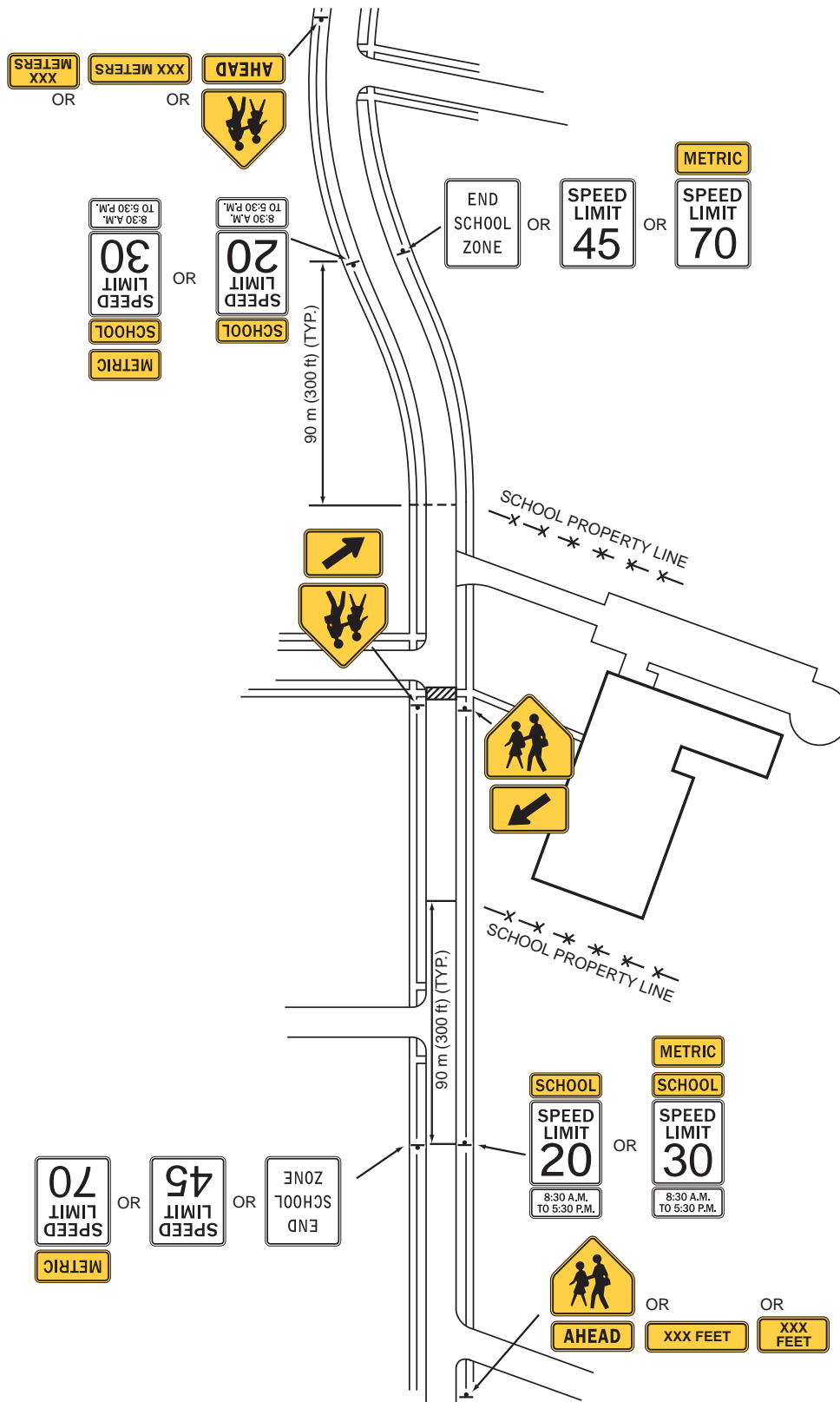

Advance Warning (S1-1) sign supplemented with a diagonal downward pointing arrow (W16-7) plaque to show the location of the crossing.

The School Crosswalk Warning assembly shall not be used at marked crosswalks other than those adjacent to schools and those on established school pedestrian routes.

The School Crosswalk Warning assembly shall not be installed on approaches controlled by a STOP sign.

Guidance:

The School Crosswalk Warning assembly should be installed at marked crosswalk(s), including those at signalized locations, used by students going to and from school (see Figure 7B-1) as determined by an engineering study.

Section 7B.10 SCHOOL BUS STOP AHEAD Sign (S3-1)

Guidance:

The SCHOOL BUS STOP AHEAD (S3-1) sign should be installed in advance of locations where a school bus, when stopped to pick up or discharge passengers, is not visible for a distance of 150 m (500 ft) in advance and where there is no opportunity to relocate the bus stop to provide 150 m (500 ft) of visibility.

Section 7B.11 School Speed Limit Assembly (S4-1, S4-2, S4-3, S4-4, S5-1)

Standard:

A School Speed Limit assembly or a School Speed Limit (S5-1) sign shall be used to indicate the speed limit where a reduced speed zone for a school area has been established (in accordance with law based upon an engineering study) or where a speed limit is specified for such areas by statute. The School Speed Limit assembly or School Speed Limit sign shall be placed at or as near as practical to the point where the reduced speed zone begins.

Guidance:

The reduced speed zone should begin at a point either 60 m (200 ft) from the crosswalk, or 90 m (300 ft) from the school property line, whichever is encountered first as traffic approaches the school.

Standard:

The School Speed Limit assembly shall be either a fixed-message sign assembly or a changeable message sign.

The fixed-message School Speed Limit assembly shall consist of a top plaque (S4-3) with the legend SCHOOL, a Speed Limit (R2-1) sign, and a bottom plaque (S4-1, S4-2, or S4-4) indicating the specific periods of the day and/or days of the week that the special school speed limit is in effect.

Guidance:

Even though it might not always be practical because of special features to make changeable message signs conform in all respects to the accepted standards, during the periods that the school speed limit is in effect, their basic shape, message, legend layout, and colors should conform to the standards for fixed-message signs.

A confirmation beacon or device to indicate that the speed limit message is in operation should be considered for inclusion on the back of the changeable message sign.

Option:

Changeable message signs may be used to inform drivers of the special school speed limit. If the sign is internally illuminated, it may have a white legend on a black background. Changeable message signs with flashing beacons may be used for the more critical situations, where greater emphasis of the special school speed limit is needed.

Changeable message signs may use blank-out messages or other methods in order to display the school speed limit only during the periods it applies.

A Speed Limit Sign Beacon also may be used, with a WHEN FLASHING legend, to identify the periods that the school speed limit is in effect. The lenses of the Speed Limit Sign Beacon may be positioned within the face of the School Speed Limit (S5-1) sign.

Section 7B.12 School Reduced Speed Ahead Assembly

Option:

The School Reduced Speed Ahead assembly may be used to inform the road users of a reduced speed zone when engineering judgment indicates that advance notice would be appropriate.

Standard:

If used, the School Reduced Speed Ahead assembly shall consist of the REDUCED SPEED AHEAD (R2-5a) sign in combination with the SCHOOL (S4-3) plaque mounted above it.

If used, the School Reduced Speed Ahead assembly shall be followed by a School Speed Limit sign or a School Speed Limit assembly.

Section 7B.13 END SCHOOL ZONE Sign (S5-2)**Standard:**

The end of an authorized and posted school speed zone shall be marked with a standard Speed Limit sign showing the speed limit for the section of highway that follows or with an END SCHOOL ZONE (S5-2) sign.

Section 7B.14 Parking and Stopping Signs (R7 and R8 Series)

Option:

Parking and stopping regulatory signs may be used to prevent parked or waiting vehicles from blocking pedestrians' views, and drivers' views of pedestrians, and to control vehicles as a part of the school traffic plan.

Support:

Parking signs and other signs governing the stopping and standing of vehicles in school areas cover a wide variety of regulations. Typical examples of regulations are as follows:

- A. No Parking 8:00 AM to 5:00 PM School Days Only.
- B. No Stopping 8:00 AM to 5:00 PM School Days Only.
- C. 5 Min Loading 8:00 AM to 5:00 PM School Days Only.
- D. No Standing 8:00 AM to 5:00 PM School Days Only.

Sections 2B.34, 2B.35, and 2B.36 contain information regarding the signing of parking regulations in school zone areas.

CHAPTER 7C. MARKINGS

Section 7C.01 Functions and Limitations

Support:

Markings have definite and important functions in a proper scheme of school area traffic control. In some cases, they are used to supplement the regulations or warnings provided by other devices, such as traffic signs or signals. In other instances, they are used alone and produce results that cannot be obtained by the use of any other device. In such cases they serve as an effective means of conveying certain regulations, guidance, and warnings that could not otherwise be made clearly understandable.

Pavement markings have limitations. They might be obliterated by snow, might not be clearly visible when wet, and might not be durable when subjected to heavy traffic. In spite of these limitations, they have the advantage, under favorable conditions, of conveying warnings or information to the road user without diverting attention from the road.

Section 7C.02 Standardization of Application

Standard:

Each standard marking shall be used only to convey the meaning prescribed for it in this Manual.

Section 7C.03 Crosswalk Markings

Standard:

When transverse crosswalk lines are used, they shall be solid white, marking both edges of the crosswalk, except as noted in the Option. They shall be not less than 150 mm (6 in) nor greater than 600 mm (24 in) in width.

Guidance:

Crosswalk lines should not be spaced less than 1.8 m (6 ft) apart.

Crosswalk lines on both sides of the crosswalk should extend across the full width of pavement to discourage diagonal walking between crosswalks.

Crosswalks should be marked at all intersections on established routes to school where there is substantial conflict between drivers, bicyclists, and pedestrian movements, where students are encouraged to cross between intersections, or where students would not otherwise recognize the proper place to cross.

Option:

For added visibility, the area of the crosswalk may be marked with white diagonal lines at a 45-degree angle to the line of the crosswalk or with white longitudinal lines parallel to traffic flow. When diagonal or longitudinal lines are used to mark a crosswalk, the transverse crosswalk lines may be omitted.

Guidance:

The diagonal or longitudinal lines should be 300 to 600 mm (12 to 24 in) wide and spaced 300 to 600 mm (12 to 24 in) apart. The spacing design should avoid the wheel paths.

Section 7C.04 Stop Line Markings**Standard:**

Stop lines are solid white lines extending across approach lanes to indicate the point at which the stop is intended or required to be made.

Guidance:

Stop lines should be 300 to 600 mm (12 to 24 in) wide. Stop lines should be used to indicate the point behind which vehicles are required to stop, in compliance with a STOP sign or traffic signal. Stop lines, if used, should be placed 1.2 m (4 ft) in advance of the nearest crosswalk line, except at roundabouts as provided for in Section 3B.24. In the absence of a marked crosswalk, the stop line should be placed at the desired stopping point, but should be placed no more than 9 m (30 ft) nor less than 1.2 m (4 ft) from the nearest edge of the intersecting traveled way.

Stop lines should be placed to ensure sufficient sight distance for all approaches to an intersection. Stop lines at mid-block signalized locations should be placed at least 12 m (40 ft) in advance of the nearest signal indication (see Section 4D.15).

Section 7C.05 Curb Markings for Parking Regulations**Standard:**

Signs shall be used with curb markings in those areas where curb markings are frequently obliterated by snow and ice accumulation, unless the no parking zone is controlled by statute or local ordinance.

Guidance:

When curb markings are used without signs to convey parking regulations, a legible word marking regarding the regulation (such as "No Parking" or "No Standing") should be placed on the curb.

Option:

Local authorities may prescribe special colors for curb markings to supplement standard signs for parking regulation.

Support:

Since yellow and white curb markings are frequently used for curb delineation and visibility, it is advisable to establish parking regulations through the installation of standard signs (see Sections 2B.34 through 2B.36).

Section 7C.06 Pavement Word and Symbol Markings**Support:**

Word and symbol markings on the pavement are used for the purpose of guiding, warning, or regulating traffic.

Standard:

Word and symbol markings shall be white. Word and symbol markings shall not be used for mandatory messages except in support of standard signs.

Guidance:

Large letters and numerals should be 1.8 m (6 ft) or more in height. All letters, numerals, and symbols should be in accordance with the "Standard Alphabets for Highway Signs and Pavement Markings."

Word and symbol markings should not exceed three lines of information.

If a pavement marking word message consists of more than one line of information, it should read in the direction of travel. The first word of the message should be nearest to the road user.

The longitudinal space between word or symbol message markings, including arrow markings, should be at least four times the height of the characters for low speed roads, but not more than ten times the height of the characters under any conditions.

Except as noted in the Option, pavement word and symbol markings should be no more than one lane in width.

Option:

The SCHOOL word marking may extend to the width of two approach lanes (see Figure 7C-1).

Guidance:

If the two-lane SCHOOL word marking is used, the letters should be 3 m (10 ft) or more in height.

Figure 7C-1. Two-Lane Pavement Marking of "SCHOOL"

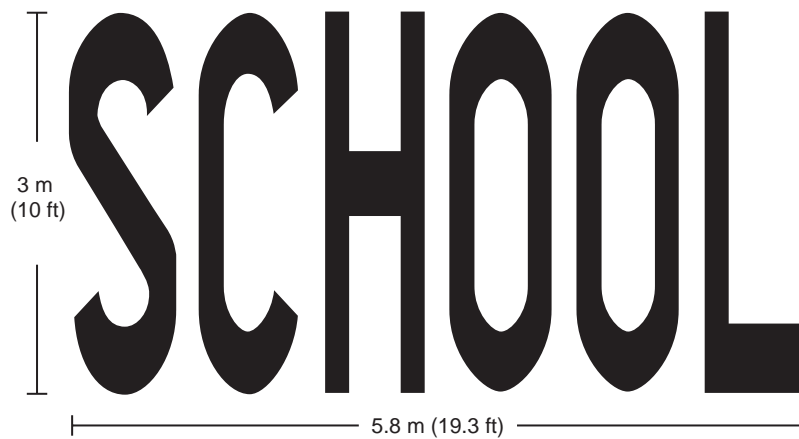

CHAPTER 7D. SIGNALS

Section 7D.01 General

Support:

Part 4 contains information regarding highway traffic signals in school areas. The School Crossing signal warrant is described in Section 4C.06.

CHAPTER 7E. CROSSING SUPERVISION

Section 7E.01 Types of Crossing Supervision

Support:

There are two types of school crossing supervision:

- A. Adult control of pedestrians and vehicles by adult guards or police officers.
- B. Student control of only pedestrians with student patrols.

Information for the organization, operation and administration of an adult crossing guard program are given in "Civilian Guards For School Crossings" (available from the Traffic Institute of Northwestern University, 405 Church Street, Evanston, IL 60204) and "Adult School Crossing Guards" (available from the American Automobile Association, Falls Church, VA 22042).

Information for the organization, administration and operation of a student patrol program are given in "Policies and Practices for School Safety Patrols" (available from the American Automobile Association, Falls Church, VA 22042).

Section 7E.02 Adult Guards

Option:

Adult guards may be used to provide gaps in traffic at school crossings where an engineering study has shown that adequate gaps need to be created (see Section 7A.03), and where authorized by law.

Section 7E.03 Qualifications of Adult Guards

Support:

High standards for selection of adult guards are essential.

Guidance:

Adult guards should possess the following qualifications:

- A. Average intelligence
- B. Good physical condition, including sight, hearing, and mobility
- C. Mental alertness
- D. Neat appearance
- E. Good character

- F. Dependability
- G. Sense of responsibility for safety of students

Section 7E.04 Uniform of Adult Guards and Student Patrols

Guidance:

Adult guards should be uniformed so that road users and pedestrians can recognize them and respond to their signals. The uniforms should be distinctively different from those worn by regular police officers.

Adult guards and student patrols should wear high-visibility retroreflective material or clothing similar to that set forth in Section 6E.02.

Police officers should wear high-visibility retroreflective material over their uniform when directing nighttime operations.

Section 7E.05 Operating Procedures for Adult Guards

Guidance:

Adult guards should not direct traffic in the usual police regulatory sense. In the control of traffic, they should pick opportune times to create a safe gap. At these times, they should stand in the roadway to indicate that pedestrians are about to use or are using the crosswalk, and that all vehicular traffic must stop.

Adult crossing guards should use a STOP paddle. The STOP paddle should be the primary hand-signaling device.

Standard:

The STOP paddle shall be an octagonal shape. The background of the STOP face shall be red with at least 150 mm (6 in) series capital white letters and border. The paddle shall be at least 450 mm (18 in) in size and have the word message STOP on both sides. The paddle shall be retroreflectorized or illuminated when used during hours of darkness.

Section 7E.06 Police Officers

Option:

Police officers may be used for school crossing supervision.

Section 7E.07 Student Patrols**Option:**

Students patrols may be used to direct and control pedestrians at crossings near schools where adequate gaps in traffic occur frequently enough that gaps do not need to be created.

Student patrols may be used to direct and control pedestrians at signalized intersections where turning movements are not a significant problem, and may be used to assist adult guards in the control of pedestrians at crossing locations used by large numbers of pedestrians.

Guidance:

Student patrols should not be responsible for directing vehicular traffic. They should not function as police officers or adult guards.

Section 7E.08 Choice of Student Patrols**Guidance:**

Student patrols should be carefully selected. They should be students from the fifth grade or higher. Leadership and reliability should be determining qualities for patrol membership.

Parental approval should be obtained in writing before a student is used as a member of a student patrol.

Section 7E.09 Operating Procedures for Student Patrols**Guidance:**

Student patrols should use a flagging device to stop pedestrians behind the curb or edge of the roadway, and should allow them to cross only when there is an adequate gap in traffic.

Standard:

Flagging devices used during periods of twilight or darkness shall be retroreflective or illuminated.

Because they are not authorized to direct vehicular traffic, student patrols shall not use a STOP paddle.

CHAPTER 7F. GRADE-SEPARATED CROSSINGS

Section 7F.01 Function

Option:

Grade-separated crossings may be used to physically separate the crossing of school pedestrian traffic and vehicular flow.

Section 7F.02 Types of Grade-Separated Crossings

Option:

Grade-separated crossings may be either overpasses over the highway or underpasses under the highway.

Guidance:

The design should follow the guidelines given in the published policies of the American Association of State Highway and Transportation Officials, such as "A Policy on Geometric Design of Highways and Streets" (see Section 1A.11).

Support:

Experience has shown that overpasses are more satisfactory than underpasses for pedestrian crossings, as overpasses are easier to maintain and supervise.

Section 7F.03 Criteria for Use of Grade-Separated Crossings

Guidance:

If use of the grade separation will be less convenient to pedestrians than an at-grade crossing, barriers or supervision should be considered to assure a satisfactory level of use.



PART 8

Traffic Controls for Highway-Rail Grade Crossings

MUTCD 2000

Manual on Uniform Traffic Control Devices

m i l l e n n i u m e d i t i o n

December 2000



U.S. Department
of Transportation

**Federal Highway
Administration**

**PART 8. TRAFFIC CONTROLS FOR
HIGHWAY-RAIL GRADE CROSSINGS**

TABLE OF CONTENTS

	<u>Page</u>
CHAPTER 8A. GENERAL	Dec., 2000
Section 8A.01 Introduction	8A-1
Section 8A.02 Use of Standard Devices, Systems, and Practices	8A-4
Section 8A.03 Uniform Provisions	8A-4
Section 8A.04 Highway-Rail Grade Crossing Elimination	8A-5
Section 8A.05 Temporary Traffic Control Zones	8A-5
 CHAPTER 8B. SIGNS AND MARKINGS	 Dec., 2000
Section 8B.01 Purpose	8B-1
Section 8B.02 Highway-Rail Grade Crossing (Crossbuck) Sign (R15-1, R15-2).....	8B-1
Section 8B.03 Highway-Rail Grade Crossing Advance Warning Signs (W10 Series)	8B-3
Section 8B.04 EXEMPT Highway-Rail Grade Crossing Signs (R15-3, W10-1a).....	8B-5
Section 8B.05 Turn Restrictions During Preemption.....	8B-6
Section 8B.06 DO NOT STOP ON TRACKS Sign (R8-8).....	8B-6
Section 8B.07 STOP or YIELD Signs at Highway-Rail Grade Crossings	8B-7
Section 8B.08 TRACKS OUT OF SERVICE Sign (R8-9)	8B-7
Section 8B.09 Emergency Notification Sign (I-13 or I-13a).....	8B-8
Section 8B.10 TRAINS MAY EXCEED 130 km/h (80 MPH) Sign (W10-8, W10-8a)	8B-9
Section 8B.11 NO TRAIN HORN Sign (W10-9).....	8B-9
Section 8B.12 NO SIGNAL Sign (W10-10).....	8B-9
Section 8B.13 LOOK Sign (R15-8)	8B-9
Section 8B.14 Low Ground Clearance Highway-Rail Grade Crossing Sign (W10-5)	8B-11
Section 8B.15 Storage Space Signs (W10-11, W10-11a, W10-11b)	8B-11
Section 8B.16 Pavement Markings	8B-12
Section 8B.17 Stop Lines	8B-15
Section 8B.18 Dynamic Envelope Delineation.....	8B-15
 CHAPTER 8C. ILLUMINATION	 Dec., 2000
Section 8C.01 Illumination at Highway-Rail Grade Crossings	8C-1

CHAPTER 8D. FLASHING-LIGHT SIGNALS, GATES, AND TRAFFIC CONTROL SIGNALSDec., 2000

Section 8D.01 Introduction8D-1
 Section 8D.02 Flashing-Light Signals, Post-Mounted.....8D-3
 Section 8D.03 Flashing-Light Signals, Overhead Structures8D-4
 Section 8D.04 Automatic Gates8D-5
 Section 8D.05 Four-Quadrant Gate Systems8D-6
 Section 8D.06 Train Detection8D-9
 Section 8D.07 Traffic Control Signals at or Near Highway-Rail
 Grade Crossings8D-10

FIGURES

CHAPTER 8A. GENERAL

Figure 8A-1 Train Dynamic Envelope Delineation8A-2

CHAPTER 8B. SIGNS AND MARKINGS

Figure 8B-1 Highway-Rail Grade Crossing (Crossbuck) Sign8B-2
 Figure 8B-2 Typical Placement of Warning Signs and Pavement Markings at
 Highway-Rail Grade Crossings8B-13
 Figure 8B-3 Typical Highway-Rail Grade Crossing Pavement Markings8B-14
 Figure 8B-4 Typical Train Dynamic Envelope Delineation
 Pavement Markings8B-16

CHAPTER 8D. FLASHING LIGHT SIGNALS, GATES, AND TRAFFIC CONTROL SIGNALS

Figure 8D-1 Composite Drawing of Active Traffic Control Devices for
 Highway-Rail Grade Crossings Showing Clearances.....8D-2
 Figure 8D-2 Typical Location Plan for Flashing-Light Signals and
 Four-Quadrant Gates8D-7

CHAPTER 8A. GENERAL

Section 8A.01 Introduction

Support:

Traffic control for highway-rail grade crossings includes all signs, signals, markings, and other warning devices. It also includes their supports along highways approaching and at highway-rail grade crossings. The function of this traffic control is to permit safe and efficient operation of both rail and highway traffic at highway-rail grade crossings.

For purposes of installation, operation, and maintenance of traffic control devices at highway-rail grade crossings, it is recognized that the crossing of the highway and rail tracks is situated on a right-of-way available for the joint use of both highway traffic and railroad traffic.

The highway agency or authority with jurisdiction and the regulatory agency with statutory authority, if applicable, jointly determine the need and selection of devices at a highway-rail grade crossing.

In Part 8, the combination of devices selected or installed at a specific highway-rail grade crossing is referred to as a "traffic control system."

Standard:

The traffic control devices, systems, and practices described herein shall be used at all highway-rail grade crossings open to public travel, consistent with Federal, State, and local laws and regulations.

To ensure an understanding of common terminology between highway and railroad signaling issues, the following definitions shall be used:

- 1. Advance Preemption and Advance Preemption Time – notification of an approaching train is forwarded to the highway traffic signal controller unit or assembly by railroad equipment for a period of time prior to activating the railroad active warning devices. This period of time is the difference in the maximum preemption time required for highway traffic signal operation and the minimum warning time needed for railroad operations and is called the advance preemption time.**
- 2. Cantilevered Signal Structure – a structure that is rigidly attached to a vertical pole and is used to provide overhead support of signal units.**
- 3. Clear Storage Distance – the distance available for vehicle storage measured between 1.8 m (6 ft) from the rail nearest the intersection to the intersection stop line or the normal stopping point on the highway. At skewed highway-rail grade crossings and intersections, the 1.8 m (6 ft) distance shall be**

measured perpendicular to the nearest rail either along the centerline or edge line of the highway, as appropriate, to obtain the shorter clear distance.

4. **Design Vehicle** – the longest vehicle permitted by statute of the road authority (State or other) on that roadway.
5. **Dynamic Envelope Delineation** – the dynamic envelope is the clearance required for the train and its cargo overhang due to any combination of loading, lateral motion, or suspension failure (see Figure 8A-1).
6. **Interconnection** – the electrical connection between the railroad active warning system and the traffic signal controller assembly for the purpose of preemption.
7. **Maximum Preemption Time** – the maximum amount of time needed following initiation of the preemption sequence for the highway traffic signals to complete the timing of the right-of-way transfer time, queue clearance time, and separation time.
8. **Minimum Track Clearance Distance** – for standard two-quadrant railroad warning devices, the minimum track clearance distance is the length along a highway at one or more railroad tracks, measured either from the railroad

Figure 8A-1. Train Dynamic Envelope Delineation

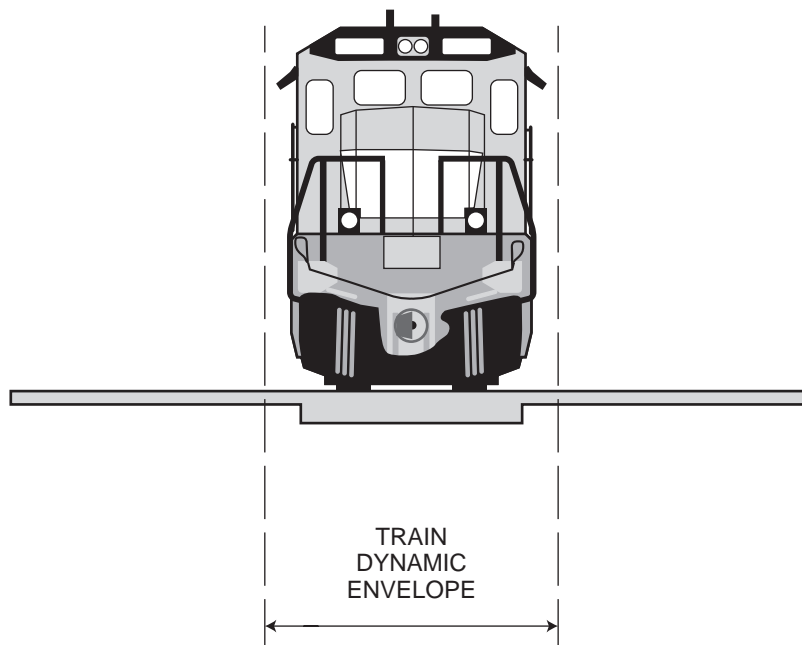

stop line, warning device, or 3.7 m (12 ft) perpendicular to the track centerline, to 1.8 m (6 ft) beyond the track(s) measured perpendicular to the far rail, along the centerline or edge line of the highway, as appropriate, to obtain the longer distance.

9. **Minimum Warning Time – Through Train Movements** – the least amount of time active warning devices shall operate prior to the arrival of a train at a highway-rail grade crossing.
10. **Monitored Interconnected Operation** – an interconnected operation that has the capability to be monitored by the railroad and/or highway authority at a location away from the highway-rail grade crossing.
11. **Preemption** – the transfer of normal operation of traffic signals to a special control mode.
12. **Pre-Signal** – supplemental highway traffic signal faces operated as part of the highway intersection traffic signals, located in a position that controls traffic approaching the railroad crossing and intersection.
13. **Queue Clearance Time** – the time required for the design vehicle stopped within the minimum track clearance distance to start up and move through the minimum track clearance distance. If pre-signals are present, this time shall be long enough to allow the vehicle to move through the intersection, or to clear the tracks if there is sufficient clear storage distance.
14. **Right-of-Way Transfer Time** – the maximum amount of time needed for the worst case condition, prior to display of the track clearance green interval. This includes any railroad or traffic signal control equipment time to react to a preemption call, and any traffic signal green, pedestrian walk and clearance, yellow change, and red clearance intervals for conflicting traffic.
15. **Separation Time** – the component of maximum preemption time during which the minimum track clearance distance is clear of vehicular traffic prior to the arrival of the train.
16. **Simultaneous Preemption** – notification of an approaching train is forwarded to the highway traffic signal controller unit or assembly and railroad active warning devices at the same time.

Section 8A.02 Use of Standard Devices, Systems, and Practices**Support:**

Because of the large number of significant variables to be considered, no single standard system of traffic control devices is universally applicable for all highway-rail grade crossings.

Guidance:

The appropriate traffic control system should be determined by an engineering study involving both the highway agency and the railroad company.

Option:

The engineering study may include the Highway-Rail Intersection (HRI) components of the National Intelligent Transportation Systems (ITS) architecture, which is a USDOT accepted method for linking the highway, vehicles, and traffic management systems with rail operations and wayside equipment.

Support:

More detail on HRI is available from USDOT's Federal Railroad Administration, 400 Seventh Street, SW, Washington, DC 20590.

Standard:

Traffic control devices, systems, and practices shall be consistent with the design and application of the standards contained herein.

Before a new or modified highway-rail grade crossing traffic control system is installed, approval shall be obtained from the highway agency with the jurisdictional and/or statutory authority, and from the railroad company.

Support:

Many other details of highway-rail grade crossing traffic control systems that are not set forth herein are contained in the references listed in Section 1A.11.

Section 8A.03 Uniform Provisions**Standard:**

All signs used in highway-rail grade crossing traffic control systems shall be retroreflectorized or illuminated as described in Section 2A.08 to show the same shape and similar color to an approaching road user during both day and night.

No sign or signal shall be located in the center of an undivided highway, except in an island with non-mountable curbs.

Guidance:

Such signs or signals should be installed at least 0.6 m (2 ft) from the face of each curb to the nearest edge of the sign or signal, except as allowed in Section 2A.19.

Where the distance between tracks, measured along the highway between the inside rails, exceeds 30 m (100 ft), additional signs or other appropriate traffic control devices should be used.

Section 8A.04 Highway-Rail Grade Crossing Elimination

Standard:

When a highway-rail grade crossing is eliminated, the traffic control devices for the crossing shall be removed.

If the existing traffic control devices at a multiple-track highway-rail grade crossing become improperly placed or inaccurate because of the removal of some of the tracks, the existing devices shall be relocated and/or modified.

Guidance:

Any highway-rail grade crossing that cannot be justified should be eliminated.

Where a roadway is removed from a highway-rail grade crossing, the roadway approaches in the railroad right-of-way should also be removed and appropriate signs placed at the roadway end in accordance with Section 3C.04.

Where a railroad is eliminated at a highway-rail grade crossing, the tracks should be removed or paved over.

Section 8A.05 Temporary Traffic Control Zones

Standard:

Traffic controls for temporary traffic control zones that include highway-rail grade crossings shall be as outlined in Part 6.

When a highway-rail grade crossing exists either within or in the vicinity of a temporary traffic control zone, lane restrictions, flagging, or other operations shall

not be performed in a manner that would cause vehicles to stop on the railroad tracks, unless a law enforcement officer or flagger is provided at the highway-rail grade crossing to minimize the possibility of vehicles stopping on the tracks, even if automatic warning devices are in place.

Guidance:

Public and private agencies, including emergency services, businesses, and railroad companies, should meet to plan appropriate traffic detours and the necessary signing, marking, and flagging requirements for operations during temporary traffic control zone activities. Consideration should be given to the length of time that the highway-rail grade crossing is to be closed, the type of rail and highway traffic affected, the time of day, and the materials and techniques of repair.

Inconvenience, delay, and crash potential to affected traffic should be minimized. Prior notice should be given to affected public or private agencies, emergency services, businesses, railroad companies, and road users before free movement of vehicles or trains is infringed upon or blocked.

Temporary traffic control zone activities should not extensively prolong the closing of the highway-rail grade crossing. The width and riding quality of the highway surface at a highway-rail grade crossing should, at a minimum, be restored to correspond with the quality of the approaches to the highway-rail grade crossing.

CHAPTER 8B. SIGNS AND MARKINGS

Section 8B.01 Purpose

Support:

Passive traffic control systems, consisting of signs and pavement markings, identify and direct attention to the location of a highway-rail grade crossing and advise drivers, bicyclists, and pedestrians to take appropriate action.

Section 8B.02 Highway-Rail Grade Crossing (Crossbuck) Sign (R15-1, R15-2)

Standard:

The Highway-Rail Grade Crossing (R15-1) sign, commonly identified as the Crossbuck sign, shall be retroreflectorized white with the words RAILROAD CROSSING in black lettering, mounted as shown in Figure 8B-1.

As a minimum, one Crossbuck sign shall be used on each highway approach to every highway-rail grade crossing, alone or in combination with other traffic control devices.

If automatic gates are not present and if there are two or more tracks at the highway-rail grade crossing, the number of tracks shall be indicated on a supplemental Number of Tracks (R15-2) sign of inverted T shape mounted below the Crossbuck sign in the manner and at the height indicated in Figure 8B-1.

Option:

The supplemental Number of Tracks sign may also be used at highway-rail grade crossings with automatic gates.

Standard:

The Crossbuck sign shall be installed on the right side of the highway on each approach to the highway-rail grade crossing. Where restricted sight distance or unfavorable highway geometry exists on an approach to a highway-rail grade crossing, an additional Crossbuck sign shall be installed on the left side of the highway, possibly placed back-to-back with the Crossbuck sign for the opposite approach, or otherwise located so that two Crossbuck signs are displayed for that approach.

A strip of retroreflective white material not less than 50 mm (2 in) in width shall be used on the back of each blade of each Crossbuck sign for the length of each

Figure 8B-1. Highway-Rail Grade Crossing (Crossbuck) Sign

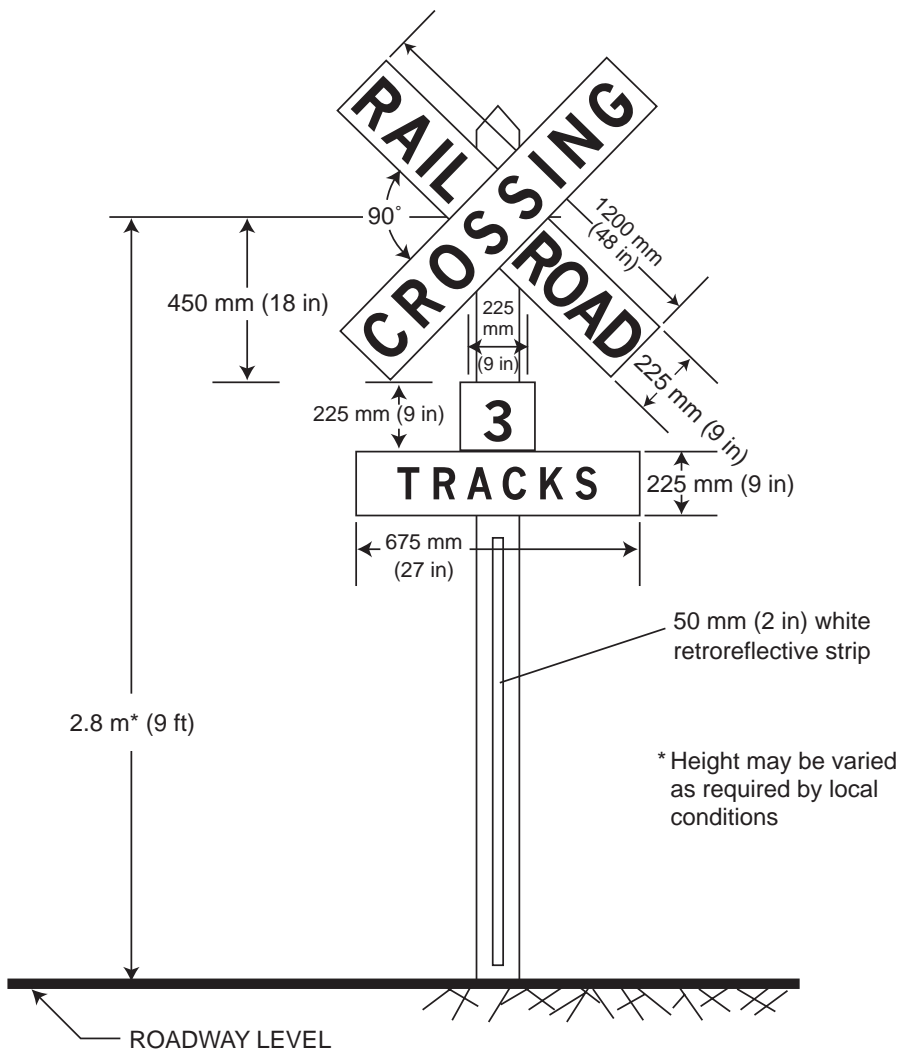
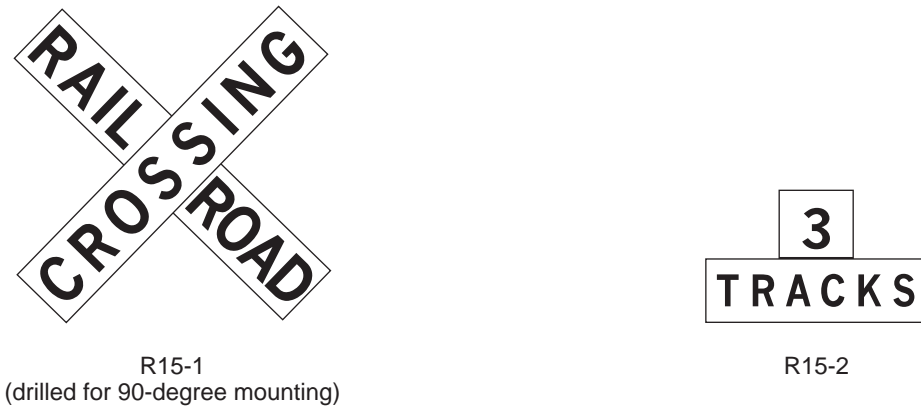

blade, at all highway-rail grade crossings, except those where Crossbuck signs have been installed back-to-back.

A strip of retroreflective white material, not less than 50 mm (2 in) in width, shall be used on each support at highway-rail grade crossings for the full length of the front and back of the support from the Crossbuck sign or Number of Tracks sign to near ground level.

Guidance:

Crossbuck signs should be located with respect to the highway pavement or shoulder in accordance with the criteria in Chapter 2A and Figures 2A-1 and 2A-2, and should be located with respect to the nearest track in accordance with Figure 8D-2.

The lateral clearance for the nearest edge of the Crossbuck sign should be 1.8 m (6 ft) from the edge of the shoulder, or 3.7 m (12 ft) from the edge of the traveled way in rural areas, and 0.6 m (2 ft) from the face of the curb in urban areas.

Where unusual conditions make variations in location and lateral clearance appropriate, engineering judgment should be used to provide the best practical combination of view and safety clearances.

Section 8B.03 Highway-Rail Grade Crossing Advance Warning Signs (W10 Series)

Standard:

A Highway-Rail Grade Crossing Advance Warning (W10-1) sign shall be used on each highway in advance of every highway-rail grade crossing except in the following circumstances:

- A. If the distance between the railroad tracks and the parallel highway, from the edge of the track to the edge of the highway, is less than 30 m (100 ft), the W10-2, W10-3, or W10-4 signs shall be used on the parallel highway to warn road users making a turn that they will encounter a highway-rail grade crossing soon after making the turn.**
- B. On low-volume, low-speed highways crossing minor spurs or other tracks that are infrequently used and are flagged by train crews.**
- C. In business districts where active highway-rail grade crossing traffic control devices are in use.**
- D. Where physical conditions do not permit even a partially effective display of the sign.**



W10-1

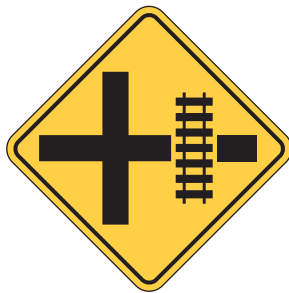

W10-2



W10-3

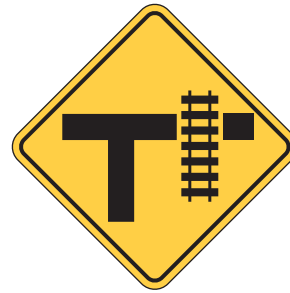

W10-4

Placement of the Highway-Rail Grade Crossing Advance Warning sign shall be in accordance with Table 2C-4 in Chapter 2C.

Option:

On divided highways and one-way streets, an additional W10-1 sign may be installed on the left side of the roadway.

Standard:

If the W10-2, W10-3, or W10-4 signs are used, sign placement shall be in accordance with Table 2C-4 in Chapter 2C (using the speed of the turning maneuver), and shall be measured from the highway intersection.

Guidance:

If the distance between the railroad tracks and the parallel highway, from the edge of the track to the edge of the roadway, is 30 m (100 ft) or more, a W10-1 sign should be installed in advance of the highway-rail grade crossing, and the W10-2, W10-3, or W10-4 signs should not be used on the parallel highway.

Section 8B.04 EXEMPT Highway-Rail Grade Crossing Signs (R15-3, W10-1a)

Option:

When authorized by law or regulation, a supplemental sign (R15-3) with a white background bearing the word EXEMPT may be used below the Crossbuck sign or Number of Tracks sign, if present, at the highway-rail grade crossing, and a supplemental sign (W10-1a) with a yellow background bearing the word EXEMPT may be used below the Highway-Rail Advance Warning sign.

Support:

These supplemental signs inform drivers of vehicles carrying passengers for hire, school buses carrying students, or vehicles carrying hazardous materials that a stop is not required at certain designated highway-rail grade crossings, except when a train, locomotive, or other railroad equipment is approaching or occupying the highway-rail grade crossing, or the driver's view is blocked.



R15-3 White background
W10-1a Yellow background

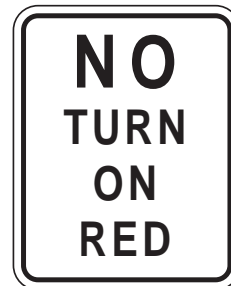

R10-11a



R8-8



R8-9

Section 8B.05 Turn Restrictions During Preemption**Guidance:**

At a signalized intersection that is located within 60 m (200 ft) of a highway-rail grade crossing, measured from the edge of the track to the edge of the roadway, where the intersection traffic control signals are preempted by the approach of a train, all existing turning movements toward the highway-rail grade crossing should be prohibited during the signal preemption sequences.

Option:

A blank-out or changeable message sign and/or appropriate traffic signal indication or other similar type sign may be used to prohibit turning movements toward the highway-rail grade crossing during preemption.

Standard:

Turn prohibition signs that are associated with preemption shall be visible only when the highway-rail grade crossing restriction is in effect.

Section 8B.06 DO NOT STOP ON TRACKS Sign (R8-8)**Guidance:**

Whenever engineering judgment determines that the potential for vehicles stopping on the tracks is high, a DO NOT STOP ON TRACKS (R8-8) should be used.

The sign, if used, should be located on the right side of the highway on the near or far side of the highway-rail grade crossing, depending upon which side provides better visibility to approaching drivers.

Option:

DO NOT STOP ON TRACKS signs may be placed on both sides of the track.

On divided highways and one-way streets, a second DO NOT STOP ON TRACKS sign may be placed on the near or far left side of the highway-rail grade crossing to further improve visibility.

Section 8B.07 STOP or YIELD Signs at Highway-Rail Grade Crossings**Option:**

At the discretion of the responsible State or local highway agency, STOP (R1-1) or YIELD (R1-2) signs may be used at highway-rail grade crossings that have two or more trains per day and are without automatic traffic control devices.

Support:

Two or more trains per day means an average of two or more trains per day operating over the highway-rail grade crossing for a 12-month period prior to the installation of the STOP or YIELD control sign.

Option:

For other highway-rail grade crossings with passive warning devices, STOP or YIELD signs may be used based on an engineering study.

Guidance:

The engineering study should take into consideration such factors as highway and train traffic characteristics (including volume and speed), collision history, the need for active control devices, and sight distance to the approaching train.

Option:

If a STOP or YIELD sign is installed at a highway-rail grade crossing, it may be installed on the Crossbuck post or on a separate post at a point where the vehicle is to stop, or as near to that point as practical.

Standard:

For all highway-rail grade crossings where STOP or YIELD signs are installed, the placement shall conform to the requirements of Chapter 2B. Stop Ahead (W3-1a) or Yield Ahead (W3-2a) Advance Warning signs shall also be installed if the criteria for their installation given in Section 2C.26 is met.

Section 8B.08 TRACKS OUT OF SERVICE Sign (R8-9)**Option:**

The TRACKS OUT OF SERVICE (R8-9) sign may be used at a highway-rail grade crossing instead of Crossbuck signs (R15-1, R15-2) when railroad tracks have been temporarily or permanently abandoned, but only until such time that the tracks are removed or paved over.

Standard:

When tracks are out of service, traffic control devices and gate arms shall be removed and the signal heads shall be removed or hooded or turned from view to clearly indicate that they are not in operation.

The R8-9 sign shall be removed when the tracks have been removed or covered or when the highway-rail grade crossing is returned to service.

Section 8B.09 Emergency Notification Sign (I-13 or I-13a)**Guidance:**

An Emergency Notification sign (I-13 or I-13a) should be posted at all highway-rail grade crossings to provide for emergency notification. The sign should have a white message on blue background.

Location and placement should be decided cooperatively by the railroad company and the public or private highway agencies based on specific site conditions. However, these signs are typically located on the railroad right-of-way.

This sign, which is for emergency notification, should convey a clear and simple message that is visible to anyone stalled or disabled on the railroad tracks, and to anyone with other emergencies.

Support:

Typical sign messages are shown in the following examples:

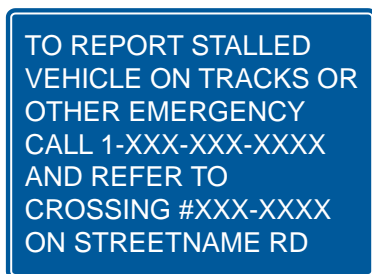

I-13



I-13a

Section 8B.10 TRAINS MAY EXCEED 130 km/h (80 MPH) Sign (W10-8, W10-8a)**Guidance:**

Where trains are permitted to travel at speeds exceeding 130 km/h (80 mph), a TRAINS MAY EXCEED 130 km/h (80 MPH) (W10-8 or W10-8a) sign should be installed facing road users approaching the highway-rail grade crossing.

If used, the TRAINS MAY EXCEED 130 km/h (80 MPH) signs should be posted between the Advance Warning (W10-1) sign and the highway-rail grade crossing on all approaches to the highway-rail grade crossing. The locations should be determined based on specific site conditions.

Section 8B.11 NO TRAIN HORN Sign (W10-9)**Standard:**

A NO TRAIN HORN (W10-9) sign shall be installed at each highway-rail grade crossing where there is a Federal Railroad Administration authorization for trains to not sound a horn. The sign shall be mounted as a supplemental plaque below the Advance Warning (W10-1) sign.

Section 8B.12 NO SIGNAL Sign (W10-10)**Option:**

A NO SIGNAL (W10-10) sign may be installed at highway-rail grade crossings that are not equipped with automated signals.

The NO SIGNAL sign may be mounted as a supplemental plaque below the Advance Warning sign.

Section 8B.13 LOOK Sign (R15-8)**Option:**

At highway-rail grade crossings that do not have active warning devices, the LOOK (R15-8) sign may be mounted as a supplemental plaque on the Crossbuck (R15-1) sign post, or as a separate sign in the immediate vicinity of the highway-rail grade crossing on the railroad right-of-way.



W10-8



W10-8a



W10-9



W10-10



R15-8



W10-5

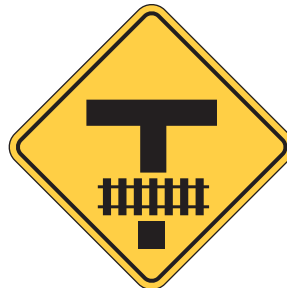

W10-11



W10-11a

OR



OR



W10-11b



Note: The W10-11 sign is a W10-3 sign modified for geometrics. Other signs can be oriented or revised as needed to satisfy the geometrics of the roadways and the railroad tracks.

Section 8B.14 Low Ground Clearance Highway-Rail Grade Crossing Sign (W10-5)**Guidance:**

If the highway profile conditions are sufficiently abrupt to create a hang-up situation for long wheelbase vehicles or for trailers with low ground clearance, the Low Ground Clearance Highway-Rail Grade Crossing (W10-5) sign should be installed in advance of the highway-rail grade crossing.

Standard:

New warning signs such as this that might not be readily recognizable by the public shall be accompanied by an educational plaque, LOW GROUND CLEARANCE which is to remain in place for at least 3 years after its initial installation (see Chapter 2A).

Guidance:

Auxiliary signs such as AHEAD, NEXT CROSSING, or USE NEXT CROSSING (with appropriate arrows) should be placed at the nearest intersecting highway where a vehicle can detour or at a point on the highway wide enough to permit a U-turn.

If engineering judgment of roadway geometric and operating conditions confirms that vehicle speeds across the railroad tracks should be below the posted speed limit, a W13-1 advisory speed plaque should be posted.

Option:

If the highway-rail grade crossing is rough, word message signs such as BUMP, DIP, or ROUGH CROSSING may be installed. A W13-1 advisory speed plaque may be installed below the word message sign in advance of rough crossings.

Support:

Information on railroad ground clearance requirements is also available in the "American Railway Engineering and Maintenance-of-Way Association's Manual," or the American Association of State Highway and Transportation Officials' "Policy on Geometric Design of Highways and Streets" (see Section 1A.11).

Section 8B.15 Storage Space Signs (W10-11, W10-11a, W10-11b)**Guidance:**

A Storage Space (W10-11) sign supplemented by a word message storage distance (W10-11a) sign should be used where there is a highway intersection in close proximity

to the highway-rail grade crossing and an engineering study determines that adequate space is not available to store a design vehicle(s) between the highway intersection and the train dynamic envelope.

The Storage Space (W10-11 and W10-11a) signs should be mounted in advance of the highway-rail grade crossing at an appropriate location to advise drivers of the space available for vehicle storage between the highway intersection and the highway-rail grade crossing.

Option:

The Storage Space sign, W10-11b, may be mounted beyond the highway-rail grade crossing at the highway intersection under the STOP or YIELD sign or just prior to the signalized intersection to remind drivers of the storage space between the tracks and the highway intersection.

Section 8B.16 Pavement Markings

Standard:

All highway-rail grade crossing markings shall be retroreflectorized white. All other markings shall be in accordance with Part 3.

Pavement markings in advance of a highway-rail grade crossing shall consist of an X, the letters RR, a no-passing marking (two-lane highways), and certain transverse lines as shown in Figures 8B-2 and 8B-3.

Identical markings shall be placed in each approach lane on all paved approaches to highway-rail grade crossings where signals or automatic gates are located, and at all other highway-rail grade crossings where the posted or statutory highway speed is 60 km/h (40 mph) or greater.

Pavement markings shall not be required at highway-rail grade crossings where the posted or statutory highway speed is less than 60 km/h (40 mph), or in urban areas, if an engineering study indicates that other installed devices provide suitable warning and control.

Guidance:

When pavement markings are used, a portion of the X symbol should be directly opposite the Advance Warning sign. The X symbol and letters should be elongated to allow for the low angle at which they will be viewed.

Figure 8B-2. Typical Placement of Warning Signs and Pavement Markings at Highway-Rail Grade Crossings

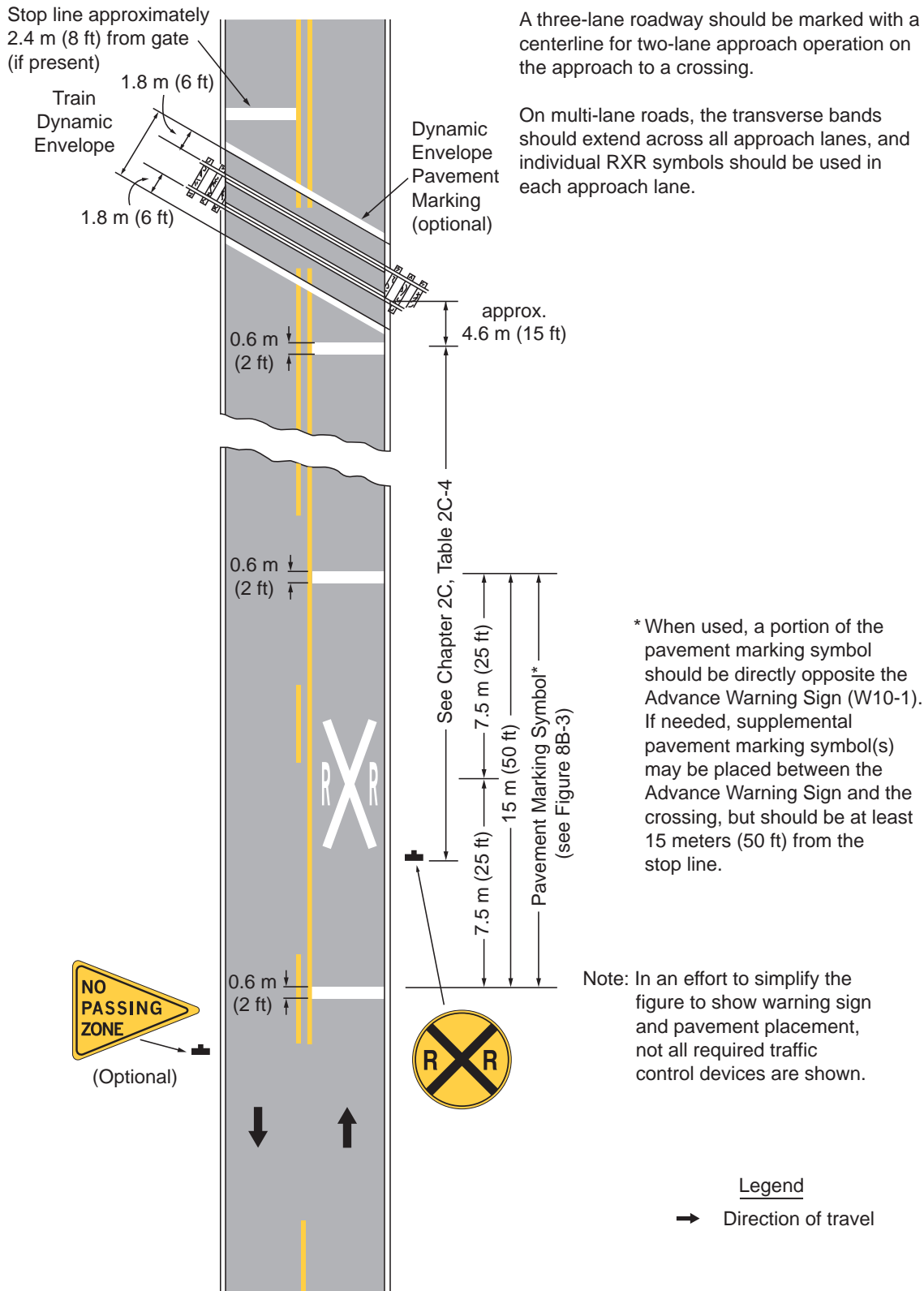
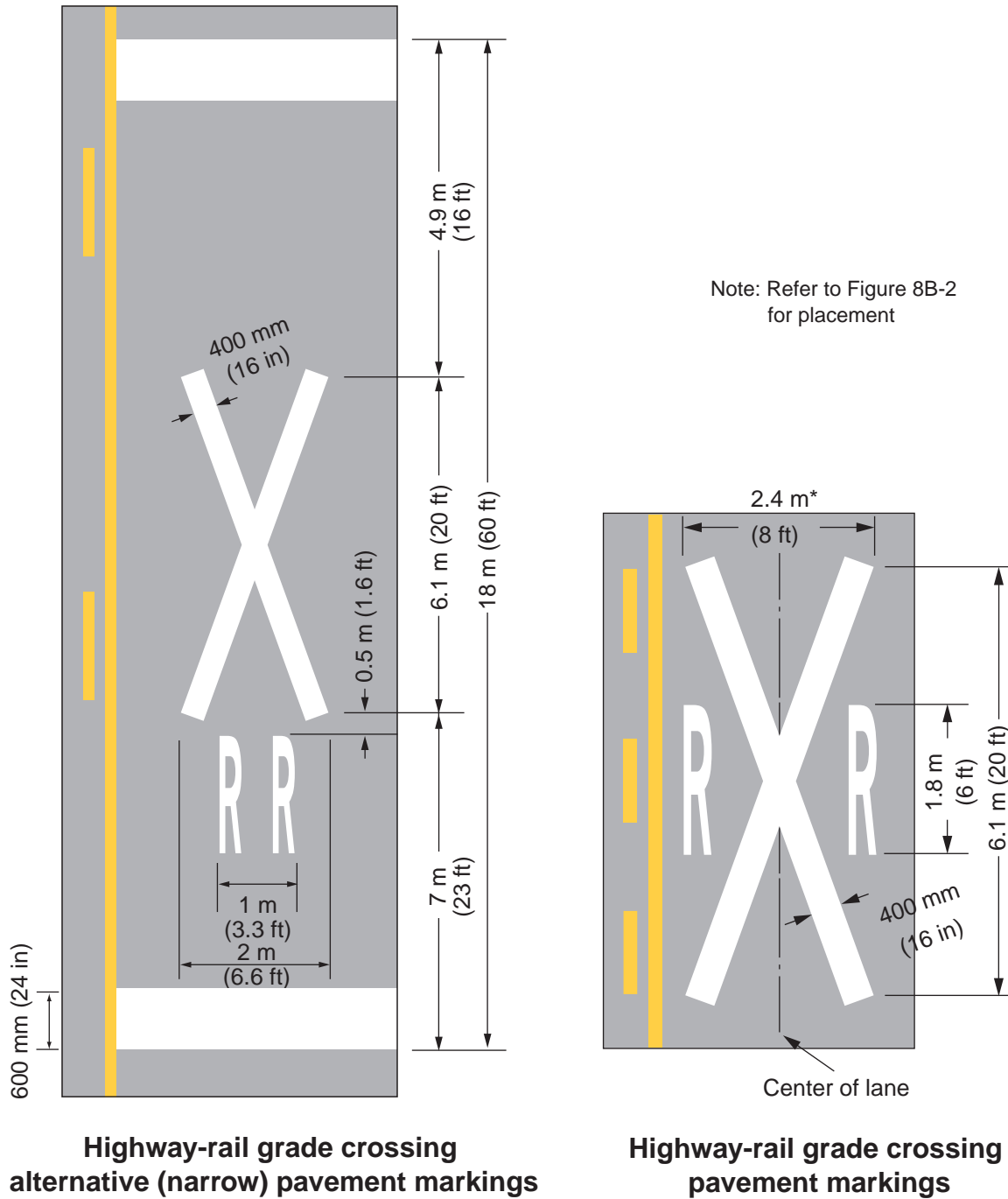

Figure 8B-3. Typical Highway-Rail Grade Crossing Pavement Markings



*Width may vary according to lane width

Option:

When justified by engineering judgment, supplemental pavement marking symbol(s) may be placed between the Advance Warning sign and the highway-rail grade crossing.

Section 8B.17 Stop Lines

Guidance:

The stop line should be a transverse line at a right angle to the traveled way at a point where a vehicle is to stop or as near to that point as possible. The stop line should be placed approximately 2.4 m (8 ft) from the gate (if present), but no closer than 4.6 m (15 ft) from the nearest rail.

Section 8B.18 Dynamic Envelope Delineation

Option:

Dynamic envelope markings may be used to mark the edges of the dynamic envelope where there is a highway intersection in close proximity to the highway-rail grade crossing and an engineering study determines that vehicles might stop within the dynamic envelope area.

Standard:

If used, pavement markings for indicating the dynamic envelope shall conform to Part 3 and shall be a 100 mm (4 in) normal solid white line or contrasting pavement color and/or contrasting pavement texture.

Guidance:

If used, dynamic envelope pavement markings should be placed on the highway 1.8 m (6 ft) from the nearest rail, installed parallel to the tracks, unless the operating railroad company advises otherwise. The pavement markings should extend across the roadway as shown in Figure 8B-4.

Figure 8B-4. Typical Train Dynamic Envelope Delineation Pavement Markings

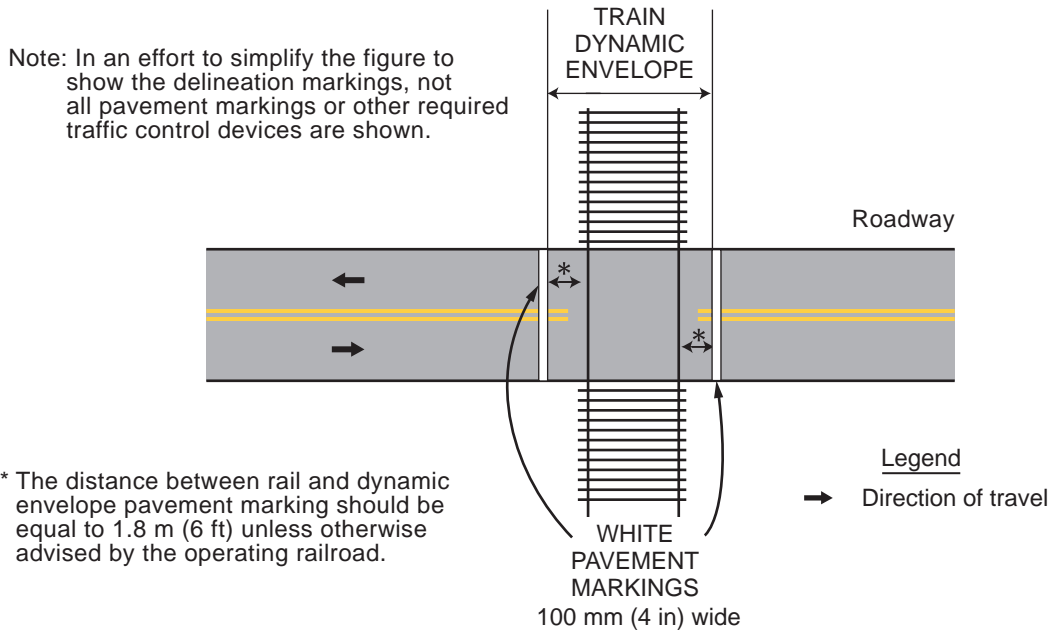

CHAPTER 8C. ILLUMINATION

Section 8C.01 Illumination at Highway-Rail Grade Crossings

Option:

When an engineering study determines that better nighttime visibility of the train and the highway-rail grade crossing is needed (for example, where a substantial amount of railroad operation is conducted at night, where train speeds are low and highway-rail grade crossings are blocked for long periods, or crash history indicates that drivers experience difficulty in seeing trains or traffic control devices during hours of darkness) illumination at and adjacent to the highway-rail grade crossing may be installed.

Support:

Types and location of luminaires for highway-rail grade crossing illumination are contained in the American National Standards Institute's (ANSI) "Practice for Roadway Lighting RP8" available from the Illuminating Engineering Society (see Section 1A.11).

CHAPTER 8D. FLASHING-LIGHT SIGNALS, GATES, AND TRAFFIC CONTROL SIGNALS

Section 8D.01 Introduction

Support:

Active traffic control systems inform drivers, bicyclists, and pedestrians of the approach or presence of trains, locomotives, or other railroad equipment at highway-rail grade crossings.

A composite drawing (see Figure 8D-1) shows a post-mounted flashing-light signal (two light units mounted in a horizontal line), a flashing-light signal mounted on an overhead structure, and an automatic gate assembly.

Option:

These systems may be used separately or in combination with each other as determined by an engineering study.

Standard:

The meaning of flashing-light signals and gates shall be as stated in the "Uniform Vehicle Code" (see Sections 11-701 and 11-703 of the "UVC"), which is available from the National Committee on Uniform Traffic Laws and Ordinances (see Page i for the address).

Location and clearance dimensions for flashing-light signals and gates shall be as shown in Figure 8D-1.

When there is a curb, a horizontal clearance of at least 0.6 m (2 ft) shall be provided from the face of the vertical curb to the closest part of the signal or gate arm in its upright position. When a cantilevered-arm flashing-light signal is used, the vertical clearance shall be at least 5.2 m (17 ft) above the crown of the highway to the lowest point of the signal unit.

Where there is a shoulder, but no curb, a horizontal clearance of at least 0.6 m (2 ft) from the edge of a paved or surfaced shoulder shall be provided, with a clearance of at least 1.8 m (6 ft) from the edge of the traveled way.

Where there is no curb or shoulder, the minimum horizontal clearance shall be 1.8 meters (6 feet) from the edge of the traveled way.

Guidance:

Equipment housings (controller cabinets) should have a lateral clearance of at least 9 m (30 ft) from the edge of the highway, and where railroad property and conditions

Figure 8D-1. Composite Drawing of Active Traffic Control Devices for Highway-Rail Grade Crossings Showing Clearances

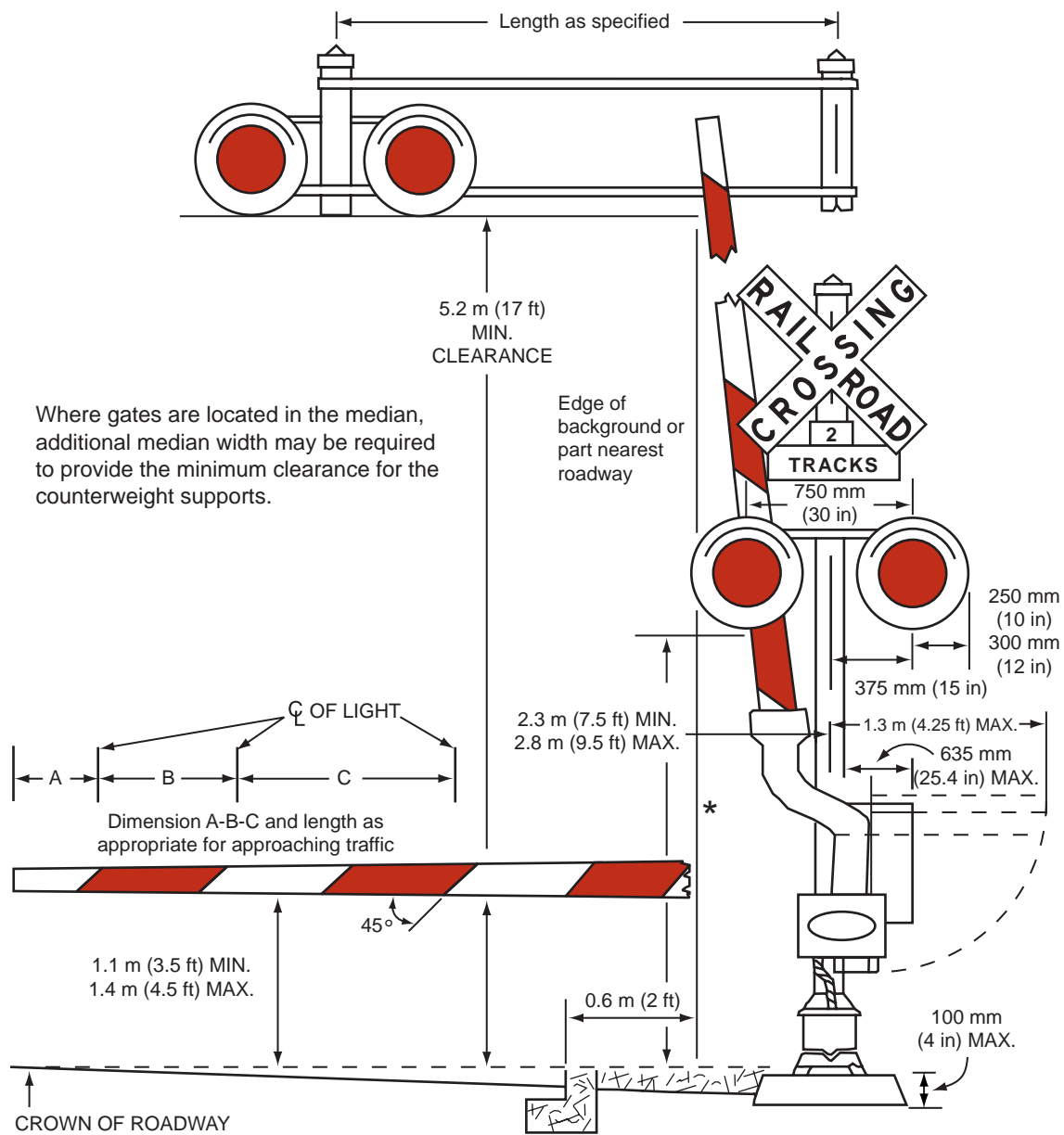

*For locating this reference line at other than curb section installation, see Section 8B.02.

allow, at least 7.6 m (25 ft) from the nearest rail.

If a pedestrian route is provided, sufficient clearance from supports, posts, and gate mechanisms should be maintained for pedestrian travel.

When determined by an engineering study, a lateral escape route to the right of the highway in advance of the highway-rail grade crossing traffic control devices should be kept free of guardrail or other ground obstructions. Where guardrail is not deemed necessary nor appropriate, barriers should not be used for protecting signal supports.

The same lateral clearance and roadside safety features should apply to flashing-light signal and automatic gate locations on both the right and left sides of the roadway.

Option:

In industrial or other areas involving only low-speed highway traffic or where signals are vulnerable to damage by turning truck traffic, guardrail may be installed to provide protection for the signal assembly.

Section 8D.02 Flashing-Light Signals, Post-Mounted

Standard:

The flashing-light signal assembly (shown in Figure 8D-1) on the side of the highway shall include a standard Crossbuck (R15-1) sign, and where there is more than one track, a supplemental Number of Tracks (R15-2) sign, all of which indicate to drivers, bicyclists, and pedestrians the location of a highway-rail grade crossing.

Option:

Bells or other audible warning devices may be included in the assembly and may be operated in conjunction with the flashing lights to provide additional warning for pedestrians and bicyclists.

Standard:

When indicating the approach or presence of a train, the flashing-light signal shall display toward approaching highway traffic two red lights mounted in a horizontal line flashing alternately.

Flashing-light signals shall be placed to the right of approaching highway traffic on all highway approaches to a highway-rail grade crossing. They shall be located laterally with respect to the highway in conformance with Figure 8D-2 except where such location would adversely affect signal visibility.

At highway-rail grade crossings with highway traffic in both directions, back-to-back pairs of lights shall be placed on each side of the tracks. On multi-lane one-way streets and divided highways, flashing light signals shall be placed on the approach side of the highway-rail grade crossing on both sides of the roadway or shall be placed above the highway.

Each red signal unit in the flashing-light signal shall flash alternately. The number of flashes per minute for each lamp shall be 35 minimum and 65 maximum. Each lamp shall be illuminated approximately the same length of time. Total time of illumination of each pair of lamps shall be the entire operating time. Flashing-light units shall use either 200 mm (8 in) or 300 mm (12 in) nominal diameter lenses.

Guidance:

In choosing between the two sizes of lenses for use in highway-rail grade crossing traffic control signals, consideration should be given to the principles stated in Chapter 4D.

Standard:

Highway-rail grade crossing flashing-light signals shall operate at a low voltage using storage batteries either as a primary or stand-by source of electrical energy. Provision shall be made to provide a source of energy for charging batteries.

Option:

Additional pairs of flashing-light units may be mounted on the same supporting post and directed toward vehicular traffic approaching the highway-rail grade crossing from other than the principal highway route, such as where there are approaching routes on highways closely adjacent to and parallel to the railroad.

Section 8D.03 Flashing-Light Signals, Overhead Structures

Option:

Flashing-light signals may be installed on overhead structures or cantilevered supports as shown in Figure 8D-1 where needed for additional emphasis, or for better visibility to approaching traffic, particularly on multi-lane approaches or highways with profile restrictions.

If it is determined by an engineering study that one set of flashing lights on the cantilever arm is not sufficiently visible to road users, one or more additional sets of flashing lights may be mounted on the supporting post and/or on the cantilever arm.

Standard:

Breakaway or frangible bases shall not be used for overhead structures or cantilevered supports.

Section 8D.04 Automatic Gates**Support:**

An automatic gate is a traffic control device used as an adjunct to flashing-light signals.

Standard:

The automatic gate (see Figure 8D-1) shall consist of a drive mechanism and a fully retroreflectorized red- and white-striped gate arm with lights. When in the down position, the gate arm shall extend across the approaching lanes of highway traffic.

In the normal sequence of operation, the flashing-light signals and the lights on the gate arm (in its normal upright position) shall be activated immediately upon detection of the approaching train. The gate arm shall start its downward motion not less than 3 seconds after the flashing-light signals start to operate, shall reach its horizontal position at least 5 seconds before the arrival of the train, and shall remain in the down position as long as the train occupies the highway-rail grade crossing.

When the train clears the highway-rail grade crossing, and if no other train is detected, the gate arm shall ascend to its upright position, following which the flashing lights and the lights on the gate arm shall cease operation.

Gate arms shall be fully retroreflectorized on both sides, have 45-degree diagonal stripes alternately red and white at 400 mm (16 in) intervals measured horizontally, and shall have at least three red lights as indicated in Figure 8D-1.

When activated, the gate arm light nearest the tip shall be illuminated continuously and the other lights shall flash alternately in unison with the flashing-light signals.

The approach lane gate arm mechanism shall be designed to fail safe in the down position.

Guidance:

The gate arm should ascend to its upright position in not more than 12 seconds.

In its normal upright position, when no train is approaching or occupying the highway-rail grade crossing, the gate arm should be either vertical or nearly so (see Figure 8D-1).

In the design of individual installations, consideration should be given to timing the operation of the gate arm to accommodate large and/or slow-moving vehicles.

The gates should cover the approaching highway to block all motor vehicles from being driven around the gate without crossing the centerline.

Option:

Automatic gate installations may include median islands between opposing lanes on an approach to a highway-rail grade crossing.

Where gates are located in the median, additional median width may be required to provide the minimum clearance for the counterweight supports.

Section 8D.05 Four-Quadrant Gate Systems**Option:**

Four-Quadrant Gate systems may be installed to improve safety at highway-rail grade crossings based on an engineering study when less restrictive measures, such as automatic gates and median islands, are not effective.

Standard:

A Four-Quadrant Gate system shall consist of a series of automatic gates used as an adjunct to flashing-light signals to control traffic on all lanes at the highway-rail grade crossing.

The Four-Quadrant Gate system shall consist of a drive mechanism and fully retroreflectorized red- and white-striped gate arms with lights, and when in the down position the gate arms extend individually across the approaching and exit lanes of highway traffic as shown in Figure 8D-2. Standards contained in Sections 8D.01 through 8D.03 for flashing-light signals shall be followed for signal specifications, location, and clearance distances.

In the normal sequence of operation, the flashing-light signals and the lights on the gate arms (in their normal upright positions) shall be activated immediately

upon detection of the approaching train. The gate arms for the approaching lanes of traffic shall start their downward motion not less than 3 seconds after the flashing-light signals start to operate and shall reach its horizontal position at least 5 seconds before the arrival of the train. Exit lane gate arm activation and downward motion shall be based on detection or timing requirements established by an engineering study of the individual site. The gate arms shall remain in the down position as long as the train occupies the highway-rail grade crossing.

When the train clears the highway-rail grade crossing, and if no other train is detected, the gate arms shall ascend to their upright positions, following which the flashing lights and the lights on the gate arms shall cease operation.

Gate arm design, colors, and lighting requirements shall be in accordance with the Standards contained in Section 8D.04.

Except as noted in the Option below, the exit lane gate arm mechanism shall be designed to fail-safe in the up position.

At locations where gate arms are offset a sufficient distance for vehicles to drive between the entrance and exit gate arms, median islands shall be installed in accordance with the needs established by an engineering study.

Guidance:

The gate arms should ascend to their upright position in not more than 12 seconds.

Four-Quadrant Gate systems should only be used in locations with constant-warning-time train detection.

Where an engineering study determines the need, vehicle intrusion detection devices should be installed at the highway-rail grade crossing.

At locations where sufficient space is available, exit gates should be set back from the track a distance that provides a safe zone long enough to accommodate at least one design vehicle between the exit gate and the nearest rail.

Four-Quadrant Gate systems should include remote health (status) monitoring capable of automatically notifying railroad signal maintenance personnel when anomalies have occurred within the system.

Option:

Exit lane gate arms may fail in the down position if the highway-rail grade crossing is equipped with remote health (status) monitoring.

Four-Quadrant Gate installations may include median islands between opposing lanes on an approach to a highway-rail grade crossing.

Guidance:

Where sufficient space is available, median islands should be at least 18 m (60 ft) in length.

Section 8D.06 Train Detection

Standard:

The devices employed in active traffic control systems shall be actuated by some form of train detection.

Train detection circuits, insofar as practical, shall be designed on the fail-safe principle.

Flashing-light signals shall operate for at least 20 seconds before the arrival of any train, except as noted in the Option below.

Option:

On tracks where all trains operate at less than 30 km/h (20 mph) and where flagging is performed by an employee on the ground, a shorter signal operating time for the flashing-light signals may be used.

Additional warning time may be provided when determined by an engineering study.

Guidance:

Where the speeds of different trains on a given track vary considerably under normal operation, special devices or circuits should be installed to provide reasonably uniform notice in advance of all train movements over the highway-rail grade crossing. Special control features should be used to eliminate the effects of station stops and switching operations within approach control circuits to prevent excessive activation of the traffic control devices while trains are stopped on or switching upon the approach track control circuits.

Section 8D.07 Traffic Control Signals at or Near Highway-Rail Grade Crossings**Option:**

Traffic control signals may be used in lieu of flashing-light signals to control road users at industrial highway-rail grade crossings and other places where train movements are very slow, such as in switching operations.

Standard:

The appropriate provisions of Part 4 relating to traffic control signal design, installation, and operation shall be applicable where traffic control signals are used to control road users in lieu of flashing-light signals at highway-rail grade crossings.

Traffic control signals shall not be used in lieu of flashing-light signals to control road users at a mainline highway-rail grade crossing.

Guidance:

The highway agency with jurisdiction, the regulatory agency with statutory authority, if applicable, and the railroad company should jointly determine the preemption operation at highway-rail grade crossings adjacent to signalized highway intersections.

When a highway-rail grade crossing is equipped with a flashing-light signal system and is located within 60 m (200 ft) of an intersection or mid-block location controlled by a traffic control signal, the traffic control signal should be provided with preemption in accordance with Section 4D.13.

Coordination with the flashing-light signal system should be considered for traffic control signals located farther than 60 m (200 ft) from the highway-rail grade crossing. Factors to be considered should include traffic volumes, vehicle mix, vehicle and train approach speeds, frequency of trains, and queue lengths.

Standard:

If preemption is provided, the normal sequence of traffic control signal indications shall be preempted upon the approach of trains to avoid entrapment of vehicles on the highway-rail grade crossing by conflicting aspects of the traffic control signals and the highway-rail grade crossing flashing-light signals.

This preemption feature shall have an electrical circuit of the closed-circuit principle, or a supervised communication circuit between the control circuits of the highway-rail grade crossing warning system and the traffic control signal controller. The traffic control signal controller preemptor shall be activated via the supervised communication circuit or the electrical circuit that is normally energized

by the control circuits of the highway-rail grade crossing warning system. The approach of a train to a highway-rail grade crossing shall de-energize the electrical circuit or activate the supervised communication circuit, which in turn shall activate the traffic control signal controller preemptor. This shall establish and maintain the preemption condition during the time the highway-rail grade crossing warning system is activated, except that when crossing gates exist, the preemption condition shall be maintained until the crossing gates are energized to start their upward movement. When multiple or successive preemptions occur, train activation shall receive first priority.

If a pre-signal is installed at an interconnected highway-rail grade crossing near a signalized intersection, a STOP HERE ON RED (R10-6) sign shall be installed near the pre-signal or at the stop line if used. If there is a nearby signalized intersection with insufficient clear storage distance for a design vehicle, or the highway-rail grade crossing does not have gates, a NO TURN ON RED (R10-11) sign shall be installed for the approach that crosses the railroad track.

Option:

Where highway traffic signals must be located within close proximity to the flashing-light signal system, the highway traffic signals may be mounted on the same overhead structure as the flashing-light signals.

Support:

Section 4D.13 describes additional considerations regarding preemption of traffic control signals at or near highway-rail grade crossings.

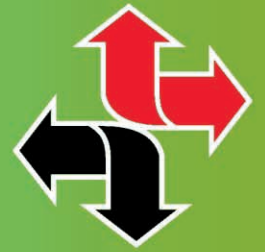

PART 9

Traffic Controls for Bicycle Facilities

MUTCD 2000

Manual on Uniform Traffic Control Devices

m i l l e n n i u m e d i t i o n

December 2000



U.S. Department
of Transportation

**Federal Highway
Administration**

PART 9. TRAFFIC CONTROLS FOR BICYCLE FACILITIES**TABLE OF CONTENTS**

	<u>Page</u>
CHAPTER 9A. GENERALDec., 2000
Section 9A.01 Requirements for Bicyclist Traffic Control Devices.....	9A-1
Section 9A.02 Scope	9A-1
Section 9A.03 Definitions Relating to Bicycles	9A-1
Section 9A.04 Maintenance	9A-2
Section 9A.05 Relation to Other Documents.....	9A-2
Section 9A.06 Placement Authority	9A-3
Section 9A.07 Meaning of Standard, Guidance, Option, and Support.....	9A-3
Section 9A.08 Colors	9A-3
CHAPTER 9B. SIGNSDec., 2000
Section 9B.01 Application and Placement of Signs	9B-1
Section 9B.02 Design of Bicycle Signs	9B-2
Section 9B.03 STOP and YIELD Signs (R1-1, R1-2)	9B-4
Section 9B.04 Bicycle Lane Signs (R3-16, R3-17)	9B-4
Section 9B.05 BEGIN RIGHT TURN LANE YIELD TO BIKES Sign (R4-4)	9B-6
Section 9B.06 NO MOTOR VEHICLES Sign (R5-3).....	9B-6
Section 9B.07 Bicycle Prohibition Sign (R5-6).....	9B-6
Section 9B.08 No Parking Bicycle Lane Signs (R7-9, R7-9a).....	9B-7
Section 9B.09 Bicycle Regulatory Signs (R9-5, R9-6)	9B-7
Section 9B.10 Shared-Use Path Restriction Sign (R9-7).....	9B-7
Section 9B.11 Other Regulatory Signs	9B-7
Section 9B.12 Turn or Curve Warning Signs (W1 Series)	9B-8
Section 9B.13 Intersection Warning Signs (W2 Series)	9B-8
Section 9B.14 Bicycle Surface Condition Warning Sign (W8-10).....	9B-8
Section 9B.15 Bicycle Crossing Warning Sign (W11-1)	9B-11
Section 9B.16 Other Bicycle Warning Signs	9B-11
Section 9B.17 Bicycle Route Guide Signs (D11-1).....	9B-12
Section 9B.18 Bicycle Route Markers (M1-8, M1-9)	9B-12
Section 9B.19 Destination Arrow and Supplemental Plaque Signs for Bicycle Route Signs.....	9B-16
Section 9B.20 Bicycle Parking Area Sign (D4-3)	9B-17
CHAPTER 9C. MARKINGSDec., 2000
Section 9C.01 Functions of Markings.....	9C-1
Section 9C.02 General Principles.....	9C-1
Section 9C.03 Marking Patterns and Colors on Shared-Use Paths	9C-3
Section 9C.04 Markings for Bicycle Lanes	9C-3
Section 9C.05 Word Messages and Symbols Applied to the Pavement	9C-5

Section 9C.06 Object Markers on Shared-Use Paths.....9C-5
 Section 9C.07 Pavement Markings for Obstructions.....9C-10

CHAPTER 9D. SIGNALSDec., 2000

Section 9D.01 Application9D-1
 Section 9D.02 Signal Operations for Bicycles.....9D-1

FIGURES

CHAPTER 9B. SIGNS

Figure 9B-1 Sign Placement on Shared-Use Paths.....9B-2
 Figure 9B-2 Typical Signing for the Beginning and End of a
 Bicycle Route9B-14
 Figure 9B-3 Typical Signs and Markings for Shared-Use Paths.....9B-15

CHAPTER 9C. MARKINGS

Figure 9C-1 Typical Intersection Pavement Markings - Designated Bicycle
 Lane with Left-Turn Area, Heavy Turn Volumes, Parking,
 One-Way Traffic, or Divided Highway9C-2
 Figure 9C-2 Centerline Markings for Shared-Use Paths9C-4
 Figure 9C-3 Typical Bicycle Lane Treatment at a Right Turn Only Lane9C-6
 Figure 9C-4 Typical Bicycle Lane Treatment at Parking Lane Into a Right
 Turn Only Lane9C-7
 Figure 9C-5 Typical Pavement Markings for Bicycle Lanes on a
 Two-Way Street9C-8
 Figure 9C-6 Typical Optional Word and Symbol Pavement Markings for
 Bicycle Lanes9C-9
 Figure 9C-7 Typical Obstruction Pavement Marking.....9C-10

TABLES

CHAPTER 9B. SIGNS

Table 9B-1 Sign Sizes for Shared-Use Paths9B-3

CHAPTER 9A. GENERAL

Section 9A.01 Requirements for Bicyclist Traffic Control Devices

Support:

General information and definitions concerning traffic control devices are found in Part 1.

Section 9A.02 Scope

Support:

Part 9 covers signs, pavement markings, and traffic signals specifically related to bicycle operation on both roadways and shared-use paths.

Guidance:

Parts 1, 2, 3, and 4 should be reviewed for general provisions, signs, pavement markings, and signals.

Standard:

None of the bikeway designations in this Manual shall be construed to preclude permitted bicycle travel on roadways or portions of roadways that do not have bikeway designations.

Section 9A.03 Definitions Relating to Bicycles

Standard:

The following terms shall be defined as follows when used in Part 9:

- 1. Bicycle Lane - a portion of a roadway that has been designated by signs and pavement markings for preferential or exclusive use by bicyclists.**
- 2. Bicycle Path - see Shared-Use Path.**
- 3. Bikeway - a generic term for any road, street, path, or way that in some manner is specifically designated for bicycle travel, regardless of whether such facilities are designated for the exclusive use of bicycles or are to be shared with other transportation modes.**
- 4. Designated Bicycle Route - a system of bikeways designated by the jurisdiction having authority with appropriate directional and informational**

route markers, with or without specific bicycle route numbers. Bicycle routes, which might be a combination of various types of bikeways, should establish a continuous routing.

- 5. Shared-Use Path - a bikeway physically separated from motorized vehicular traffic by an open space or barrier and either within the highway right-of-way or within an independent alignment. Shared-use paths might also be used by pedestrians, skaters, wheelchair users, joggers, and other non-motorized users.**

Section 9A.04 Maintenance

Guidance:

All signs, signals, and markings, including those on bicycle facilities, should be properly maintained to command respect from both the driver and the bicyclist. When installing signs and markings on bicycle facilities, an agency should be designated to maintain these devices.

Section 9A.05 Relation to Other Documents

Support:

"The Uniform Vehicle Code and Model Traffic Ordinance" published by the National Committee on Uniform Traffic Laws and Ordinances (see Section 1A.11) has provisions for bicycles and is the basis for the traffic control devices included herein.

Informational documents used during the development of the signing and marking recommendations in Part 9 include the following:

- A. "Guide for Development of Bicycle Facilities," which is available from the American Association of State Highway and Transportation Officials (see Page i for the address).
- B. State and local government design guides.
- C. "Selecting Roadway Design Treatments to Accommodate Bicycles," FHWA Publication No. FHWA-RD-92-073, which is available from the FHWA Research and Technology Report Center, 9701 Philadelphia Court, Unit Q, Lanham, MD 20106.

Other documents that relate to the application of traffic control devices in general are listed in Section 1A.11.

Section 9A.06 Placement Authority

Support:

Section 1A.08 contains information regarding placement authority for traffic control devices.

Section 9A.07 Meaning of Standard, Guidance, Option, and Support

Support:

The introduction to this Manual contains information regarding the meaning of the headings Standard, Guidance, Option, and Support, and the use of the words shall, should, and may.

Section 9A.08 Colors

Support:

Section 1A.12 contains information regarding the color codes.

CHAPTER 9B. SIGNS

Section 9B.01 Application and Placement of Signs

Standard:

Bicycle signs shall be standard in shape, legend, and color.

All signs shall be retroreflectORIZED for use on bikeways, including shared-use paths and bicycle lane facilities.

Where signs serve both bicyclists and other road users, vertical mounting height and lateral placement shall be as specified in Part 2.

On shared-use paths, lateral sign clearance shall be a minimum of 0.9 m (3 ft) and a maximum of 1.8 m (6 ft) from the near edge of the sign to the near edge of the path.

Mounting height for ground-mounted signs on shared-use paths shall be a minimum of 1.2 m (4 ft) and a maximum of 1.5 m (5 ft), measured from the bottom edge of the sign to the near edge of the path surface.

When overhead signs are used on shared-use paths, the clearance from the bottom edge of the sign to the path surface directly under the sign shall be a minimum of 2.4 m (8 ft).

Guidance:

Signs for the exclusive use of bicyclists should be located so that drivers are not confused by them.

The clearance for overhead signs on shared-use paths should be adjusted when appropriate to accommodate typical maintenance vehicles.

Support:

Figure 9B-1 illustrates typical sign placement, lateral clearance, and mounting height for shared-use paths.

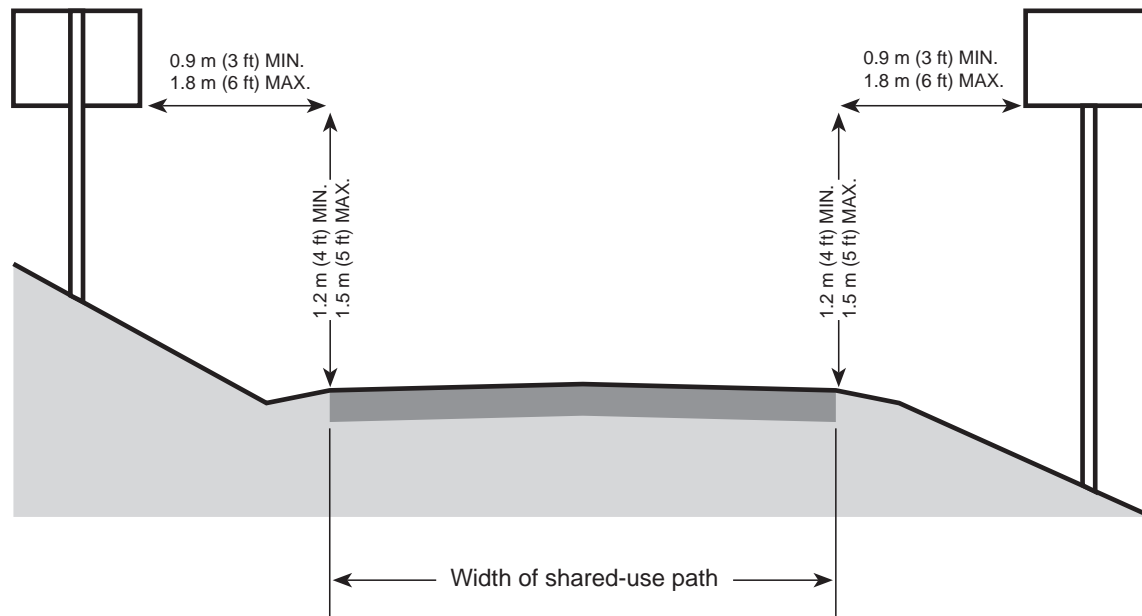
Figure 9B-1. Sign Placement on Shared-Use Paths

Section 9B.02 Design of Bicycle Signs

Standard:

If the sign applies to drivers and bicyclists, then the size shall be as shown for conventional roads in Table 2B-1.

The sign sizes for shared-use paths shall be those shown in Table 9B-1, and shall be used only for signs installed specifically for bicycle traffic applications. The sign sizes for shared-use paths shall not be used for signs that are placed in a location that would have any application to other vehicles.

Option:

Larger size signs may be used on shared-use paths when appropriate.

Guidance:

Except for size, the design of signs for bicycle facilities should be identical to that specified in this Manual for motor vehicle travel.

Support:

Uniformity in design includes shape, color, symbols, wording, lettering, and illumination or retroreflectorization.

Table 9B-1. Sign Sizes for Shared-Use Paths

Sign	MUTCD Code	Minimum Sign Size	
		Millimeters	Inches
Stop	R1-1	450 x 450	18 x 18
Yield	R1-2	600 x 600 x 600	24 x 24 x 24
Bicycle Lane	R3-16,16a,17,17a	600 x 750	24 x 30
Movement Restriction	R4-1,2,3,7	300 x 450	12 x 18
Begin Right Turn Lane Yield to Bikes	R4-4	900 x 750	36 x 30
No Motor Vehicles	R5-3	600 x 600	24 x 24
Bicycle Prohibition	R5-6	600 x 600	24 x 24
No Parking Bike Lane	R7-9,9a	300 x 450	12 x 18
Pedestrians Prohibited	R9-3a	450 x 450	18 x 18
Bicycle Regulatory	R9-5,6	300 x 450	12 x 18
Shared-Use Path Restriction	R9-7	300 x 450	12 x 18
Railroad Crossbuck	R15-1	600 x 112	24 x 4.5
Turn and Curve Warning	W1-1,2,3,4,5	450 x 450	18 x 18
Arrow Warning	W1-6,7	600 x 300	24 x 12
Intersection Warning	W2-1,2,3,4,5	450 x 450	18 x 18
Stop, Yield, Signal Ahead	W3-1a,2a,3	450 x 450	18 x 18
Road Narrows	W5-2a	450 x 450	18 x 18
Bikeway Narrows	W5-4	450 x 450	18 x 18
Hill Sign	W7-5	450 x 450	18 x 18
Bump or Dip	W8-1,2	450 x 450	18 x 18
Bicycle Surface Condition	W8-10	450 x 450	18 x 18
Advance Grade Crossing	W10-1	450 dia.	18 dia.
Bicycle Crossing	W11-1	450 x 450	18 x 18
Low Clearance	W12-2	450 x 450	18 x 18
Share the Road Plaque	W16-1	600 x 750	24 x 30
Supplemental Bike Route Plaque	D1-1	600 x 150	24 x 6
Bicycle Parking	D4-3	300 x 450	12 x 18
Bike Route	D11-1	600 x 450	24 x 18
Bicycle Route Marker	M1-8	300 x 450	12 x 18
Bicycle Route Marker	M1-9	450 x 600	18 x 24
Supplemental Bicycle Route Guide	M4-11,12,13	300 x 100	12 x 4
Route Marker Supplemental Plaques	M7-1,2,3,4,5,6,7	300 x 225	12 x 9

Section 9B.03 STOP and YIELD Signs (R1-1, R1-2)**Standard:**

STOP (R1-1) signs shall be installed on shared-use paths at points where bicyclists are required to stop.

YIELD (R1-2) signs shall be installed on shared-use paths at points where bicyclists have an adequate view of conflicting traffic as they approach the sign, and where bicyclists are required to yield the right-of-way to that conflicting traffic.

Option:

A 750 x 750 mm (30 x 30 in) STOP sign or a 900 x 900 x 900 mm (36 x 36 x 36 in) YIELD sign may be used on shared-use paths for added emphasis.

Guidance:

Where conditions require bicyclists, but not drivers, to stop or yield, the STOP sign or YIELD sign should be placed or shielded so that it is not readily visible to drivers.

When considering STOP sign placement, assignment of priority at a shared-use path/roadway intersection should consider the following:

- A. Relative speeds of shared-use path and roadway users.
- B. Relative volumes of shared-use path and roadway traffic.
- C. Relative importance of shared-use path and roadway.

Speed should not be the sole factor used to determine priority, as it is sometimes appropriate to give priority to a high-volume shared-use path crossing a low-volume street, or to a regional shared-use path crossing a minor collector street.

When assigning priority, the least restrictive control that is appropriate should be placed on the lower priority approaches. STOP signs should not be used where YIELD signs would be acceptable.

Section 9B.04 Bicycle Lane Signs (R3-16, R3-17)**Standard:**

Bicycle Lane (R3-16 and R3-17) signs shall be used only in conjunction with the Bicycle Lane Symbol pavement marking.



R1-1



R1-2



R3-16



R3-16a



R3-17



R3-17a



R4-1



R4-2



R4-3



R4-4

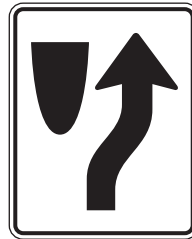

R4-7



R5-3



R5-6



R7-9



R7-9a



R9-3a



R9-5



R9-6



R9-7



R10-3



R15-1

Bicycle Lane signs shall be used in advance of the beginning of a marked bicycle lane to call attention to the lane and the possible presence of bicyclists.

Guidance:

The R3-17 sign should be installed at periodic intervals along the bicycle lane.

Option:

Where appropriate, the message ENDS may be substituted for AHEAD on the R3-16 sign. The words LEFT or CURB may be substituted for RIGHT on the R3-17 sign.

The R3-16a sign may be used to notify bicyclists that the bicycle lane is ending.

Where there is a lane used for parking along the bikeway, the R3-17a sign may be used to notify bicyclists that they may encounter parked vehicles.

Section 9B.05 BEGIN RIGHT TURN LANE YIELD TO BIKES Sign (R4-4)

Option:

Where motor vehicles entering an exclusive right-turn lane must weave across bicycle traffic in bicycle lanes, the BEGIN RIGHT TURN LANE YIELD TO BIKES (R4-4) sign may be used to inform both the driver and the bicyclist of this weaving maneuver.

Section 9B.06 NO MOTOR VEHICLES Sign (R5-3)

Option:

The NO MOTOR VEHICLES (R5-3) sign may be installed at the entrance to a shared-use path.

Section 9B.07 Bicycle Prohibition Sign (R5-6)

Guidance:

Where bicyclists are prohibited, the Bicycle Prohibition (R5-6) sign should be installed at the entrance to the facility.

Option:

Where pedestrians and motor-driven cycles are also prohibited, it may be more desirable to use the R5-10a word message sign that is described in Section 2B.31.

Section 9B.08 No Parking Bicycle Lane Signs (R7-9, R7-9a)

Standard:

If the installation of signs is necessary to restrict parking, standing, or stopping in a bicycle lane, appropriate signs as described in Sections 2B.34 through 2B.36, or the No Parking Bike Lane (R7-9 or R7-9a) signs shall be installed.

Section 9B.09 Bicycle Regulatory Signs (R9-5, R9-6)

Option:

Bicycle Regulatory signs may be installed where pedestrian facilities are being used for bicycle travel.

The R9-5 sign may be used where the crossing of a street by bicyclists is controlled by pedestrian signal indications.

Where it is not intended for bicyclists to be controlled by pedestrian signal indications, the R10-3 sign (see Section 2B.40) may be used.

The R9-6 sign may be used where a bicyclist is required to cross or share a facility used by pedestrians and is required to yield to the pedestrians.

Guidance:

If used, the R9-5 or R10-3 signs should be installed off the edge of the sidewalk, near the crossing location, where bicyclists will be crossing the street.

Section 9B.10 Shared-Use Path Restriction Sign (R9-7)

Option:

The Shared-Use Path Restriction (R9-7) sign may be installed on facilities that are to be shared by pedestrians and bicyclists. The symbols may be switched as appropriate.

A designated pavement area may be provided for each mode of travel (see Section 9C.03).

Section 9B.11 Other Regulatory Signs

Option:

Other regulatory signs described in Chapter 2B may be installed on bicycle facilities as appropriate.

Section 9B.12 Turn or Curve Warning Signs (W1 Series)**Guidance:**

To warn bicyclists of unexpected changes in shared-use path direction, appropriate turn or curve (W1-1 through W1-7) signs should be used.

The W1-1 through W1-5 signs should be installed no less than 15 m (50 ft) in advance of the beginning of the change of alignment.

Section 9B.13 Intersection Warning Signs (W2 Series)**Option:**

Intersection Warning (W2-1 through W2-5) signs may be used on a roadway, street, or shared-use path in advance of an intersection to indicate the presence of an intersection and the possibility of turning or entering traffic.

Guidance:

When engineering judgment determines that the visibility of the intersection is limited on the shared-use path approach, Intersection Warning signs should be used.

Intersection Warning signs should not be used when the shared-use path approach to the intersection is controlled by a STOP sign, YIELD sign, or a traffic control signal.

Section 9B.14 Bicycle Surface Condition Warning Sign (W8-10)**Option:**

The Bicycle Surface Condition Warning (W8-10) sign may be installed where roadway or shared-use path conditions could cause a bicyclist to lose control of the bicycle. A supplemental plaque may be used to clarify the specific type of surface condition.

Other surface conditions that might be of concern to bicyclists include SLIPPERY WHEN WET (W8-10p), BUMP (W8-1), DIP (W8-2), and Pavement Ends (W8-3), but other word message supplemental plaques that describe surface conditions that are of concern to bicyclists may also be used.



W1-1



W1-2



W1-3



W1-4



W1-5



W1-6

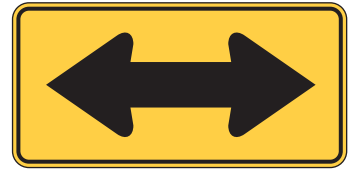

W1-7



W2-1



W2-2



W2-3



W2-4



W2-5



W3-1a



W3-2a



W3-3



W5-2a



W5-4



W7-5



W8-1



W8-2



W10-1



W12-2

OR



W8-10



W8-10p



W11-1



W11-1



W16-7



W11-1



W16-1

Section 9B.15 Bicycle Crossing Warning Sign (W11-1)**Support:**

The Bicycle Crossing Warning (W11-1) sign alerts the road user to unexpected entries into the roadway by bicyclists, and other crossing activities that might cause conflicts. These conflicts might be relatively confined, or might occur randomly over a segment of roadway.

Option:

A supplemental plaque with the legend AHEAD or XXX METERS (XXX FEET) may be used with the Bicycle Crossing Warning sign.

Guidance:

If used in advance of a specific crossing point, the Bicycle Crossing Warning sign should be placed at a distance in advance of the crossing location that conforms with the guidance given in Table 2C-4.

Standard:

Bicycle Crossing Warning signs, when used at the location of the crossing, shall be supplemented with a diagonal downward pointing arrow (W16-7) plaque to show the location of the crossing.

Option:

A fluorescent yellow-green background color with a black legend and border may be used for Bicycle Crossing Warning signs and supplemental plaques.

Guidance:

When the fluorescent yellow-green background color is used, a systematic approach featuring one background color within a zone or area should be used. The mixing of standard yellow and fluorescent yellow-green backgrounds within a zone or area should be avoided.

Section 9B.16 Other Bicycle Warning Signs**Option:**

Other bicycle warning signs such as BIKEWAY NARROWS (W5-4) and Hill (W7-5) may be installed on bicycle facilities to warn bicyclists of conditions not readily apparent.

In situations where there is a need to warn drivers to watch for bicyclists traveling along the highway, the SHARE THE ROAD (W16-1) plaque may be used in conjunction with the W11-1 sign.

Guidance:

If used, other advance bicycle warning signs should be installed no less than 15 m (50 ft) in advance of the beginning of the condition.

Where temporary traffic control zones are present on bikeways, appropriate signs from Part 6 should be used.

Option:

Other warning signs described in Chapter 2C may be installed on bicycle facilities as appropriate.

Section 9B.17 Bicycle Route Guide Signs (D11-1)

Guidance:

If used, Bicycle Route Guide (D11-1) signs should be provided at decision points along designated bicycle routes, including signs to inform bicyclists of bicycle route direction changes and confirmation signs for route direction, distance, and destination.

If used, Bicycle Route Guide signs should be repeated at regular intervals to ensure that bicyclists entering from side streets know that they are on a bicycle route. Similar guide signing should be used for shared roadways with intermediate signs placed for bicyclist guidance.

Support:

Figure 9B-2 shows an example of the signing for the junction of a bicycle route with a highway. Figure 9B-3 shows an example of signing and marking for the intersection of a shared-use path with a roadway.

Section 9B.18 Bicycle Route Markers (M1-8, M1-9)

Option:

To establish a unique identification (route designation) for a state or local bicycle route, the Bicycle Route (M1-8) marker may be used.



D11-1



M1-8



M1-9



D1-1b(L)



M4-11



D1-1b(R)



M4-12



D1-1c



M4-13



M7-1



M7-2



M7-3



M7-4



M7-5



M7-6



M7-7



D4-3

Figure 9B-2. Typical Signing for the Beginning and End of a Bicycle Route

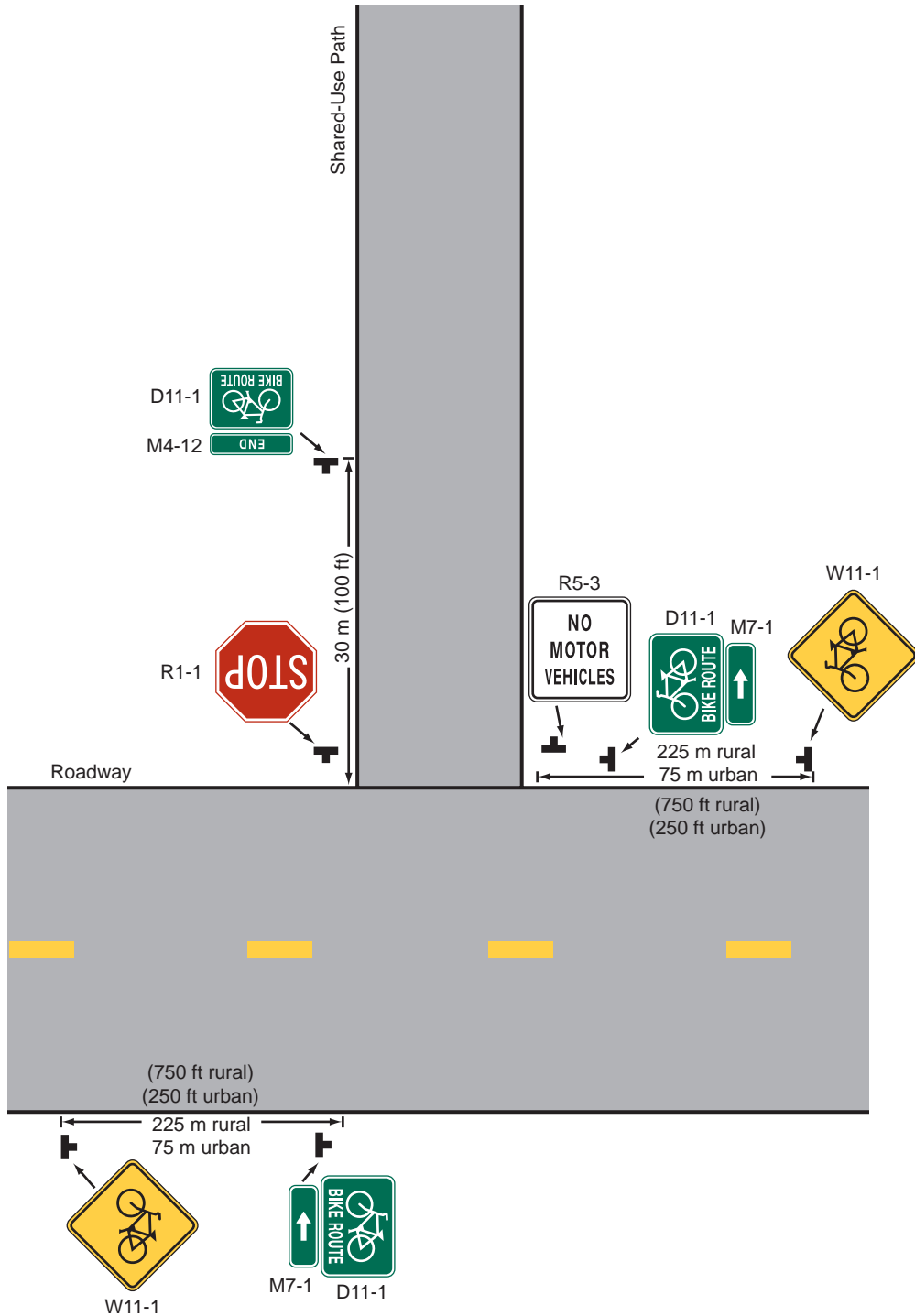
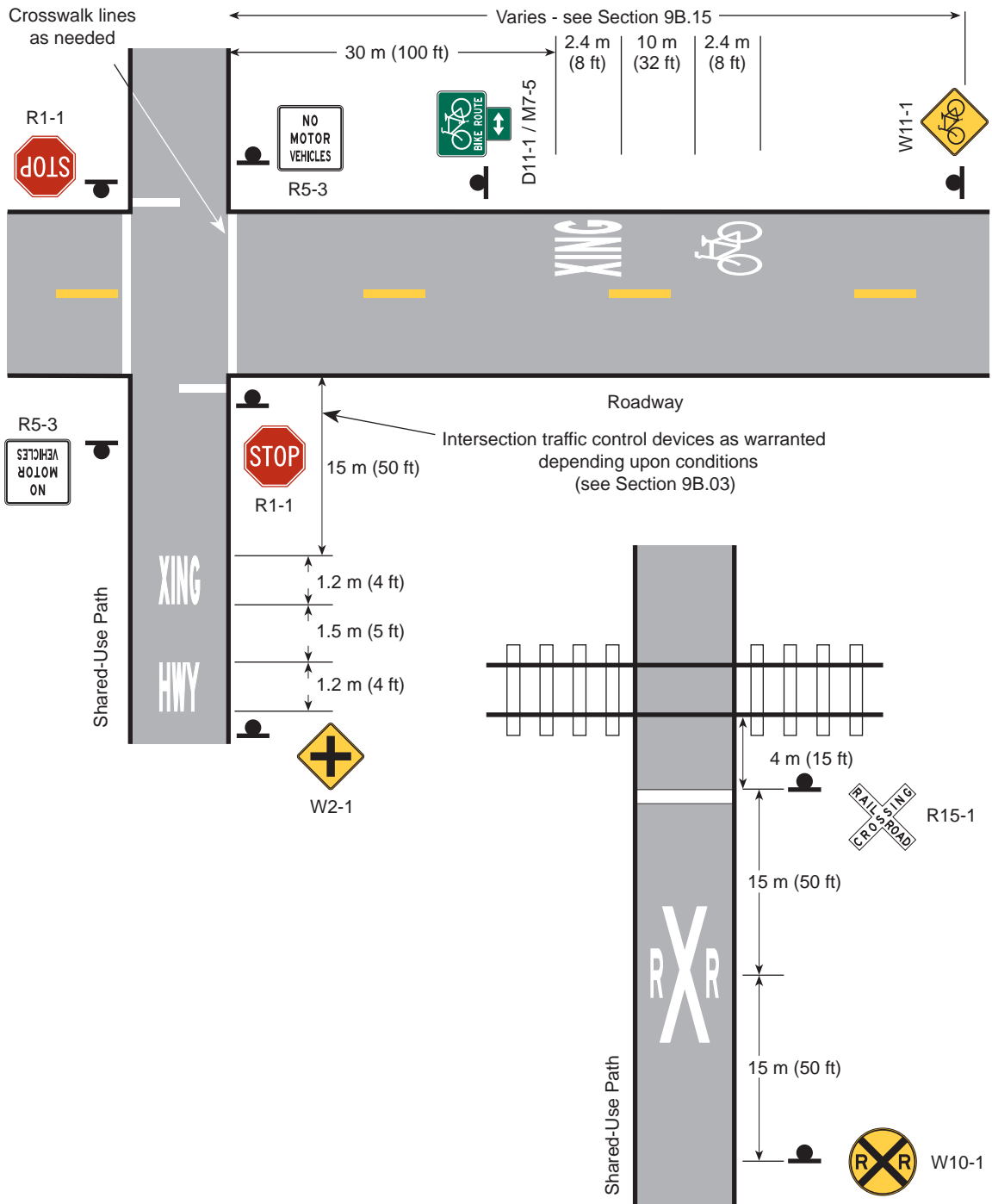

Figure 9B-3. Typical Signs and Markings for Shared-Use Paths



Standard:

The Bicycle Route marker shall contain a route designation and shall have a green background with a retroreflectorized white legend and border.

Option:

Where a designated bicycle route extends for long distances through two or more states, a coordinated submittal by the affected states for an assignment of an Interstate Bicycle Route number designation may be sent to the American Association of State Highway and Transportation Officials (see Page i for the address).

Standard:

The Interstate Bicycle Route (M1-9) marker shall contain the assigned route number designation and have a black legend and border with a retroreflectorized white background.

Guidance:

If used, the Bicycle Route or Interstate Bicycle Route markers should be placed at intervals frequent enough to keep bicyclists informed of changes in route direction and to remind drivers of the presence of bicyclists.

Option:

Bicycle Route or Interstate Bicycle Route markers may be installed on shared roadways or on shared-use paths to provide guidance for bicyclists.

The Bicycle Route Guide (D11-1) sign may be installed where no unique designation of routes is desired.

Section 9B.19 Destination Arrow and Supplemental Plaque Signs for Bicycle Route Signs

Option:

Destination (D1-1b and D1-1c) signs may be installed with Bicycle Route Guide signs, Bicycle Route markers, or Interstate Bicycle Route markers to furnish additional information, such as directional changes in the route, or intermittent distance and destination information.

The M4-11 through M4-13 supplemental plaques may be mounted above the appropriate Bicycle Route Guide signs, Bicycle Route markers, or Interstate Bicycle Route markers.

Guidance:

If used, the appropriate arrow (M7-1 through M7-7) sign should be placed below the Bicycle Route Guide sign, Bicycle Route marker, or Interstate Bicycle Route marker.

Standard:

The arrow signs and supplemental plaques used with the D11-1 or M1-8 signs shall have a white legend and border on a green background.

The arrow signs and supplemental plaques used with the M1-9 sign shall have a white legend and border on a black background.

Section 9B.20 Bicycle Parking Area Sign (D4-3)

Option:

The Bicycle Parking Area (D4-3) sign may be installed where it is desirable to show the direction to a designated bicycle parking area.

Standard:

The legend and border of the Bicycle Parking Area sign shall be green on a retroreflectorized white background.

CHAPTER 9C. MARKINGS

Section 9C.01 Functions of Markings

Support:

Markings are important on roadways that have a designated bicycle lane. Markings indicate the separation of the lanes for road users, assist the bicyclist by indicating assigned travel paths, indicate correct position for traffic signal actuation, and provide advance information for turning and crossing maneuvers.

Section 9C.02 General Principles

Guidance:

Bikeway design guides should be used when designing markings for bicycle facilities (see Section 9A.05).

Standard:

Markings used on bikeways shall be retroreflectorized.

Guidance:

Pavement marking symbols and/or word messages should be used in the bicycle lanes. Consideration should be given to selecting pavement marking materials that will minimize loss of traction for bicycles in wet conditions.

Support:

Figures 9C-1 through 9C-7 show examples of the application of lines, word messages, and symbols on designated bikeways with and without parking for motor vehicles.

Option:

A dotted line may be used to define a specific path for a bicyclist crossing an intersection (see Figure 9C-1) as described in Sections 3A.05, 3A.06, and 3B.08.

Figure 9C-1. Typical Intersection Pavement Markings-Designated Bicycle Lane with Left-Turn Area, Heavy Turn Volumes, Parking, One-Way Traffic, or Divided Highway

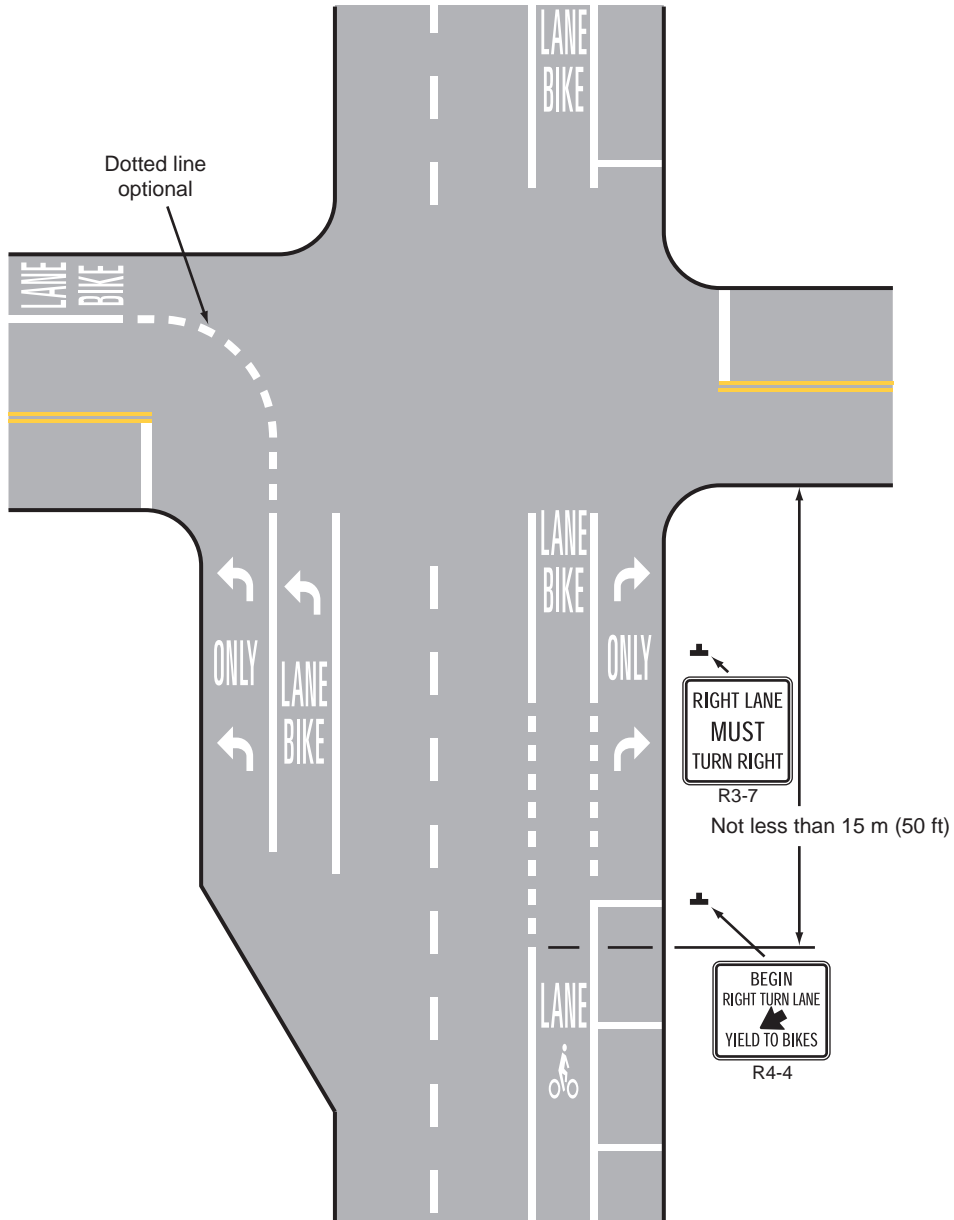

Section 9C.03 Marking Patterns and Colors on Shared-Use Paths

Standard:

The color, symbols, size, and types of lines used for marking bicycle facilities shall be as defined in Sections 3A.05, 3A.06, and 3B.22.

Support:

In most cases, centerlines are not required on shared-use paths.

Option:

Where shared-use paths are of sufficient width to designate two minimum width lanes, a solid yellow line may be used to separate the two directions of travel where passing is not permitted, and a broken yellow line may be used where passing is permitted (see Figure 9C-2).

Guidance:

Broken lines used on shared-use paths should have the usual 1-to-3 segment-to-gap ratio. A nominal 0.9 m (3 ft) segment with a 2.7 m (9 ft) gap should be used.

If conditions make it desirable to separate two directions of travel on shared-use paths at particular locations, a solid yellow line should be used to indicate no passing and no traveling to the left of the line.

Option:

On shared-use paths, a solid white line may be used to separate different types of users. The R9-7 sign may be used to supplement the solid white line.

Section 9C.04 Markings For Bicycle Lanes

Guidance:

Longitudinal pavement markings should be used to define bicycle lanes.

Support:

Pavement markings supplement signs to designate that portion of the roadway for preferential or exclusive use by bicyclists. Markings inform all road users of the restricted nature of the bicycle lane.

Figure 9C-2. Centerline Markings for Shared-Use Paths

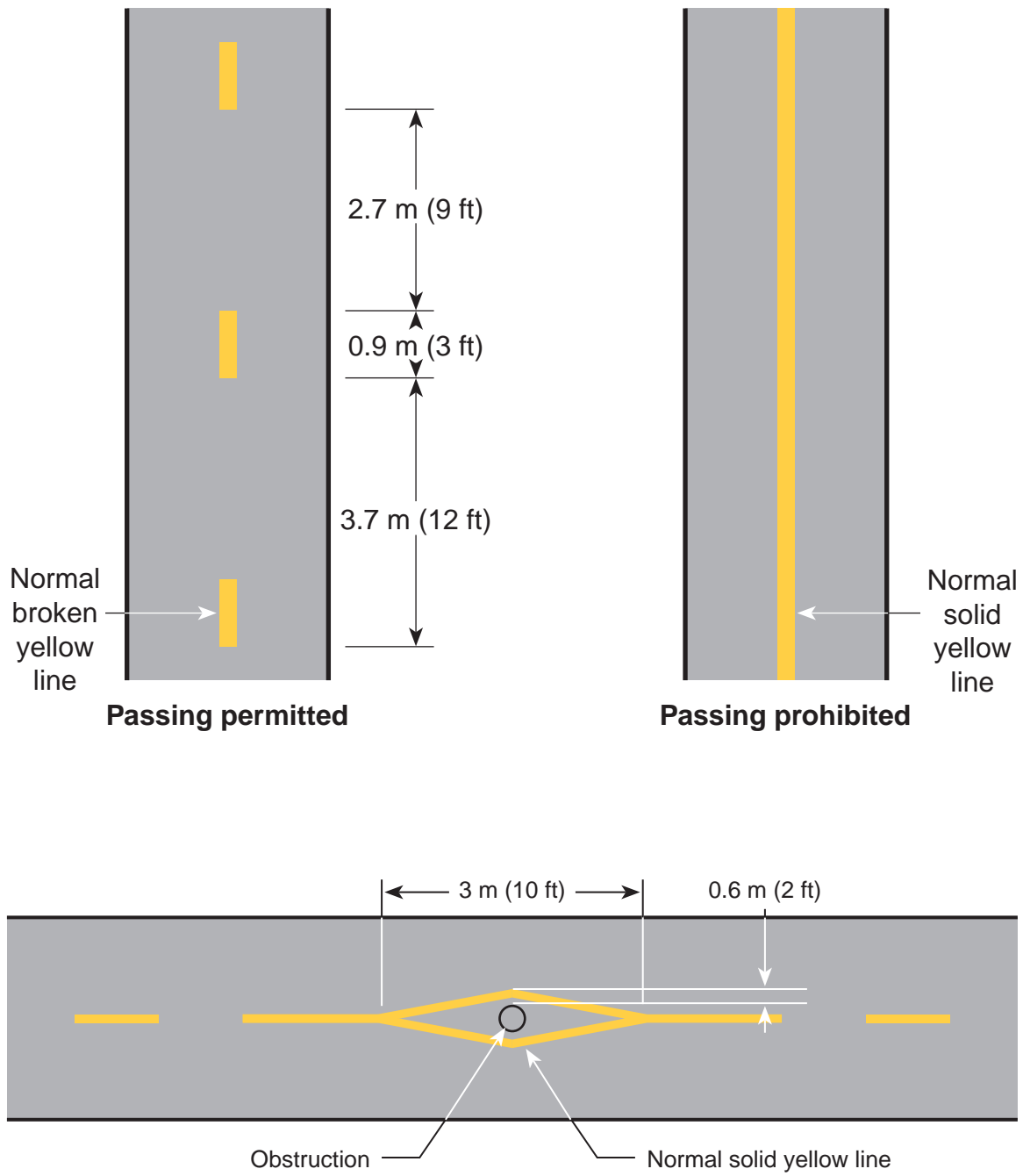

Standard:

If used, the bicycle lane symbol shall be placed immediately after but not closer than 20 m (65 ft) from the crossroad, or other locations as needed. The bicycle lane symbol marking shall be white. If the bicycle lane symbol is used in conjunction with other word or symbol messages, it shall precede them.

Signs shall be used with preferential lane symbols.

Support:

Typical bicycle lane markings at right-turn lanes are shown in Figures 9C-3 and 9C-4. Typical pavement markings for bicycle lanes on a two-way street are shown in Figure 9C-5.

Section 9C.05 Word Messages and Symbols Applied to the Pavement

Option:

Optional word and symbol markings shown in Figure 9C-6 may be used.

Smaller size letters and symbols may be used on shared-use paths. Where arrows are needed on shared-use paths, half-size layouts of the arrows may be used (see Section 3B.19).

Section 9C.06 Object Markers on Shared-Use Paths

Option:

Fixed objects adjacent to shared-use paths may be marked with object markers (Type 1, 2, or 3).



Type 1



Type 2



Type 3

Figure 9C-3. Typical Bicycle Lane Treatment at a Right Turn Only Lane

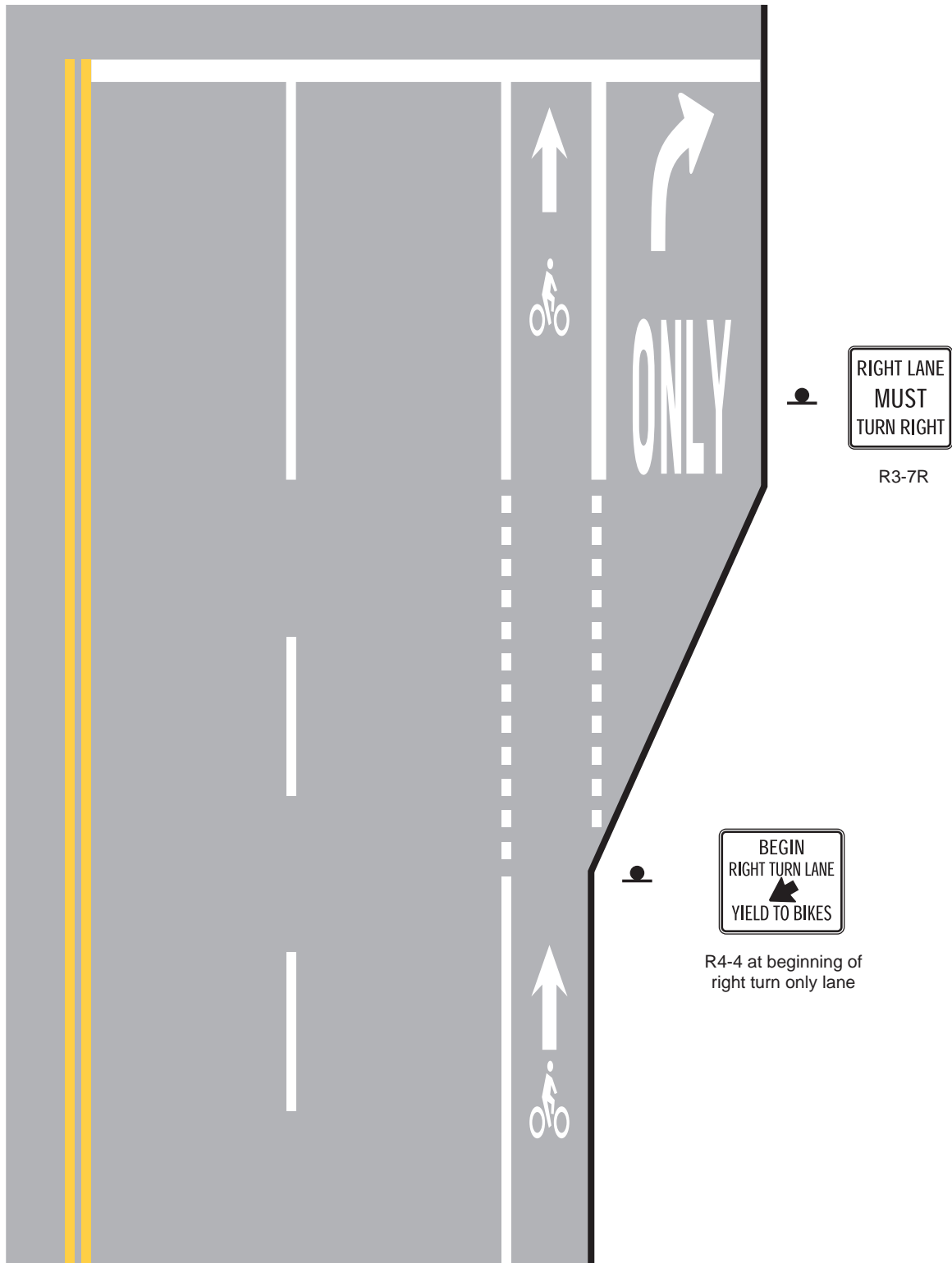

Figure 9C-4. Typical Bicycle Lane Treatment at Parking Lane Into a Right Turn Only Lane

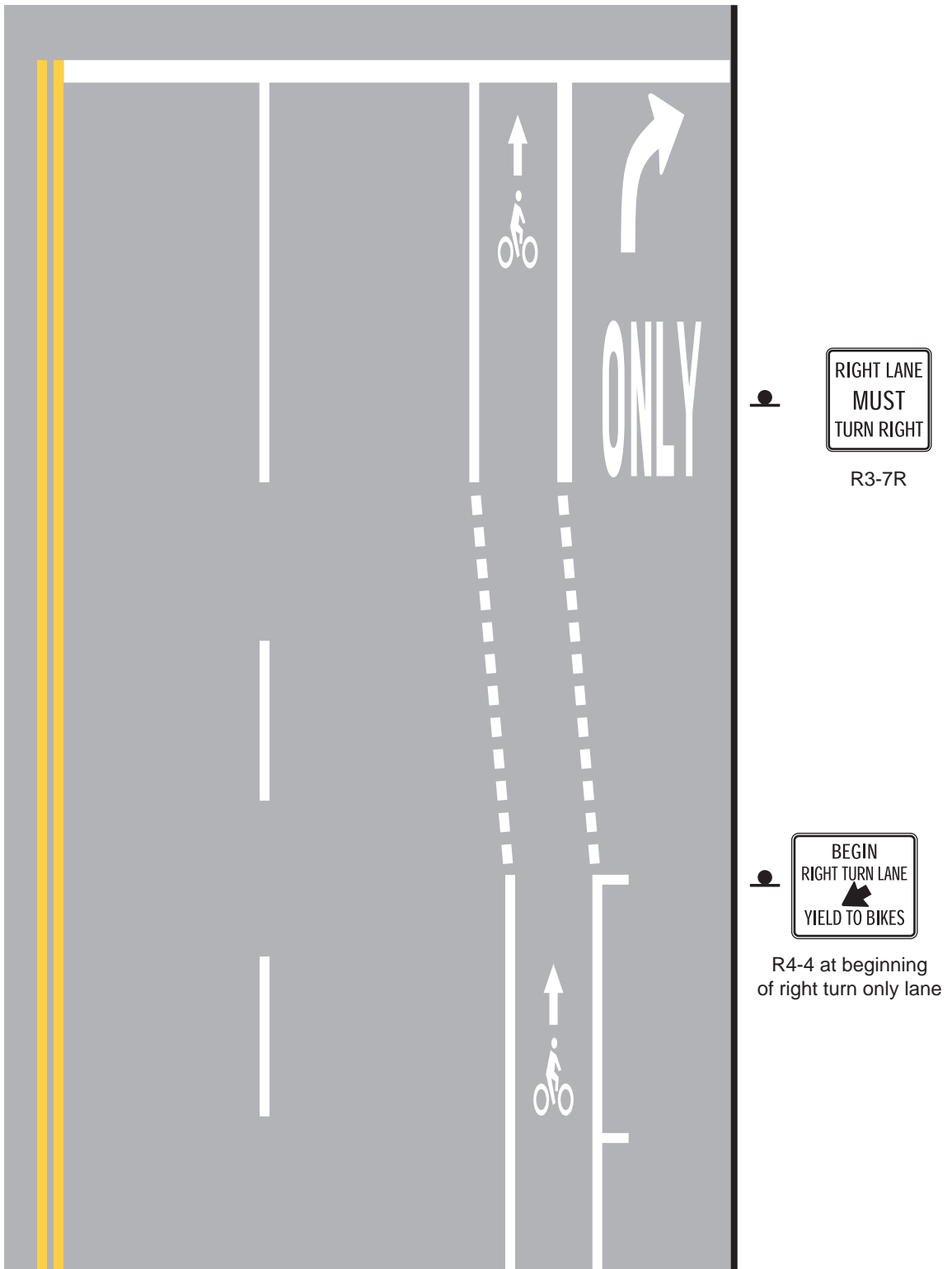

Figure 9C-5. Typical Pavement Markings for Bicycle Lanes on a Two-Way Street

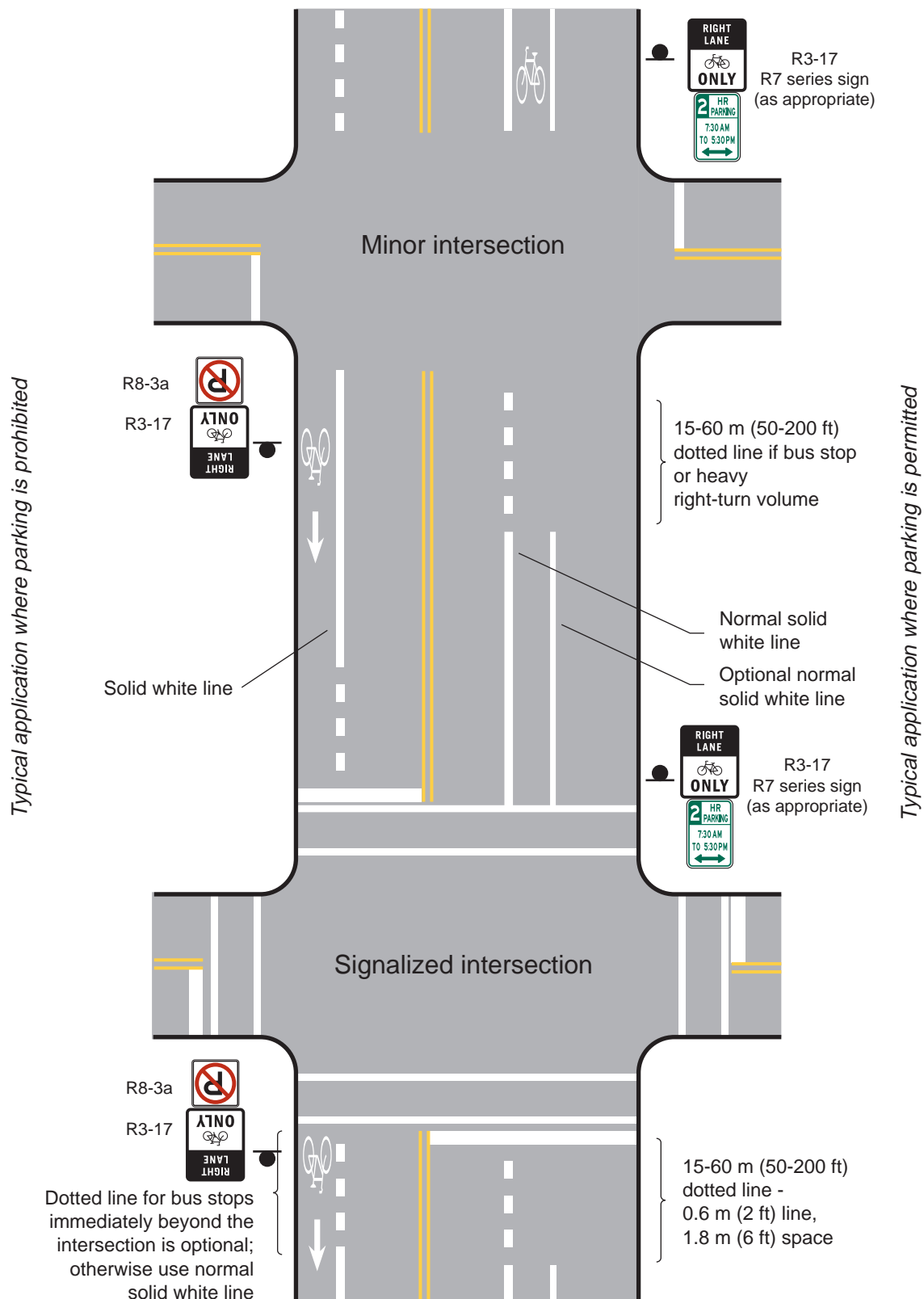
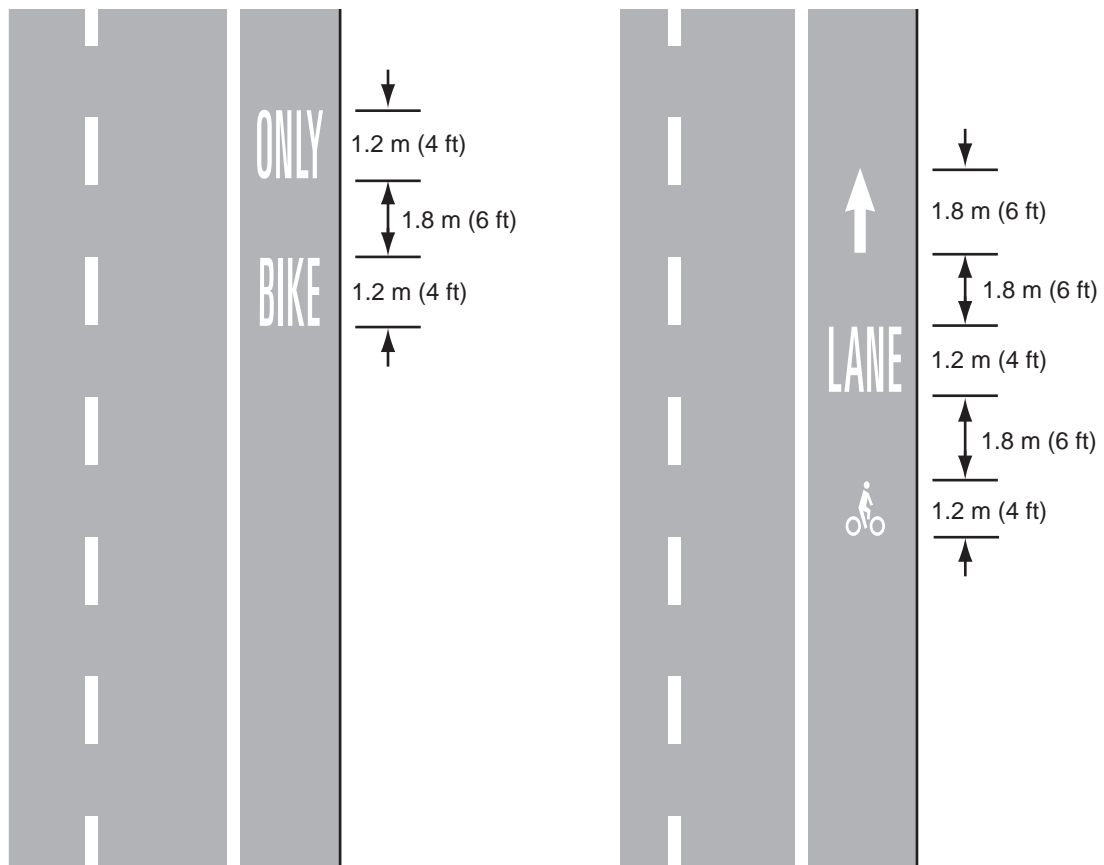

Figure 9C-6. Typical Optional Word and Symbol Pavement Markings for Bicycle Lanes



Standard:

All object markers shall be retroreflective.

Markers such as those described in Section 3C.01 shall also be used on shared-use paths, if needed.

As indicated in Section 3C.02, obstructions within the bikeway shall be marked with the appropriate object marker or delineation.

On Type 3 markers, the alternating black and retroreflective yellow stripes shall be sloped down at an angle of 45 degrees toward the side on which traffic is to pass the obstruction.

Section 9C.07 Pavement Markings for Obstructions

Guidance:

In roadway situations where a drain grate or other roadway obstruction that is inappropriate for bicycle travel cannot be eliminated, white markings applied as shown in Figure 9C-7 should be used.

Figure 9C-7. Typical Obstruction Pavement Marking

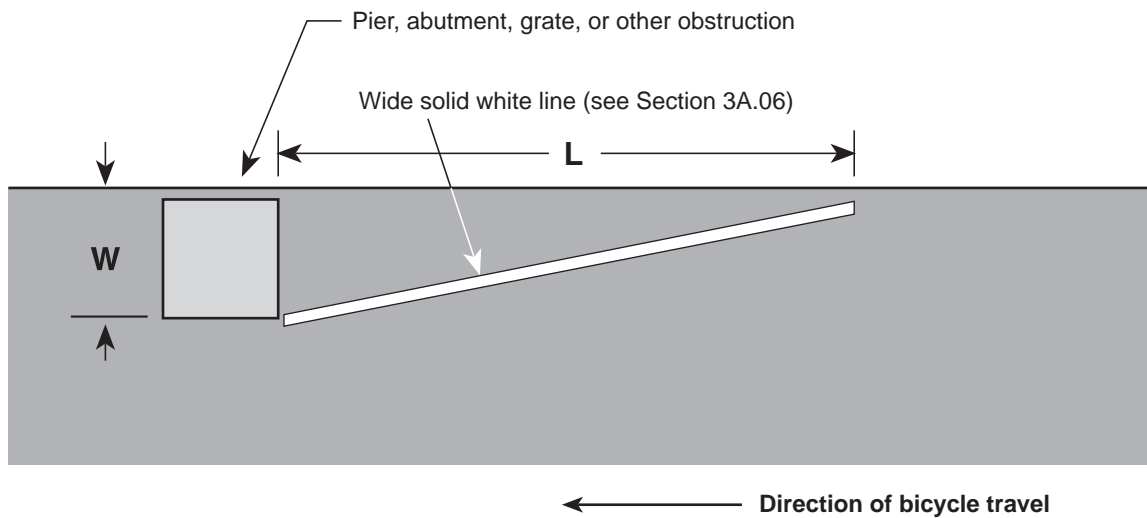

For metric units:

$L = 0.6 WS$, where S is bicycle approach speed in kilometers per hour

For English units:

$L = WS$, where S is bicycle approach speed in miles per hour

CHAPTER 9D. SIGNALS

Section 9D.01 Application

Support:

Part 4 contains information regarding signal warrants and other requirements relating to signal installations.

Option:

For purposes of signal warrant evaluation, bicyclists may be counted as either vehicles or pedestrians.

Section 9D.02 Signal Operations for Bicycles

Standard:

At installations where visibility-limited signal faces are used, signal faces shall be adjusted so bicyclists for whom the indications are intended can see the signal indications. If the visibility-limited signal faces cannot be aimed to serve the bicyclist, then separate signal faces shall be provided for the bicyclist.

On bikeways, the needs of bicyclists shall be considered when setting signal timing.

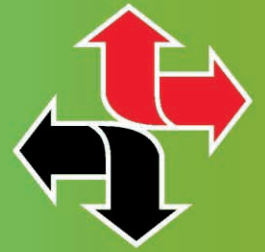

PART 10

Traffic Controls for Highway-Light Rail Transit Grade Crossings

MUTCD 2000

Manual on Uniform Traffic Control Devices

m i l l e n n i u m e d i t i o n

December 2000



U.S. Department
of Transportation

**Federal Highway
Administration**

PART 10. TRAFFIC CONTROLS FOR HIGHWAY-LIGHT RAIL TRANSIT GRADE CROSSINGS

TABLE OF CONTENTS

	<u>Page</u>
CHAPTER 10A. GENERAL	Dec., 2000
Section 10A.01 Introduction	10A-1
Section 10A.02 Use of Standard Devices, Systems, and Practices	10A-2
Section 10A.03 Uniform Provisions	10A-2
Section 10A.04 Highway-Light Rail Transit Grade Crossing Elimination	10A-3
Section 10A.05 Temporary Traffic Control Zones	10A-3
CHAPTER 10B. HIGHWAY-LIGHT RAIL TRANSIT GRADE CROSSING CONTROL SYSTEMS	Dec., 2000
Section 10B.01 Introduction.....	10B-1
CHAPTER 10C. SIGNS, ILLUMINATION, AND MARKINGS	Dec., 2000
Section 10C.01 Introduction.....	10C-1
Section 10C.02 LOOK Sign (R15-8).....	10C-1
Section 10C.03 STOP or YIELD Signs (R1-1, R1-2, W3-1a, W3-2a).....	10C-1
Section 10C.04 DO NOT STOP ON TRACKS Sign (R8-8).....	10C-2
Section 10C.05 STOP HERE ON RED Sign (R10-6)	10C-2
Section 10C.06 Light Rail Transit-Activated Blank-Out Turn Prohibition Signs (R3-1a , R3-2a).....	10C-4
Section 10C.07 Divided Highway With Light Rail Transit Crossing Signs (R15-7 Series).....	10C-4
Section 10C.08 No Vehicles On Tracks Signs (R15-6, R15-6a)	10C-5
Section 10C.09 Light Rail Transit Only Lane Signs (R15-4 Series).....	10C-5
Section 10C.10 Do Not Pass Light Rail Transit Signs (R15-5, R15-5a).....	10C-6
Section 10C.11 Highway-Rail Advance Warning Signs (W10 Series)	10C-8
Section 10C.12 Light Rail Transit Approaching-Activated Blank-Out Warning Sign (W10-7).....	10C-9
Section 10C.13 Light Rail Station Sign (I-12).....	10C-9
Section 10C.14 Illumination at Highway-Light Rail Transit Crossings	10C-9
Section 10C.15 Dynamic Envelope Delineation Markings	10C-9
CHAPTER 10D. HIGHWAY-LIGHT RAIL TRANSIT ACTIVE TRAFFIC CONTROL GRADE CROSSING SYSTEMS	Dec., 2000
Section 10D.01 Introduction	10D-1
Section 10D.02 Four-Quadrant Gate Systems	10D-2
Section 10D.03 Automatic Gates	10D-3
Section 10D.04 Flashing-Light Signals	10D-4

Section 10D.05 Traffic Control Signals10D-5
 Section 10D.06 Traffic Signal Preemption Turning Restrictions10D-6
 Section 10D.07 Use of Traffic Control Signals for Control of Light Rail Transit
 Vehicles at Grade Crossings.....10D-7
 Section 10D.08 Pedestrian and Bicycle Signals and Crossings.....10D-9

FIGURES

CHAPTER 10C. SIGNS, ILLUMINATION, AND MARKINGS

Figure 10C-1 Light Rail Transit Vehicle Dynamic Envelope.....10C-10
 Figure 10C-2 Typical Light Rail Transit Vehicle Dynamic Envelope
 Delineation Pavement Markings10C-10
 Figure 10C-3 Typical Light Rail Transit Car Dynamic Envelope
 Delineation Pavement Markings10C-12
 Figure 10C-4 Typical Light Rail Transit Vehicle Dynamic Envelope
 Delineation Contrasting Pavement Texture.....10C-12

CHAPTER 10D. HIGHWAY-LIGHT RAIL TRANSIT ACTIVE TRAFFIC CONTROL GRADE CROSSING SYSTEMS

Figure 10D-1 Typical Light Rail Transit Signals.....10D-8
 Figure 10D-2 Typical Light Rail Transit Flashing-Light Signal Assembly
 for Pedestrian Crossings.....10D-10
 Figure 10D-3 Typical Pedestrian Gate Placement Behind the Sidewalk.....10D-11
 Figure 10D-4 Typical Pedestrian Gate Placement with Pedestrian Gate Arm10D-11
 Figure 10D-5 Typical Placement of Pedestrian Traffic Gates10D-12
 Figure 10D-6 Typical Swing Gates.....10D-13
 Figure 10D-7 Typical Pedestrian Barriers at an Offset Highway - Light Rail
 Transit Crossing.....10D-13
 Figure 10D-8 Typical Examples of Pedestrian Barrier Installation at an Offset
 Non-Intersection Light Rail Transit Crossing10D-14

CHAPTER 10A. GENERAL

Section 10A.01 Introduction

Support:

Part 10 provides standards and guidelines for the design, installation, and operation of traffic control devices at grade crossings of highway traffic and light rail transit vehicles to facilitate the safe, orderly, and integrated movement of all traffic. The principles in Section 8A.01 are the same but, because light rail vehicles sometimes operate along streets and highways in mixed traffic with automotive vehicles, the traffic controls and associated standards and guidelines for highway-light rail transit vehicle grade crossings presented in Part 10 can be different than those presented in Part 8.

Light rail transit is a mode of metropolitan transportation that employs light rail transit cars (commonly known as light rail vehicles, streetcars, or trolleys) that operate on rails in streets in mixed traffic, in semi-exclusive rights-of-way, or in exclusive rights-of-way. Grade crossings with light rail transit can occur at intersections or at mid-block locations, including public and private driveways.

An initial educational campaign along with an ongoing program to continue to educate new drivers is beneficial when introducing light rail operations to an area and, hence, new traffic control devices.

Light rail alignments can be grouped into one of the following three types:

- A. Exclusive: A light rail transit right-of-way that is grade-separated or protected by a fence or traffic barrier. Motor vehicles, pedestrians, and bicycles are prohibited within the right-of-way. Subways and aerial structures are included within this group. This type of alignment does not have grade crossings and is not further addressed in Part 10.
- B. Semi-Exclusive: A light rail transit alignment that is in a separate right-of-way or along a street or railroad right-of-way where motor vehicles, pedestrians, and bicycles have limited access and cross at designated locations only.
- C. Mixed-Use: An alignment where light rail transit operates in mixed traffic with all types of road users. This includes streets, transit malls, and pedestrian malls where the right-of-way is shared.

Standard:

Where light rail transit and railroads use the same tracks or adjacent tracks, the traffic control devices, systems, and practices for highway-rail grade crossings described in Part 8 shall be used.

Section 10A.02 Use of Standard Devices, Systems, and Practices

Support:

Because of the large number of significant variables to be considered, no single standard system of active traffic control devices is universally applicable for all highway-light rail transit grade crossings.

Guidance:

The appropriate traffic control system required at a highway-light rail transit grade crossing should be determined by an engineering study.

Standard:

Traffic control devices, systems, and practices shall be consistent with the design and application of the Standards contained herein.

The traffic control devices, systems, and practices described herein shall be used at all highway-light rail transit grade crossings.

Before any new highway-light rail transit grade crossing traffic control system is installed or modifications are made to an existing system, approval shall be obtained from the local agencies having statutory authority to grant such approval.

Guidance:

To stimulate effective responses from drivers, pedestrians, and bicyclists, these devices, systems, and practices should use the five basic considerations employed generally for traffic control devices and described fully in Section 1A.02: design, placement, operation, maintenance, and uniformity.

Support:

Many other details of highway-light rail transit grade crossing traffic control systems which are not set forth in Part 10 are contained in the references listed in Section 1A.11.

Section 10A.03 Uniform Provisions

Standard:

All signs used in grade crossing traffic control systems shall be retroreflectorized or illuminated as described in Section 2A.08 to show the same shape and color to an approaching road user both by day and night.

Guidance:

Such signs or signals should be installed with a clearance of at least 0.6 m (2 ft) from the face of the curb to the edge of the sign or signal head, except as allowed in Section 2A.19.

Section 10A.04 Highway-Light Rail Transit Grade Crossing Elimination**Guidance:**

Since highway-light rail transit grade crossings are a potential source of congestion, agencies should conduct engineering studies to determine the cost and benefits of eliminating these crossings.

Standard:

When a highway-light rail transit grade crossing is eliminated, the traffic control devices for the crossing shall be removed.

Guidance:

Where a roadway is removed from a grade crossing, the roadway approaches in the light rail transit right-of-way should also be removed or barricaded.

Where light rail transit is eliminated at a highway-light rail transit grade crossing, the tracks should be removed or paved over.

At multiple track crossings, if one or more tracks are eliminated, existing traffic control devices should be removed or modified, as appropriate.

Option:

The TRACKS OUT OF SERVICE (R8-9) sign may be temporarily installed until the tracks are removed or paved over.

Section 10A.05 Temporary Traffic Control Zones**Support:**

Temporary traffic control planning provides for continuity of operations (such as movement of traffic, pedestrians and bicycles, transit operations, and access to property/utilities) when the normal function of a roadway at a highway-light rail transit grade crossing is suspended because of temporary traffic control operations.

Standard:

Temporary traffic control operations on highways with highway-light rail transit grade crossings shall be as outlined in Part 6.

Guidance:

The agencies responsible for the operation of the light rail transit and highway should be contacted when the initial planning begins for any temporary traffic control zone that may directly or indirectly influence the flow of traffic on mixed-use facilities where light rail transit and road users operate. Responsible agencies, along with others affected, such as emergency services and businesses, should meet to plan appropriate traffic detours, necessary signing, marking, and flagging requirements for operations during temporary traffic control activities.

Considerations should include length of time for the crossing to be closed, roadway classification, type of vehicle and traffic affected, time of day, roadway materials, and techniques of repair.

Temporary traffic control operations should minimize the inconvenience, delay, and crash potential to affected traffic. Prior notice should be given to affected public or private parties, including emergency services and businesses, before blockage or infringement of the free movement of vehicles or light rail transit.

Temporary traffic control activities should not be permitted to cause prolonged closing of a crossing.

Standard:

When a highway-rail grade crossing exists either within or in the vicinity of a temporary traffic control zone, lane restrictions, flagging, or other operations shall not be performed in a manner that would cause vehicles to stop on the railroad tracks, unless a law enforcement officer or flagger is provided at the highway-rail grade crossing to minimize the possibility of vehicles stopping on the tracks, even if automatic warning devices are in place.

CHAPTER 10B. HIGHWAY-LIGHT RAIL TRANSIT GRADE CROSSING CONTROL SYSTEMS

Section 10B.01 Introduction

Support:

The combination of devices selected or installed at a specific highway-light rail transit grade crossing is referred to as a Light Rail Transit Traffic Control System.

For the safety and integrity of operations by highway and light rail transit users, the highway agency with jurisdiction, the regulatory agency with statutory authority, if applicable, and the light rail transit authority jointly determine the need and selection of traffic control devices and the assignment of priority to light rail transit at a highway-light rail transit grade crossing.

The normal rules of the road and traffic control priority identified in the Uniform Vehicle Code govern the order assigned to the movement of vehicles at an intersection unless the local agency determines that it is appropriate to assign a higher priority to light rail transit. Examples of different types of light rail transit priority control include separate traffic signal phases for light rail transit movements, restriction of movement of roadway vehicles in favor of light rail transit operations, and preemption of roadway traffic signal control to accommodate light rail transit movements.

Standard:

Highway-light rail transit grade crossings in semi-exclusive alignments shall be equipped with a combination of traffic gates and flashing-light signals, or flashing-light signals only, or traffic control signals, unless an engineering study indicates that the use of STOP, YIELD, or advance warning signs alone would be adequate.

Option:

Highway-light rail transit grade crossings in mixed-use alignments may be equipped with traffic control signals unless an engineering study indicates that the use of STOP, YIELD, or advance warning signs alone would be adequate.

Support:

Section 10C.03 describes the appropriate conditions for the use of STOP or YIELD signs alone at a highway-light rail transit grade crossing.

CHAPTER 10C. SIGNS, ILLUMINATION, AND MARKINGS

Section 10C.01 Introduction

Support:

Signs and markings regulate, warn, and guide the road users so that they, as well as light rail transit car operators, can take appropriate action.

Standard:

The design and location of signs shall conform to Chapter 2A.

Section 10C.02 LOOK Sign (R15-8)

Option:

A LOOK (for light rail transit vehicles) (R15-8) sign may be mounted at highway-light rail grade crossings.

The LOOK sign may be mounted as a supplemental panel on the Crossbuck (R15-1) sign post, or as a separate sign in the immediate vicinity of the highway-light rail grade crossing on the light-rail transit right-of-way.

Section 10C.03 STOP or YIELD Signs (R1-1, R1-2, W3-1a, W3-2a)

Standard:

For all highway-light rail transit crossings where STOP (R1-1) or YIELD (R1-2) signs are installed, the placement shall conform to the requirements of Sections 2B.06 and 2B.10. Stop Ahead (W3-1a) or Yield Ahead (W3-2a) Advance Warning signs shall also be installed in accordance with Section 2C.26.

Guidance:

The use of STOP or YIELD signs for road users at highway-light rail transit grade crossings should be limited to those crossings where the need and feasibility is established by an engineering study. Such crossings should have all of the following characteristics:

- A. The crossing roadways should be secondary in character (such as a minor street with one lane in each direction, an alley, or a driveway) with low traffic volumes and low speed limits.

- B. The road user has sufficient sight distance at the stop line to permit the vehicle to cross the tracks before the arrival of the light rail transit vehicle.
- C. If at an intersection of two roadways, the intersection does not meet the warrants for a traffic control signal as specified in Chapter 4C.

If a STOP or YIELD sign is installed beyond the light rail transit crossing such that vehicle queues are likely to extend into the path of the light rail transit, a DO NOT STOP ON TRACKS sign (R8-8) should be posted in accordance with Section 10C.04.

Option:

When a STOP or YIELD sign is installed at a highway-light rail transit grade crossing, it may be installed on the Crossbuck post or on a separate post at the point where the vehicle is to stop, or as near thereto as practical.

Section 10C.04 DO NOT STOP ON TRACKS Sign (R8-8)

Guidance:

A DO NOT STOP ON TRACKS (R8-8) sign should be installed whenever an engineering study determines that the potential for vehicles stopping on the tracks at a highway-light rail transit crossing is significant. Placement of the R8-8 sign should be determined as part of the engineering study. The sign, if used, should be located on the right side of the road on either the near or far side of the grade crossing. The decision as to placing the sign on the near or far side should be based upon which position provides better visibility to the road users to observe the sign and be able to comply with its message.

Option:

On divided highways and one-way streets, a second sign may be placed on the left side of the road at the grade crossing to further improve visibility of the sign.

Section 10C.05 STOP HERE ON RED Sign (R10-6)

Support:

The STOP HERE ON RED (R10-6) sign defines and facilitates observance of the stop lines at traffic signals or traffic gates.

Option:

A STOP HERE ON RED sign may be used at locations where vehicles frequently violate the stop line or where it is not obvious to road users where to stop.



R15-8



R8-8



R10-6



R3-1a
Activated Blank-Out



R3-2a
Activated Blank-Out



R15-7

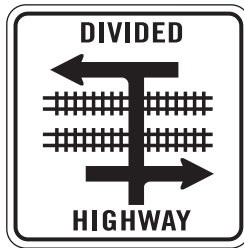

R15-7a



R15-6



R15-6a



R15-4a



R15-4b



R15-4c

Guidance:

If possible, stop lines should be placed at a point where the vehicle driver has adequate sight distance along the track.

Section 10C.06 Light Rail Transit-Activated Blank-Out Turn Prohibition Signs (R3-1a, R3-2a)**Support:**

Light rail transit operations can include the use of activated blank-out sign technology for turn prohibition signs (R3-1a, R3-2a). The signs are typically used on roads paralleling a semi-exclusive or mixed-use light rail transit alignment where road users might turn across the light rail transit tracks. A blank-out sign displays its message only when activated. When not activated, the sign face is blank.

Guidance:

A light rail transit-activated blank-out turn prohibition sign should be used where an intersection adjacent to a highway-light rail transit crossing is controlled by STOP signs, or is controlled by traffic control signals with permissive turn movements for road users crossing the tracks.

Option:

A light rail transit-activated blank-out turn prohibition sign may be used for turning movements that cross the tracks.

As an alternative to light rail transit-activated blank-out turn prohibition signs at intersections with traffic control signals, exclusive traffic control signal phases such that all movements that cross the tracks have a red indication may be used in combination with NO TURN ON RED (R10-11a) signs.

Section 10C.07 Divided Highway With Light Rail Transit Crossing Signs (R15-7 Series)**Option:**

The Divided Highway With Light Rail Transit Crossing (R15-7) sign may be used as a supplemental sign on the approach legs of a roadway that intersects with a divided highway where light rail transit cars operate in the median. The sign may be placed beneath a STOP sign or mounted separately.

Guidance:

The number of tracks shown on the R15-7 sign should be the same as the actual number of tracks.

Standard:

When the Divided Highway With Light Rail Transit Crossing sign is used at a four-legged intersection, the R15-7 sign shall be used. When used at a T-intersection, the R15-7a sign shall be used.

Section 10C.08 No Vehicles On Tracks Signs (R15-6, R15-6a)**Support:**

The No Vehicles On Tracks (R15-6) sign is used where there are adjacent traffic lanes separated from the light rail transit lane by a curb or pavement markings.

Guidance:

The DO NOT ENTER (R5-1) sign should be used where a road user could wrongly enter a light rail transit only street.

Option:

A No Vehicles On Tracks sign may be used to deter vehicles from driving on the trackway. It may be installed either on a 1 m (3 ft) flexible post between double tracks, on a post alongside the tracks, or overhead.

Instead of the R15-6 symbol sign, a regulatory sign with the word message DO NOT DRIVE ON TRACKS (R15-6a) may be used.

A reduced size of 300 x 300 mm (12 x 12 in) may be used if the R15-6 sign is installed between double tracks.

Standard:

The smallest size for the R15-6 sign shall be 300 x 300 mm (12 x 12 in).

Section 10C.09 Light Rail Transit Only Lane Signs (R15-4 Series)**Support:**

The Light Rail Transit Only Lane (R15-4 series) signs are used for multi-lane operations, where roadway users might need additional guidance on lane use and/or restrictions.

Option:

Light Rail Transit Only Lane signs may be used on a roadway lane limited to only light rail transit use to indicate the restricted use of a lane in semi-exclusive and mixed alignments.

Guidance:

If used, the R15-4a, R15-4b, and R15-4c signs should be installed on posts adjacent to the roadway containing the light rail transit tracks or overhead above the light rail transit only lane.

Option:

If the trackway is paved, preferential lane markings (see Section 3B.22) may be installed but only in combination with light rail transit only lane signs.

Support:

The trackway is the continuous way designated for light rail transit, including the entire dynamic envelope. Section 10C.15 contains more information regarding the dynamic envelope.

Section 10C.10 Do Not Pass Light Rail Transit Signs (R15-5, R15-5a)**Support:**

A Do Not Pass Light Rail Transit (R15-5) sign is used to indicate that vehicles are not allowed to pass light rail transit vehicles that are loading or unloading passengers where there is no raised platform or physical separation from the lanes upon which other motor vehicles are operating.

Option:

The R15-5 sign may be used in mixed-use alignments and may be mounted overhead where there are multiple lanes.

Instead of the R15-5 symbol sign, a regulatory sign with the word message DO NOT PASS STOPPED TRAIN (R15-5a) may be used.

Guidance:

If used, the R15-5 sign should be located immediately before the light rail transit boarding area.



R15-5



R15-5a



W10-1

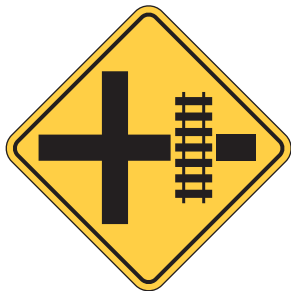

W10-2

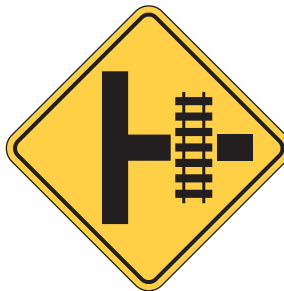

W10-3

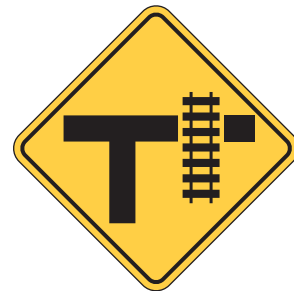

W10-4



W10-7
Activated Blank-Out



I-12

Section 10C.11 Highway-Rail Advance Warning Signs (W10 Series)**Standard:**

A Highway-Rail Advance Warning sign (W10-1) shall be used on each highway in advance of every highway-light rail grade crossing except in the following circumstances:

- A. On low-volume, low-speed highways crossing minor spurs or other tracks that are infrequently used and are flagged by train/transit crews.**
- B. In business districts where active highway-light rail grade crossing traffic control devices are in use.**

Placement of the Highway-Rail Advance Warning sign shall be in accordance with Chapter 2A and Table 2C-4.

Option:

On divided highways and one-way streets, an additional W10-1 sign may be installed on the left side of the roadway.

W10-2, W10-3, or W10-4 signs may be installed on highways that run parallel to light rail transit to warn road users making a turn that they will encounter a highway-light rail transit grade crossing soon after making the turn.

Standard:

If the W10-2, W10-3, or W10-4 signs are used, sign placement shall be in accordance with Table 2C-4 (using the speed of the turning maneuver), and shall be measured from the highway intersection.

Guidance:

If the distance between the track and the parallel highway, from the edge of the track to the edge of the roadway, is 30 m (100 ft) or more, a W10-1 sign should be installed in advance of the highway-light rail transit grade crossing, and the W10-2, W10-3, or W10-4 signs should not be used on the parallel highway.

Support:

Where the distance between the track and the parallel highway, from edge of track to edge of highway, is less than 30 m (100 ft), it is not necessary to install a W10-1 sign if the W10-2, W10-3, or W10-4 signs are used on the parallel highway.

Section 10C.12 Light Rail Transit Approaching-Activated Blank-Out Warning Sign (W10-7)

Support:

The Light Rail Transit Approaching-Activated Blank-Out warning (W10-7) sign supplements the traffic control signal to warn road users turning across the tracks of an approaching parallel light rail transit vehicle.

Option:

A Light Rail Transit Approaching-Activated Blank-Out warning sign may be used at signalized intersections near grade crossings or at crossings controlled by STOP signs or automatic gates.

Section 10C.13 Light Rail Station Sign (I-12)

Option:

The Light Rail Station (I-12) sign may be used to direct road users to a light rail station or boarding location. It may be supplemented by the name of the transit system and by arrows as provided in Section 2D.08.

Section 10C.14 Illumination at Highway-Light Rail Transit Crossings

Guidance:

Where light rail transit operations are conducted at night, illumination at and adjacent to the highway-light rail transit grade crossing should be considered.

Support:

Recommended types and location of luminaires for highway-railroad (light rail transit) grade crossings are contained in the American National Standards Institute's (ANSI) "Practice for Roadway Lighting RP-8," available from the Illuminating Engineering Society (see Section 1A.11).

Section 10C.15 Dynamic Envelope Delineation Markings

Support:

The dynamic envelope delineation markings indicate the clearance required for the light rail transit car overhang resulting from any combination of loading, lateral motion, or suspension failure (see Figure 10C-1).

Figure 10C-1. Light Rail Transit Vehicle Dynamic Envelope

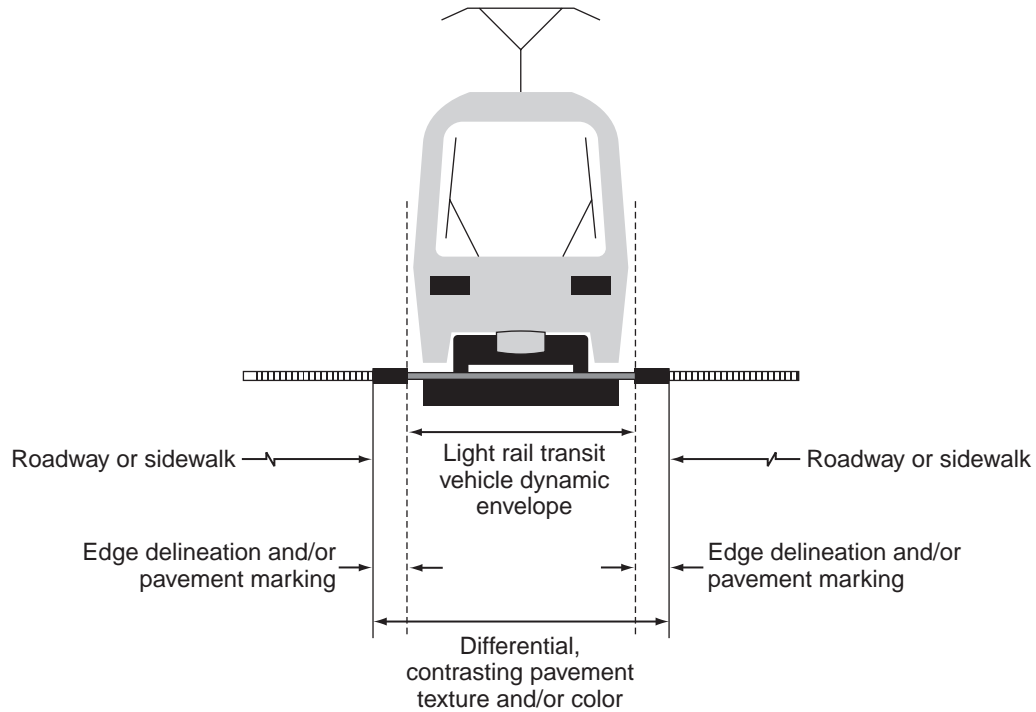
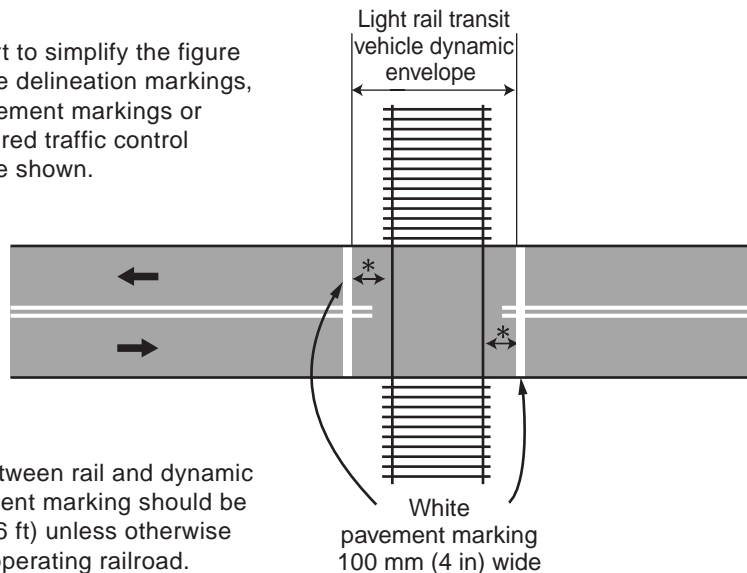

Figure 10C-2. Typical Light Rail Transit Vehicle Dynamic Envelope Delineation Pavement Markings

Note: In an effort to simplify the figure to show the delineation markings, not all pavement markings or other required traffic control devices are shown.



* The distance between rail and dynamic envelope pavement marking should be equal to 1.8 m (6 ft) unless otherwise advised by the operating railroad.

Legend
 → Direction of travel

Option:

The dynamic envelope may be delineated on the pavement using pavement markings (see Figures 10C-2 and 10C-3) or contrasting pavement color and/or contrasting pavement texture (see Figure 10C-4).

Standard:

If pavement markings are used for indicating the dynamic envelope delineation, they shall conform to Part 3 and shall be a 100 mm (4 in) normal solid white line.

Guidance:

If pavement markings are used to convey the dynamic envelope, they should be placed completely outside of the dynamic envelope. If used at light-rail transit grade crossings, dynamic envelope pavement markings should be placed on the highway 1.8 m (6 ft) from the nearest rail and installed parallel to the tracks, unless the transit authority and/or operating railroad company advises otherwise. The pavement markings should extend across the roadway as shown in Figure 10C-2.

Option:

In semi-exclusive alignments, the dynamic envelope may be delineated along the light rail transit trackway between intersections where the trackway is immediately adjacent to travel lanes and no physical barrier is present.

In mixed-use alignments the dynamic envelope may be delineated continuously between intersections.

Dynamic envelope markings may be installed at all highway-light rail transit grade crossings, unless a four-quadrant gate system (see Section 10D.02) is used.

Pavement markings for adjacent travel or parking lanes may be used instead of dynamic envelope delineation if the lines are outside the dynamic envelope.

Figure 10C-3. Typical Light Rail Transit Car Dynamic Envelope Delineation Pavement Markings

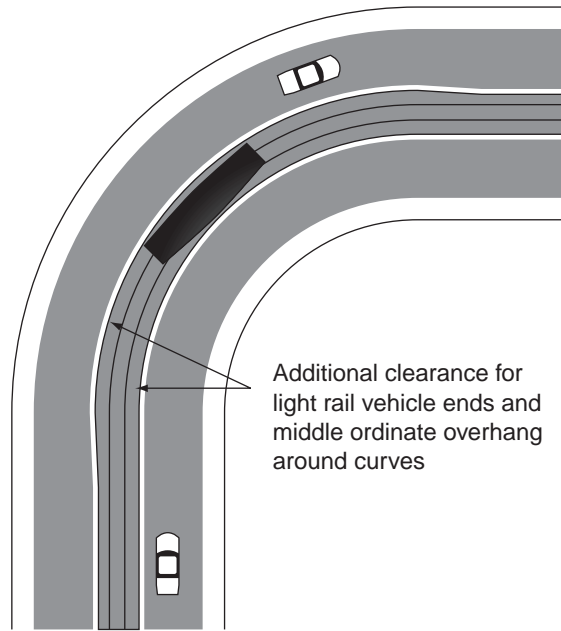
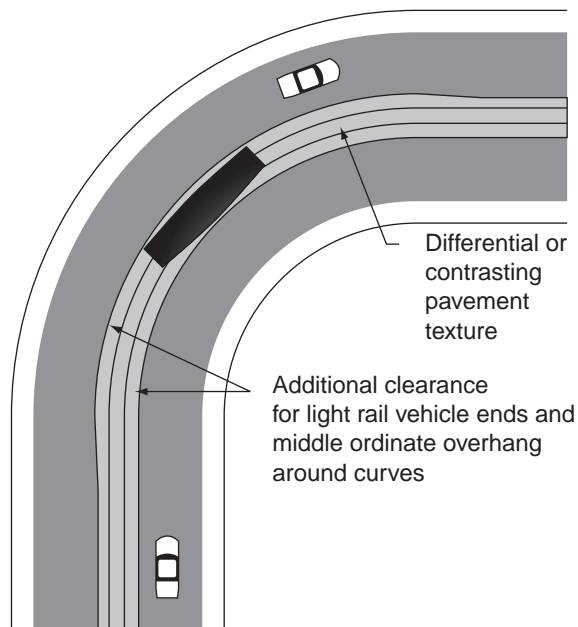

Figure 10C-4. Typical Light Rail Transit Vehicle Dynamic Envelope Delineation Contrasting Pavement Texture



CHAPTER 10D. HIGHWAY-LIGHT RAIL TRANSIT ACTIVE TRAFFIC CONTROL GRADE CROSSING SYSTEMS

Section 10D.01 Introduction

Support:

Active light rail transit traffic control systems inform drivers, bicyclists, and pedestrians of the approach or presence of light rail transit at highway-light rail transit grade crossings. These systems include four-quadrant gate systems, automatic gates, flashing-light signals, traffic control signals, actuated blank-out and variable message signs, and other active traffic control devices.

Standard:

Where light rail transit and railroads use the same tracks or adjacent tracks, the traffic control devices, systems, and practices for highway-rail grade crossings described in Part 8 shall be used.

Guidance:

Where both traffic control signals and flashing-light signals (with or without traffic gates) are in operation at the same highway-light rail transit grade crossing, the operation of the devices should be coordinated to avoid any display of conflicting signal indications.

If a pedestrian route is provided, sufficient clearance from supports, posts, and gate mechanisms should be maintained for pedestrian travel.

Option:

Audible devices may be operated in conjunction with the flashing lights or traffic control signals.

Support:

Light rail transit typically operates through grade crossings in semi-exclusive and mixed-use alignments at speeds between 15 km/h (10 mph) and 105 km/h (65 mph).

When light rail transit speed is cited in this Part, it refers to the maximum speed at which light rail transit cars are permitted to traverse a particular grade crossing.

Section 10D.02 Four-Quadrant Gate Systems

Option:

Four-Quadrant Gate systems may be installed to improve safety at highway-light rail transit grade crossings based on an engineering study when less restrictive measures, such as automatic gates and channelization devices, are not effective.

Standard:

A Four-Quadrant Gate system shall consist of a series of automatic gates used as an adjunct to flashing-light signals to control traffic on all lanes at the highway-light rail transit grade crossing.

The Four-Quadrant Gate system shall consist of a drive mechanism and fully retroreflectorized red- and white-striped gate arms with lights, and which in the down position extends individually across the approaching and exit lanes of highway traffic as shown in Figure 8D-2. Standards contained in Sections 8D.01 through 8D.03 for flashing-light signals shall be followed for signal specifications, location, and clearance distances.

In the normal sequence of operation, the flashing-light signals and the lights on the gate arms (in their normal upright positions) shall be activated immediately upon detection of the approaching light rail transit vehicle. The gate arms for the approaching lanes of traffic shall start their downward motion not less than 3 seconds after the flashing-light signals start to operate and shall reach their horizontal position at least 5 seconds before the arrival of the light rail transit vehicle. Exit lane gate arm activation and downward motion shall be based on timing requirements established by an engineering study of the individual site. The gate arms shall remain down as long as the light rail transit vehicle occupies the highway-light rail transit crossing.

When the light rail transit vehicle clears the highway-light rail transit grade crossing, and no other light rail transit vehicle is detected, the gate arms shall ascend to their upright positions, following which the flashing lights and the lights on the gate shall cease operation.

Gate arm design, colors, and lighting requirements shall be in accordance with the Standards contained in Section 8D.04.

The exit lane gate arms shall be designed to fail-safe in the up position.

At locations where gate arms are offset a sufficient distance for vehicles to drive between the entrance and exit gate arms, median islands shall be installed in accordance with needs established by an engineering study.

Guidance:

The gate arm should ascend to its upright position in not more than 12 seconds.

Four-Quadrant Gate systems should only be used in locations with constant-warning-time light rail transit vehicle detection.

Where an engineering study determines the need, vehicle intrusion detection devices should be installed at the crossing.

At locations where sufficient space is available, exit gates should be set back from the track a distance that provides a zone long enough to accommodate at least one design vehicle between the exit gate and the nearest rail.

Four-Quadrant Gate systems should include remote health (status) monitoring capable of automatically notifying railroad signal maintenance personnel when anomalies have occurred within the system.

Option:

Exit lane gate arms may fail in the down position if the highway-rail grade crossing is equipped with remote health (status) monitoring.

Four-Quadrant Gate system installations may include median islands between opposing lanes on an approach to a highway-light rail transit grade crossing.

Guidance:

Where sufficient space is available, median islands should be at least 18 m (60 ft) in length.

Section 10D.03 Automatic Gates**Support:**

An automatic gate is a traffic control device used as an adjunct to flashing-light signals.

Section 8D.04 contains further details regarding automatic gates.

Guidance:

Highway-light rail transit grade crossings in semi-exclusive alignments should be equipped with automatic gates and flashing-light signals (see Chapter 8D) where light rail transit speeds exceed 60 km/h (35 mph).

Option:

Where the crossing is at a location other than an intersection, where light rail transit speeds exceed 40 km/h (25 mph), automatic gates and flashing-light signals may be installed.

Traffic control signals may be used instead of automatic gates at highway-light rail transit grade crossings within highway-highway intersections where light rail transit speeds do not exceed 60 km/h (35 mph). Traffic control signals or flashing-light signals without traffic gates may be used where the crossing is at a location other than an intersection and where light rail transit speeds do not exceed 40 km/h (25 mph) and the roadway is a low-volume street where prevailing speeds do not exceed 40 km/h (25 mph).

Traffic gates may be supplemented by cantilevered flashing-light signals (see Figure 8D-1) where there is a need for additional emphasis or better visibility.

Support:

The effectiveness of gates can be enhanced by the use of channelizing devices or raised median islands to discourage driving around lowered automatic gates.

Section 10D.04 Flashing-Light Signals**Support:**

Sections 8D.02 and 8D.03 contain additional details regarding flashing-light signals.

Standard:

Highway-light rail transit grade crossings in semi-exclusive alignments shall be equipped with flashing-light signals where light rail transit speeds exceed 60 km/h (35 mph). Flashing-light signals shall be clearly visible to drivers, pedestrians, and bicyclists.

Guidance:

Where the crossing is at a location other than an intersection, where light rail transit speeds exceed 40 km/h (25 mph), flashing light signals should be installed.

Option:

Traffic control signals may be used instead of flashing-light signals at highway-light rail transit grade crossings within highway-highway intersections where light rail transit speeds do not exceed 60 km/h (35 mph). Traffic control signals or flashing-light signals may be used where the crossing is at a location other than an intersection, where light rail transit speeds do not exceed 40 km/h (25 mph), and when the roadway is a low-volume street where prevailing speeds do not exceed 40 km/h (25 mph).

Section 10D.05 Traffic Control Signals

Support:

There are two types of signals for controlling vehicular and light rail transit movements at interfaces of the two modes. The first is the standard traffic control signal described in Part 4, which is the focus of this section. The other type of signal is referred to as a light rail transit signal and is discussed in Section 10D.07.

Standard:

The provisions of Parts 4 and 8 relating to traffic control signal design, installation, and operation, including interconnection with nearby traffic gates or flashing-light signals, shall be applicable as appropriate where traffic control signals are used at highway-light rail transit grade crossings.

Guidance:

When a highway light-rail transit grade crossing equipped with a flashing-light signal system is located within 60 m (200 ft) of an intersection or mid-block location controlled by a traffic control signal, the traffic control signal should be provided with preemption in accordance with Section 4D.13.

Coordination with the flashing-light signal system should be considered for traffic control signals located more than 60 m (200 ft) from the crossing. Factors to be considered should include traffic volumes, vehicle mix, vehicle and light rail transit approach speeds, frequency of light rail transit vehicles, and queue lengths.

If the traffic signal has emergency vehicle preemption capability, it should be coordinated with light rail transit operation.

Where light rail transit operates in a wide median, vehicles crossing the tracks and being controlled by both near and far side traffic signals should receive a protected left-turn green phase from the far side signal to clear vehicles from the crossing when light rail transit vehicles are approaching the crossing.

Option:

Green indications may be provided during light rail transit phases for vehicle, pedestrian, and bicycle movements that do not conflict with light rail transit movements.

Traffic control signals may be installed in addition to four-quadrant gate systems and automatic gates at a highway-light rail transit crossing if the crossing occurs within a highway-highway intersection and if the traffic control signals meet the warrants described in Chapter 4C.

At a location other than an intersection, when light rail transit speeds are less than 40 km/h (25 mph), traffic control signals alone may be used to control roadway users at highway-light rail transit grade crossings only when justified by an engineering study.

Typical circumstances may include:

- A. Geometric conditions preclude the installation of highway-light rail transit grade crossing warning devices.
- B. Light rail transit vehicles share the same roadway with road users.
- C. Traffic control signals already exist.

Support:

See Section 4D.13 for considerations regarding traffic control signals at or near highway-light rail transit grade crossings that are not equipped with highway-light rail transit grade crossing warning devices.

Section 10D.06 Traffic Signal Preemption Turning Restrictions

Guidance:

When a light rail transit grade crossing exists within a signalized intersection, consideration should be given to providing separately-controlled Protected Only Mode turn phases for the movements crossing the tracks.

Standard:

Signal faces that are provided for separately-controlled Protected Only Mode turn movements toward the crossing shall display a red indication during the approach and/or passage of light rail transit vehicles.

Guidance:

When a signalized intersection that is located within 60 m (200 ft) of a highway-light rail transit grade crossing is preempted, all existing turning movements toward the highway-light rail transit grade crossing should be prohibited.

Support:

Part 4 contains information regarding signal phasing and timing requirements.

Option:

An activated blank-out or changeable message sign and/or an appropriate traffic signal display may be used to prohibit turning movements toward the crossing during preemption.

Standard:

Messages on the activated blank-out or changeable message signs shall be visible only when the highway-light rail transit intersection restriction is in effect.

Section 10D.07 Use of Traffic Control Signals for Control of Light Rail Transit Vehicles at Grade Crossings**Guidance:**

Light rail transit movements in semi-exclusive alignments at non-gated grade crossings that are equipped with traffic control signals should be controlled by special light rail transit signal indications.

Support:

Typical light rail transit traffic control signals, used to control light rail transit movements only, are shown in Figure 10D-1.

Option:

Standard traffic control signals may be used in lieu of light rail transit traffic control signals to control the movement of light rail transit vehicles (see Section 10D.05).

Standard:

































If a separate set of standard traffic control signal indications (red, yellow, and green circular and arrow indications) is used to control light rail transit movements, the indications shall be positioned so they are not visible to drivers, pedestrians, and bicyclists (see Section 4D.17).

If the light rail transit crossing control is separate from the intersection control, the two shall be interconnected. The light rail phase shall not be terminated until after the light rail transit vehicle has cleared the crossing.

Option:

Light rail transit signals may be used at grade crossings and at intersections in mixed-use alignments in conjunction with standard traffic control signals where special light rail transit signal phases are used to accommodate turning light rail transit vehicles or where additional light rail transit clearance time is desirable.

Figure 10D-1. Typical Light Rail Transit Signals

	Three-Lens Signal	Two-Lens Signal
<p>SINGLE LRT ROUTE</p> 	<p>STOP </p> <p>PREPARE TO STOP  <i>Flashing</i></p> <p>GO </p>	<p> STOP</p> <p>⁽²⁾ GO</p>
<p>TWO LRT ROUTE DIVERSION</p> 	<p></p> <p> <i>Flashing</i></p> <p> ⁽¹⁾</p>	<p></p> <p> ^{(1),(2)}</p>
	<p></p> <p><i>Flashing</i> </p> <p> ⁽¹⁾</p>	<p></p> <p> ^{(1),(2)}</p>
<p>THREE LRT ROUTE DIVERSION</p> 	<p></p> <p> <i>Flashing</i></p> <p>  ⁽¹⁾</p>	<p></p> <p>  ^{(1),(2)}</p>

Notes:

All aspects are white.

(1) Could be in single housing.

(2) "Go" lens may be used in flashing mode to indicate "prepare to stop".

Guidance:

Light rail transit signal heads should be separated vertically or horizontally from the nearest traffic signal head for the same approach by at least 1 m (3 ft).

Section 10D.08 Pedestrian and Bicycle Signals and Crossings**Standard:**

Pedestrian signals shall be in accordance with Section 4E.04.

Guidance:

Where light rail transit tracks are immediately adjacent to other tracks or a road, pedestrian signalization should be designed to avoid having pedestrians wait between sets of tracks or between the tracks and the road. If adequate space exists for a pedestrian refuge and is justified based on engineering judgment, additional pedestrian signal indicators, signing, and detectors should be installed (see Section 4E.07).

Flashing-light signals (see Figure 10D-2) with a Crossbuck (R15-1) sign should be installed at pedestrian and bicycle crossings where an engineering study has determined that the sight distance is not sufficient for pedestrians and bicyclists to complete their crossing prior to the arrival of the light rail transit vehicle at the crossing, or where light rail transit speeds exceed 60 km/h (35 mph).

Option:

If an engineering study shows that flashing-light signals alone would not provide sufficient notice of an approaching light rail transit vehicle, the LOOK (R15-8) sign (see Figure 10D-2) and/or pedestrian gates may be considered (see Figures 10D-3, 10D-4, and 10D-5).

Support:

A pedestrian gate is similar to an automatic gate except the gate arm is shorter.

The swing gate alerts pedestrians to the light rail transit tracks that are to be crossed. Swing gates are designed to open away from the tracks, requiring users to pull the gate open to cross, but permitting a quick exit from the trackway, and to automatically close.

Option:

Swing gates may be installed across pedestrian and bicycle walkways (see Figure 10D-6).

Pedestrian barriers at offset crossings may be used at pedestrian and bicycle crossings as passive devices that force users to face approaching light rail transit before entering the trackway (see Figures 10D-7 and 10D-8).

Figure 10D-2. Typical Light Rail Transit Flashing-Light Signal Assembly for Pedestrian Crossings

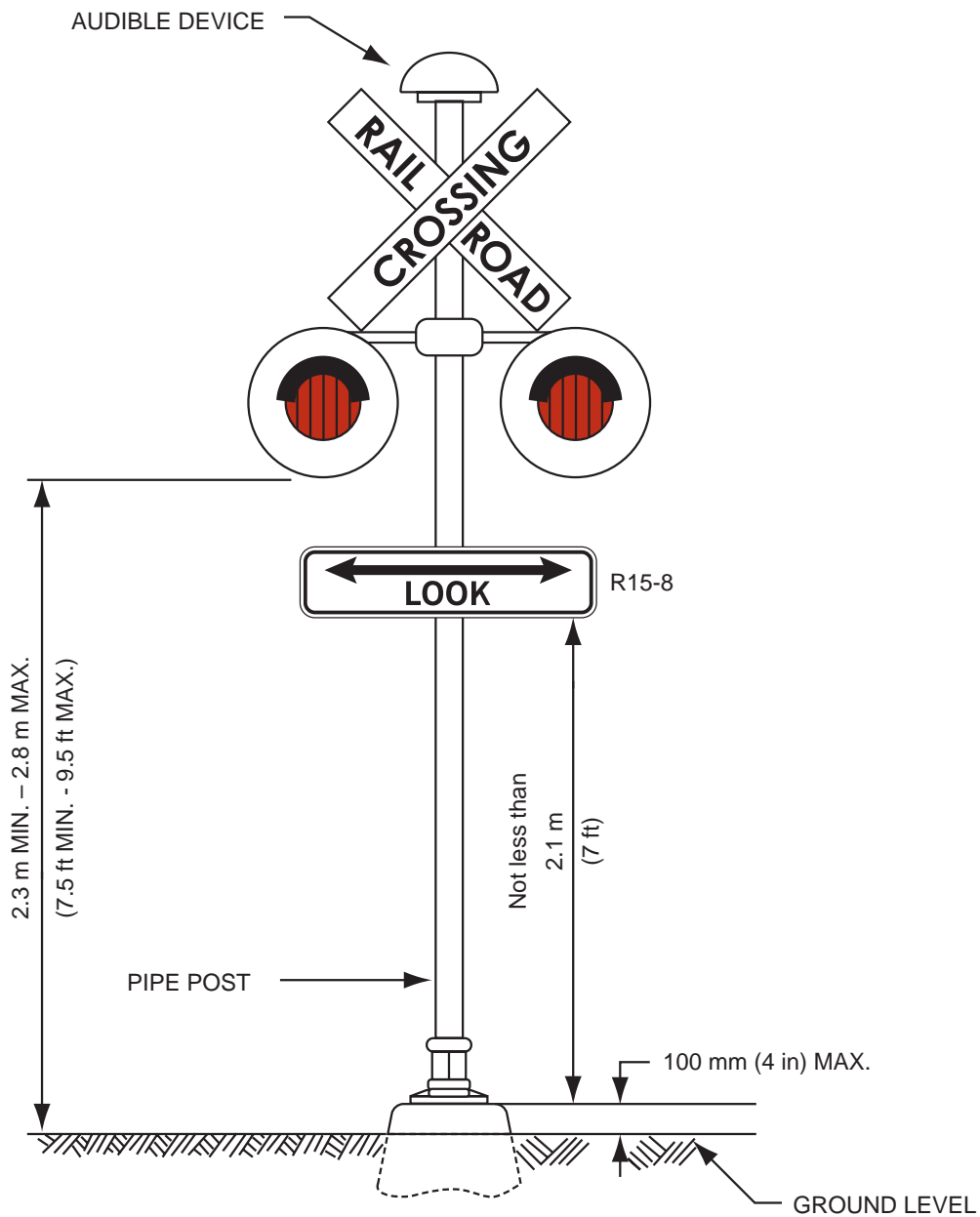

Figure 10D-3. Typical Pedestrian Gate Placement Behind the Sidewalk

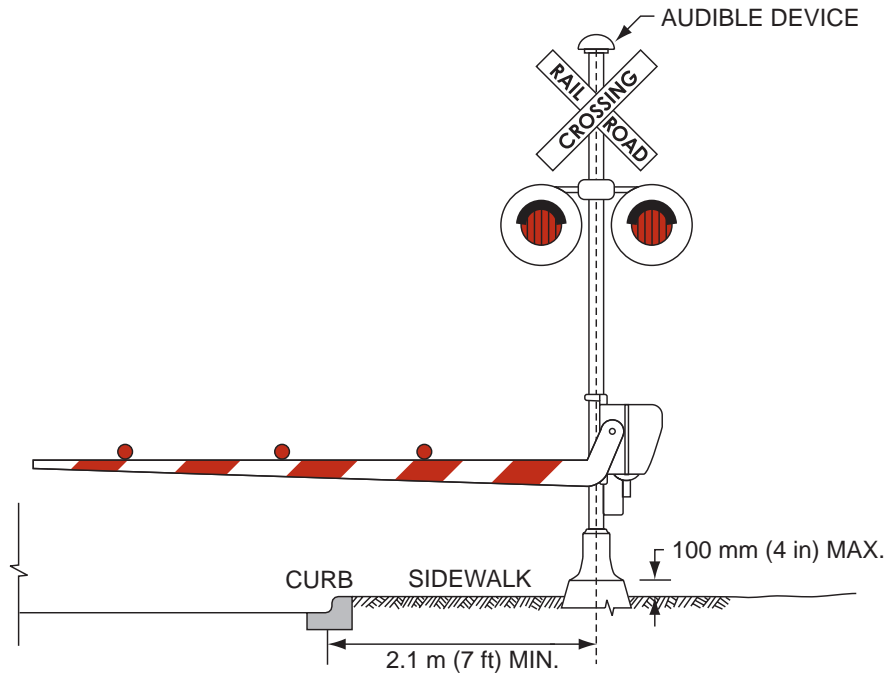

Figure 10D-4. Typical Pedestrian Gate Placement with Pedestrian Gate Arm

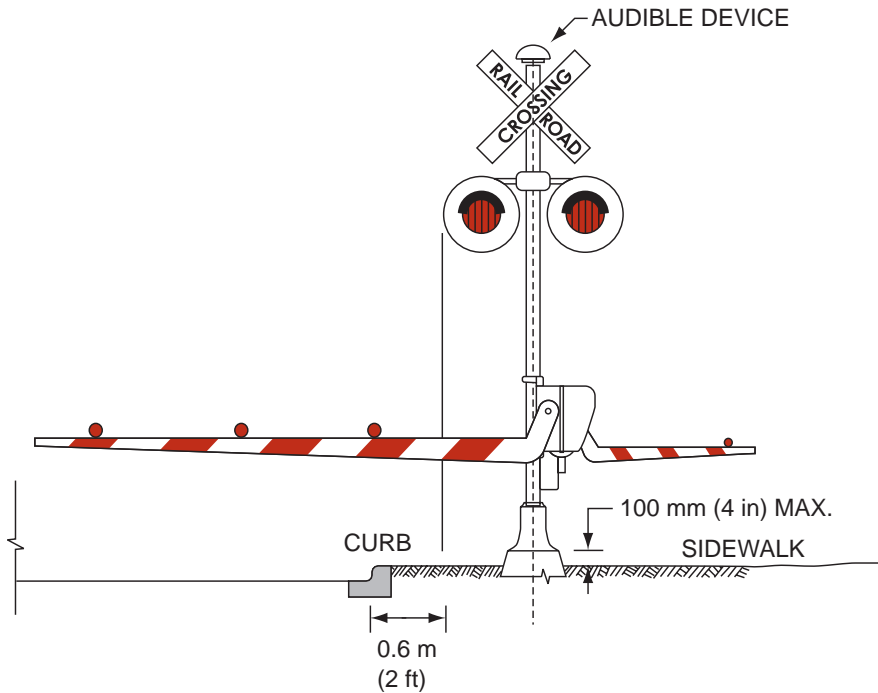
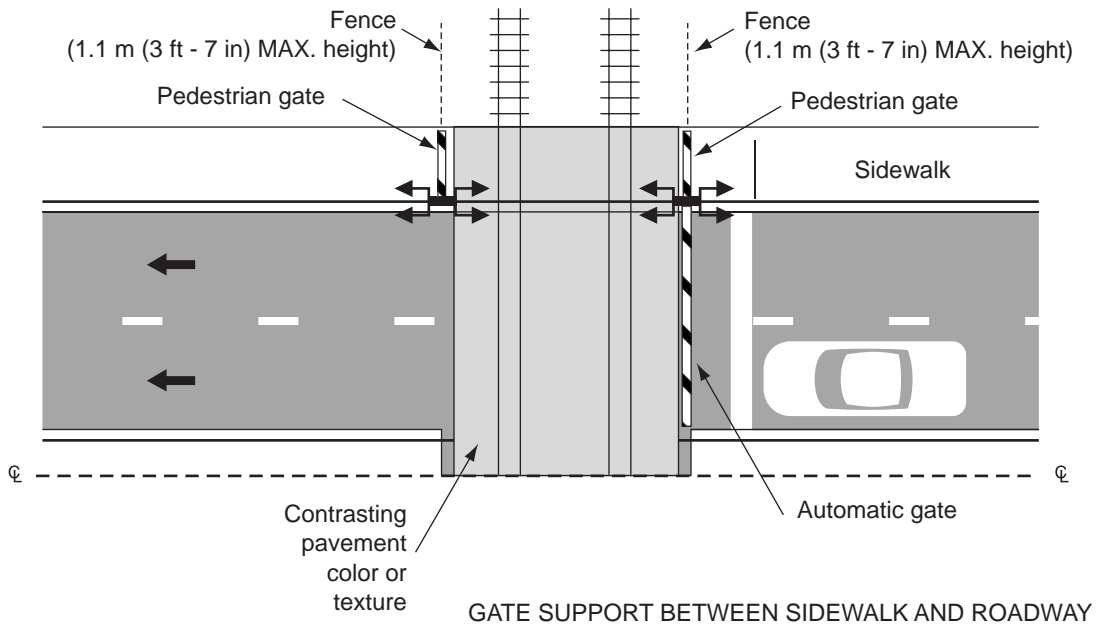
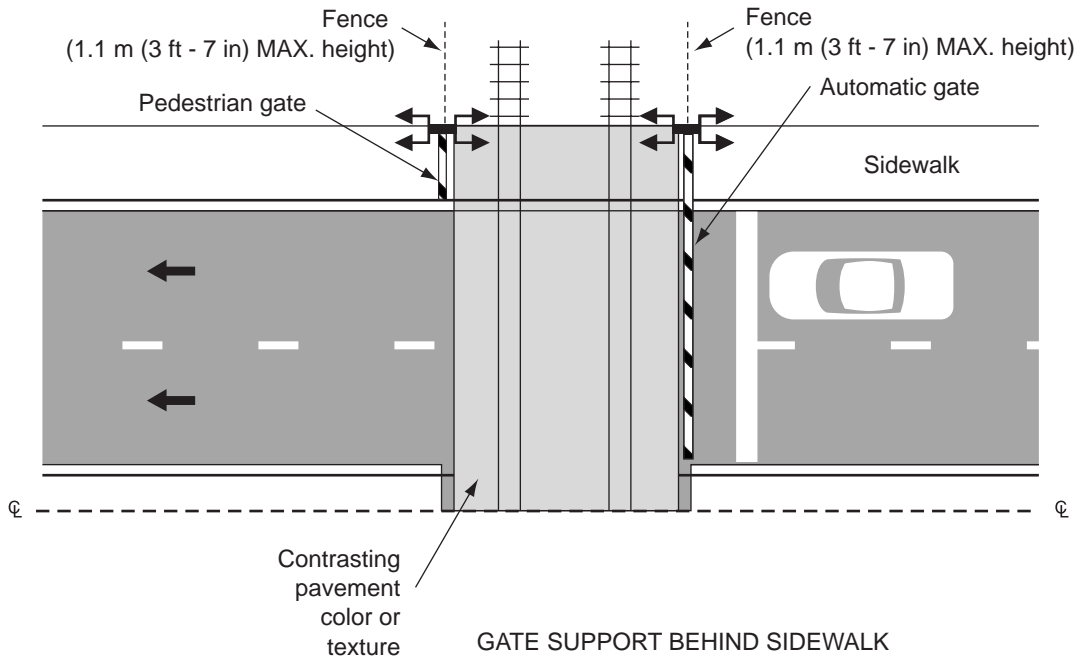

Figure 10D-5. Typical Placement of Pedestrian Traffic Gates



Legend
 → Direction of travel

Figure 10D-6. Typical Swing Gates

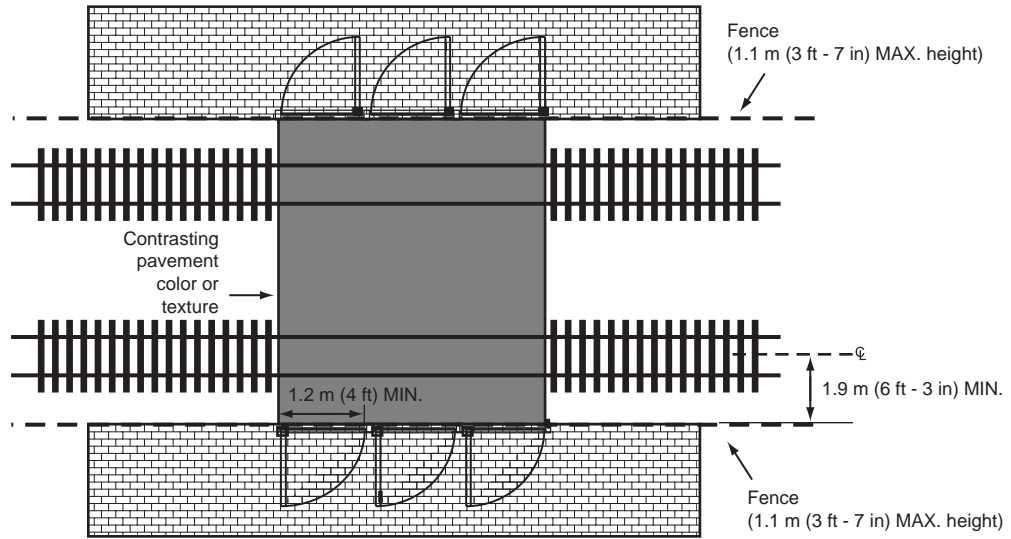

Figure 10D-7. Typical Pedestrian Barriers at an Offset Highway — Light Rail Transit Crossing

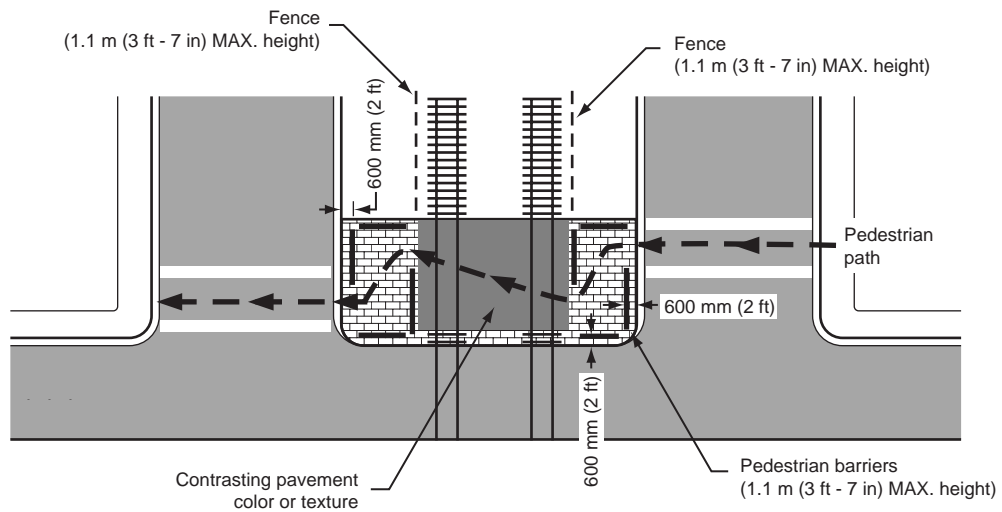
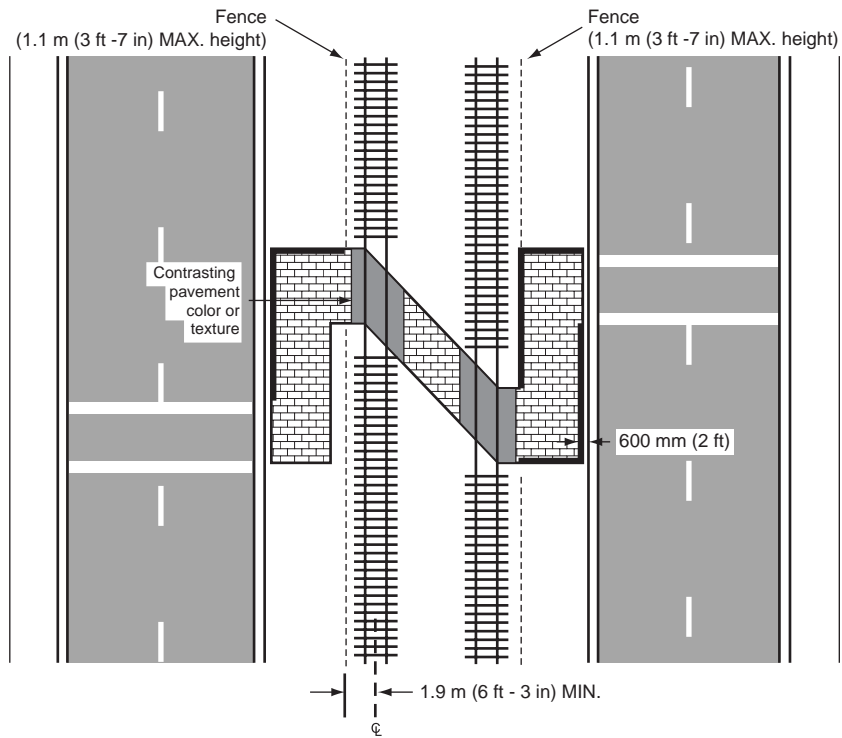
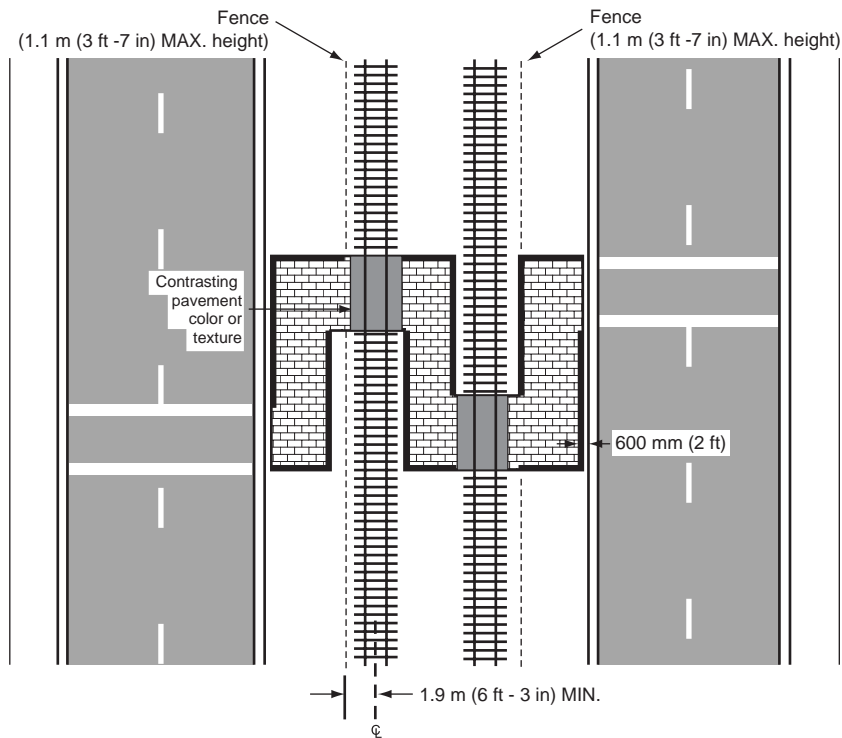

Figure 10D-8. Typical Examples of Pedestrian Barrier Installation at an Offset Non-Intersection Light Rail Transit Crossing





APPENDIX A1

Congressional Legislation

MUTCD 2000

Manual on Uniform Traffic Control Devices

m i l l e n n i u m e d i t i o n

December 2000



U.S. Department
of Transportation

**Federal Highway
Administration**

CONGRESSIONAL LEGISLATION

PUBLIC LAW 102-240-DEC. 18, 1991 (INTERMODAL SURFACE TRANSPORTATION EFFICIENCY ACT OF 1991)

Section 1077. REVISION OF MANUAL – Not later than 90 days after the date of the enactment of this Act, the Secretary shall revise the Manual of Uniform Traffic Control Devices and such other regulations and agreements of the Federal Highway Administration as may be necessary to authorize States and local governments, at their discretion, to install stop or yield signs at any rail-highway grade crossing without automatic traffic control devices with 2 or more trains operating across the rail-highway grade crossing per day.

PUBLIC LAW 102-388-OCT. 6, 1992 (DEPARTMENT OF TRANSPORTATION AND RELATED AGENCIES APPROPRIATIONS ACT, 1993)

Section 406 – The Secretary of Transportation shall revise the Manual of Uniform Traffic Control Devices to include –

- (a) a standard for a minimum level of retroreflectivity that must be maintained for pavement markings and signs, which shall apply to all roads open to public travel; and
- (b) a standard to define the roads that must have a centerline or edge lines or both, provided that in setting such standard the Secretary shall consider the functional classification of roads, traffic volumes, and the number and width of lanes.

PUBLIC LAW 104-59-NOV. 28, 1995 (NATIONAL HIGHWAY SYSTEM DESIGNATION ACT OF 1995)

Section 205. RELIEF FROM MANDATES –

(c) METRIC REQUIREMENTS –

(1) PLACEMENT AND MODIFICATION OF SIGNS – The Secretary shall not require the States to expend any Federal or State funds to construct, erect, or otherwise place or to modify any sign relating to a speed limit, distance, or other measurement on a highway for the purpose of having such sign establish such speed limit, distance, or other measurement using the metric system.

(2) OTHER ACTIONS – Before September 30, 2000, the Secretary shall not require that any State use or plan to use the metric system with respect to designing or advertising, or preparing plans, specifications, estimates, or other documents, for a Federal-aid highway project eligible for assistance under title 23, United States Code.

(3) DEFINITIONS – In this subsection, the following definitions apply:

(A) **HIGHWAY** – The term ‘highway’ has the meaning such term has under section 101 of title 23, United State Code.

(B) **METRIC SYSTEM** – the term ‘metric system’ has the meaning the term ‘metric system of measurement’ has under section 4 of the Metric Conversion Act of 1975 (15 U.S.C. 205c).

Section 353(a) SIGNS – Traffic control signs referred to in the experimental project conducted in the State of Oregon in December 1991 shall be deemed to comply with the requirements of Section 2B-4 of the Manual on Uniform Traffic Control Devices of the Department of Transportation.

Section 353(b) STRIPES – Notwithstanding any other provision of law, a red, white, and blue center line in the Main Street of Bristol, Rhode Island, shall be deemed to comply with the requirements of Section 3B-1 of the Manual on Uniform Traffic Control Devices of the Department of Transportation.